



Revision C
January 2012
Copyright © 2011
by AMETEK Programmable Power.
All rights reserved.
P/N M162084

California Instruments
CSW Series
AC Power Source
User Manual

User's Manual
California Instruments AC Power Source
By AMETEK Programmable Power.

Models :

- CSW5550
- CSW5550-400
- CSW11100
- CSW11100-400
- CSW16650
- CSW16650-400
- CSW22200
- CSW22200-400
- CSW27750
- CSW27750-400
- CSW33300
- CSW33300-400
- CSW38850
- CSW38850-400
- CSW44400
- CSW44400-400

•

© Copyright 2011 AMETEK Programmable Power. Rev C, January 2012.

About AMETEK

AMETEK Programmable Power, Inc., a Division of AMETEK, Inc., is a global leader in the design and manufacture of precision, programmable power supplies for R&D, test and measurement, process control, power bus simulation and power conditioning applications across diverse industrial segments. From bench top supplies to rack-mounted industrial power subsystems, AMETEK Programmable Power is the proud manufacturer of Elgar, Sorensen, California Instruments and Power Ten brand power supplies.

AMETEK, Inc. is a leading global manufacturer of electronic instruments and electromechanical devices with annualized sales of \$2.5 billion. The Company has over 11,000 colleagues working at more than 80 manufacturing facilities and more than 80 sales and service centers in the United States and around the world.

Trademarks

AMETEK is a registered trademark of AMETEK, Inc. California Instruments is a trademark owned by AMETEK, Inc. Other trademarks, registered trademarks, and product names are the property of their respective owners and are used herein for identification purposes only.

Notice of Copyright

CSW Series User Manual © 2011 AMETEK Programmable Power, Inc. All rights reserved.

Exclusion for Documentation

UNLESS SPECIFICALLY AGREED TO IN WRITING, AMETEK PROGRAMMABLE POWER, INC. ("AMETEK"):

- (a) MAKES NO WARRANTY AS TO THE ACCURACY, SUFFICIENCY OR SUITABILITY OF ANY TECHNICAL OR OTHER INFORMATION PROVIDED IN ITS MANUALS OR OTHER DOCUMENTATION.
- (b) ASSUMES NO RESPONSIBILITY OR LIABILITY FOR LOSSES, DAMAGES, COSTS OR EXPENSES, WHETHER SPECIAL, DIRECT, INDIRECT, CONSEQUENTIAL OR INCIDENTAL, WHICH MIGHT ARISE OUT OF THE USE OF SUCH INFORMATION. THE USE OF ANY SUCH INFORMATION WILL BE ENTIRELY AT THE USER'S RISK, AND
- (c) REMINDS YOU THAT IF THIS MANUAL IS IN ANY LANGUAGE OTHER THAN ENGLISH, ALTHOUGH STEPS HAVE BEEN TAKEN TO MAINTAIN THE ACCURACY OF THE TRANSLATION, THE ACCURACY CANNOT BE GUARANTEED. APPROVED AMETEK CONTENT IS CONTAINED WITH THE ENGLISH LANGUAGE VERSION, WHICH IS POSTED AT WWW.PROGRAMMABLEPOWER.COM.

Date and Revision

January 2012 Revision C

Part Number

M162084

Contact Information

Telephone: 800 733 5427 (toll free in North America)
858 450 0085 (direct)



Fax: 858 458 0267

Email: sales.ppd@programmablepower.com
service.ppd@programmablepower.com

Web: www.programmablepower.com

Important Safety Instructions

Before applying power to the system, verify that your product is configured properly for your particular application.

	<p>Hazardous voltages may be present when covers are removed. Qualified personnel must use extreme caution when servicing this equipment. Circuit boards, test points, and output voltages also may be floating above (below) chassis ground.</p>
	<p>The equipment used contains ESD sensitive parts. When installing equipment, follow ESD Safety Procedures. Electrostatic discharges might cause damage to the equipment.</p>

Only *qualified personnel* who deal with attendant hazards in power supplies, are allowed to perform installation and servicing.

Ensure that the AC power line ground is connected properly to the Power Rack input connector or chassis. Similarly, other power ground lines including those to application and maintenance equipment *must* be grounded properly for both personnel and equipment safety.













Always ensure that facility AC input power is de-energized prior to connecting or disconnecting any cable.

In normal operation, the operator does not have access to hazardous voltages within the chassis. However, depending on the user's application configuration, **HIGH VOLTAGES HAZARDOUS TO HUMAN SAFETY** may be normally generated on the output terminals. The customer/user must ensure that the output power lines are labeled properly as to the safety hazards and that any inadvertent contact with hazardous voltages is eliminated.

Guard against risks of electrical shock during open cover checks by not touching any portion of the electrical circuits. Even when power is off, capacitors may retain an electrical charge. Use safety glasses during open cover checks to avoid personal injury by any sudden component failure.

Neither AMETEK Programmable Power Inc., San Diego, California, USA, nor any of the subsidiary sales organizations can accept any responsibility for personnel, material or inconsequential injury, loss or damage that results from improper use of the equipment and accessories.

SAFETY SYMBOLS

	<p>WARNING Risk of Electrical Shock</p>		<p>CAUTION Refer to Accompanying Documents</p>
	<p>Off (Supply)</p>		<p>Direct Current (DC)</p>
	<p>Standby (Supply)</p>		<p>Alternating Current (AC)</p>
	<p>On (Supply)</p>		<p>Three-Phase Alternating Current</p>
	<p>Protective Conductor Terminal</p>		<p>Earth (Ground) Terminal</p>
	<p>Fuse</p>		<p>Chassis Ground</p>

Product Family: CSW Series Power Source**Warranty Period: 1 Year****WARRANTY TERMS**

AMETEK Programmable Power, Inc. (“AMETEK”), provides this written warranty covering the Product stated above, and if the Buyer discovers and notifies AMETEK in writing of any defect in material or workmanship within the applicable warranty period stated above, then AMETEK may, at its option: repair or replace the Product; or issue a credit note for the defective Product; or provide the Buyer with replacement parts for the Product.

The Buyer will, at its expense, return the defective Product or parts thereof to AMETEK in accordance with the return procedure specified below. AMETEK will, at its expense, deliver the repaired or replaced Product or parts to the Buyer. Any warranty of AMETEK will not apply if the Buyer is in default under the Purchase Order Agreement or where the Product or any part thereof:

- is damaged by misuse, accident, negligence or failure to maintain the same as specified or required by AMETEK;
- is damaged by modifications, alterations or attachments thereto which are not authorized by AMETEK;
- is installed or operated contrary to the instructions of AMETEK;
- is opened, modified or disassembled in any way without AMETEK’s consent; or
- is used in combination with items, articles or materials not authorized by AMETEK.

The Buyer may not assert any claim that the Products are not in conformity with any warranty until the Buyer has made all payments to AMETEK provided for in the Purchase Order Agreement.

PRODUCT RETURN PROCEDURE

Request a Return Material Authorization (RMA) number from the repair facility (**must be done in the country in which it was purchased**):

- **In the USA**, contact the AMETEK Repair Department prior to the return of the product to AMETEK for repair:
Telephone: 800-733-5427, ext. 2295 or ext. 2463 (toll free North America)
858-450-0085, ext. 2295 or ext. 2463 (direct)
- **Outside the United States**, contact the nearest Authorized Service Center (ASC). A full listing can be found either through your local distributor or our website, www.programmablepower.com, by clicking Support and going to the Service Centers tab.

When requesting an RMA, have the following information ready:

- Model number
- Serial number
- Description of the problem

NOTE: Unauthorized returns will not be accepted and will be returned at the shipper’s expense.

NOTE: A returned product found upon inspection by AMETEK, to be in specification is subject to an evaluation fee and applicable freight charges.

Table of Contents

1. Introduction	12
1.1 General Description	12
1.2 CSW Models	13
2. Specifications	14
2.1 Electrical	14
2.2 Mechanical	23
2.3 Environmental	23
2.4 Regulatory	24
2.5 Front Panel Controls	24
2.6 Special Features, Options and Accessories	25
2.7 Supplemental Specifications	26
3. Unpacking and Installation	27
3.1 Unpacking	27
3.2 Power Requirements	27
3.3 Mechanical Installation	28
3.4 Input Wiring – TB1	28
3.5 Output Power Connections – TB2	29
3.6 Connectors - Rear Panel	31
3.7 Single-Phase and Three Phase Multiple Box System Configurations	35
3.8 Output Voltage Ranges	36
3.9 Functional Test	36
4. Front Panel Operation	41
4.1 Tour of the Front Panel	41
4.2 Menu Structure	47
4.3 Output Programming	81
4.4 Waveform Management	83
4.5 Standard Measurements	87
4.6 Advanced Measurements	88
4.7 Transient Programming	97
5. Principle of Operation	102
5.1 General	102
5.2 Overall Description	102
5.3 Controller (A2) (7006-714)	102
5.4 Keyboard/Display Board (A1) (7006-716)	102
5.5 Remote Interface (A7) (7006-715)	102
5.6 Analog Board (A3) (5162062)	103
5.7 Auxiliary Power Supply (A8) (5162048)	103
5.8 PFC - DC/DC Module (A14, A15 and A16) (5161273)	105
5.9 Phase A, B and C Amplifiers (A17, A18, A19) (5161274-05)	107
5.10 Output Filter Board (A9) (5162063)	107
5.11 Circuit Breaker & Trip Circuit (A5)	107
6. Calibration	109
6.1 Calibration Equipment	109
6.2 Calibration Screen Access	109
6.3 Routine Calibration	110
6.4 Non-Routine Calibration	114
7. Service	116
7.1 Cleaning	116
7.2 General	116
7.3 Basic operation	116

8. Top Assembly Replaceable Parts	119
8.1 Sub assemblies	119
9. Options	120
9.1 RTCA/DO-160 Option	120
9.2 IEC 61000-4-11 Option	137
9.3 IEC 61000-4-13 Option	145
9.4 Option -704: MilStd704 Tests	157
9.5 ABD Option: Airbus ABD0100.1.8 Test	169
9.6 AMD Option: Airbus AMD24C Test	169
9.7 A350 Option: Airbus A350 (ABD0100.1.8.1) Test	169
9.8 787 Option: Boeing B787-0147 Test	169
9.9 WHM Option	170
10. Error Messages	173
11. Index	178

List of Figures

Figure 1-1 California Instruments CSW5550 (With Rack Mount Ears)	12
Figure 2-1: CSW5550 - Voltage Current rating	17
Figure 3-1:CSW5550	27
Figure 3-2:USB Connector pin orientation	33
Figure 3-3: Rear Panel View for the CSW5550)	35
Figure 3-4: Output Power Connections for 1 Source and Multi-source Systems	38
Figure 3-5: Functional Test Setup	39
Figure 3-6: Three CSW Sources, 9-phases with Clock/Lock	40
Figure 4-1: Shuttle Knob	42
Figure 4-2: FUNCTION keypad	43
Figure 4-3: Entering value from decimal keypad	44
Figure 4-4: Cursor UP key movement	45
Figure 4-5: Cursor DOWN key movement	45
Figure 4-6: Main Menu 1 screen	46
Figure 4-7: Menu 1 through 3	47
Figure 4-8: PROGRAM Menu	51
Figure 4-9: MEASUREMENTS Screen, single phase and three phase modes	53
Figure 4-10: HARMONICS/TRACE ANALYSIS screen	55
Figure 4-11: TRANSIENTS menu	58
Figure 4-12: VOLTAGE SURGE/SAG SETUP screen	59
Figure 4-13: VOLTAGE SWEEP/STEP SETUP screen	61
Figure 4-14: FREQUENCY SWEEP/STEP SETUP screen	63
Figure 4-15: VOLTAGE/FREQUENCY SWEEP/STEP SETUP screen	64
Figure 4-16: START/VIEW TRANSIENT SEQUENCE screen	65
Figure 4-17: WAVEFORMS menu	66
Figure 4-18: APPLICATIONS menu	68
Figure 4-19: SETUP REGISTERS menu	69
Figure 4-20: UTILITY menus	70
Figure 4-21: GPIB/RS232 SETUP menu	73
Figure 4-22: VOLTAGE/CURRENT CONTROL SETUP menu	74
Figure 4-23: INITIAL SETUP menus	75
Figure 4-24:LIMIT SETUP menu	76
Figure 4-25: CONFIGURATION SETUP Menus	77
Figure 4-26: MEASUREMENT CAL FACTORS menu	79
Figure 4-27: OUTPUT CAL FACTORS menu	79
Figure 4-28: Selecting a waveform	83
Figure 4-29: Selecting waveforms for single phase or all phases	83
Figure 4-30: Custom waveform creation with GUI program	84
Figure 4-31: Waveform crest factor affects max. rms voltage	85
Figure 4-32: Waveform frequency domain view mode	86
Figure 4-33: Scrolling through tabular FFT data	90
Figure 4-34: Scrolling through bar chart FFT data	90
Figure 4-35: Scrolling through acquired waveform data	92
Figure 4-36: SET VOLT trigger source acquisition	94
Figure 4-37: Positive trigger delay (Post trigger data)	95
Figure 4-38: Negative trigger delay (Pre-trigger data)	96
Figure 4-39: Pulse Transients	97
Figure 4-40: List Transients	98
Figure 4-41: Switching waveforms in a transient list	100
Figure 4-42: START/VIEW TRANSIENT SEQUENCE menu	101
Figure 5-1: Power Source Module Block Diagram	104
Figure 5-2: Internal Assembly Locations	106
Figure 6-1: Test Equipment Hook-up for Calibration	113
Figure 6-2: Front Panel Assembly Adjustment Location (Top View)	114
Figure 9-1: Application Menu	122
Figure 9-2: DO160 Main Menu	122
Figure 9-3: Normal state	123
Figure 9-4: Voltage Modulation	125
Figure 9-5: Frequency Modulation	126
Figure 9-6: Power Interrupt	127

Figure 9-7: Power Interrupt for Group 2 and 3	128
Figure 9-8: Emergency Screen	129
Figure 9-9: Abnormal Screen	131
Figure 9-10: DO-160 DC Main Menu	133
Figure 9-11: Normal State	133
Figure 9-12: Abnormal State	135
Figure 9-13: Application menu	139
Figure 9-14: IEC1000-4-11 Menu.....	139
Figure 9-15: IEC Dips and Interrupts.....	140
Figure 9-16: Voltage Variation screen.....	142
Figure 9-17: EN 61000-4-11 Voltage Variation specification- Edition 1.0.....	143
Figure 9-18: EN 61000-4-11 Voltage Variation specification- Edition 2.0.....	143
Figure 9-19: IEC 61000-4-11 GUI screen.	144
Figure 9-20: Application menu	146
Figure 9-21: IEC 61000-4-13 Menu.....	146
Figure 9-22: IEC 61000-4-13 FCurve.....	148
Figure 9-23: IEC 61000-4-13 OSwing	148
Figure 9-24: IEC 61000-4-13 Sweep.....	149
Figure 9-25: IEC 61000-4-13 Harmonics	150
Figure 9-26: IEC 61000-4-13 Inter harmonics	151
Figure 9-27: IEC 61000-4-13 Meister Curve	152
Figure 9-28: IEC 61000-4-13 Test Flowchart Class 1 and 2	153
Figure 9-29: IEC 61000-4-13 Test Flowchart Class 3	154
Figure 9-30: MENU 2 SCREEN	156
Figure 9-31: INTERHARMONICS SCREEN	156
Figure 9-32: Application Menu	159
Figure 9-33: MIL704 Menu	159
Figure 9-34: Steady State Menu	159
Figure 9-35: Transient Menu	162
Figure 9-36: Emergency Menu.....	163
Figure 9-37: Abnormal Screen	164
Figure 9-38: MIL704 DC Menu.....	165
Figure 9-39: Steady State DC	165
Figure 9-40: Transient Menu	166
Figure 9-41: Abnormal Test Screen	167
Figure 9-42: Emergency Test.....	168
Figure 9-43: Application Screen.....	170
Figure 9-44 Watt-Hour Meter Screen	170
Figure 9-45: WH-Meter Screen With Function Active.....	170

List of Tables

Table 3-1: Wire Sizes	30
Table 3-2: System Interface Connector (J32).....	31
Table 3-3: RS232 Connector pin out	33
Table 3-4: USB Connector pin out	33
Table 3-5: RJ45 LAN Connector pin out	34
Table 6-1: Load Values for Output Current Calibration.....	110
Table 6-2: External Signal Input Connector Pins	111
Table 6-3: AC/DC Zero Adjustment	115
Table 7-1: Basic Symptoms.....	116
Table 8-1: Replaceable Parts	119
Table 9-1: Normal Voltage and Frequency minimum	123
Table 9-2: Normal Voltage and Frequency Maximum	123
Table 9-3: Normal Voltage Unbalance.....	124
Table 9-4: Normal Voltage Surge Sequence	128
Table 9-5: Normal Frequency Transient Sequence	129
Table 9-6: Normal Frequency Variation Sequence.....	129
Table 9-7: Emergency Voltage and Frequency Minimum	130
Table 9-8: Emergency Voltage and Frequency Maximum	130
Table 9-9: Emergency Voltage Unbalance	130
Table 9-10: Abnormal Voltage Minimum	131
Table 9-11: Abnormal Voltage Maximum	131
Table 9-12: Abnormal Frequency Transient	132
Table 9-13: Normal Voltage Minimum	133
Table 9-14: Normal Voltage Maximum	134
Table 9-15: Voltage Surge.....	134
Table 9-16: Abnormal Voltage Surge	136
Table 9-17: Phase mapping	138
Table 9-18: IEC 61000-3-34 Table C.2.....	138
Table 9-19: Dips and Interruptions Tests Performed During RUN ALL	141
Table 9-20: Voltage Variations Test Performed During RUN ALL	142
Table 10-1: Error Messages.....	177

1. Introduction

This instruction manual contains information on the installation, operation, calibration and maintenance of all power systems that use the CSW5550.

This user manual also covers higher power configurations consisting of multiple units of the CSW5550 operated in parallel. Such models are the CSW11100, CSW16650, CSW22200, CSW27750, CSW33300, CSW38850 and CSW44400.

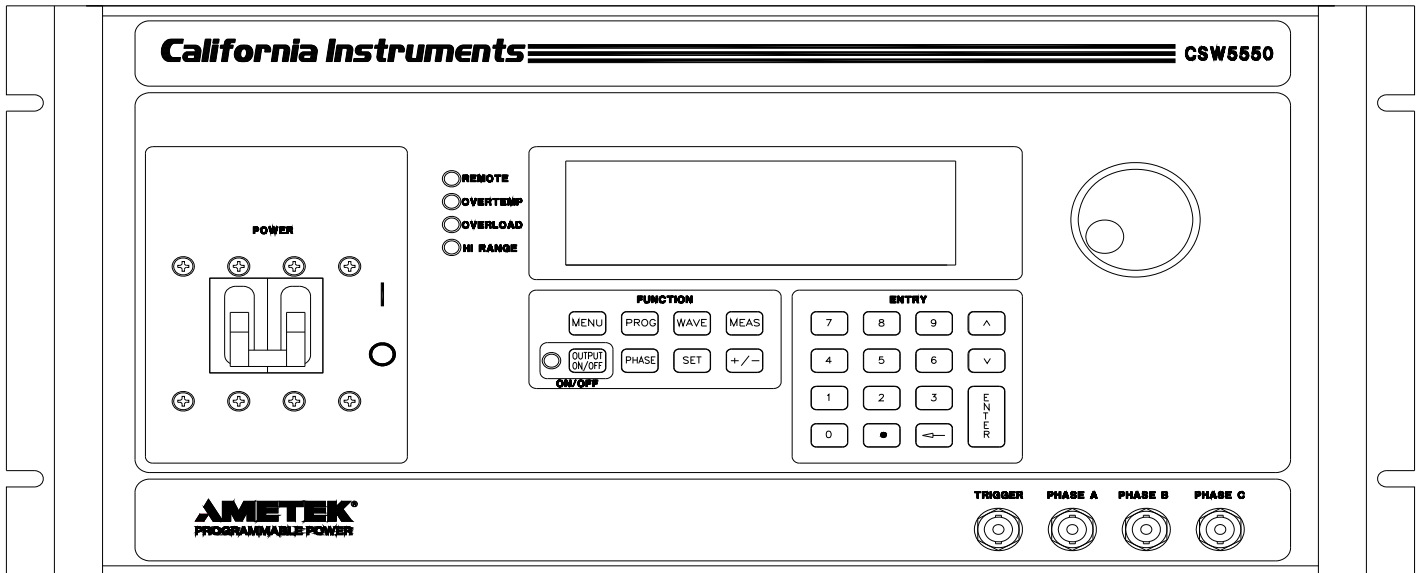

Figure 1-1 California Instruments CSW5550 (With Rack Mount Ears)

1.1 General Description

The CSW5550 is a high efficiency, lightweight AC power source that provides a precise output with low distortion. The CSW Series offers a 0-156/0-312 AC or DC voltage range. Full power is available from 115/230V to full-scale voltage using a constant power mode of operation.

Two to eight CSW5550 units can be connected in parallel as a single-phase or 3-phase power system for an output of up to 44.4 KVA. They can be operated with AC or DC output.

The CSW5550 Series also offers AC+DC output mode.

Remote Interfaces

The CSW5550 has the standard GPIB, RS232 and USB remote interfaces. The LAN (Ethernet) interface is offered as an option. With the LAN interface the RS232 interface will not be functional.

1.2 CSW Models

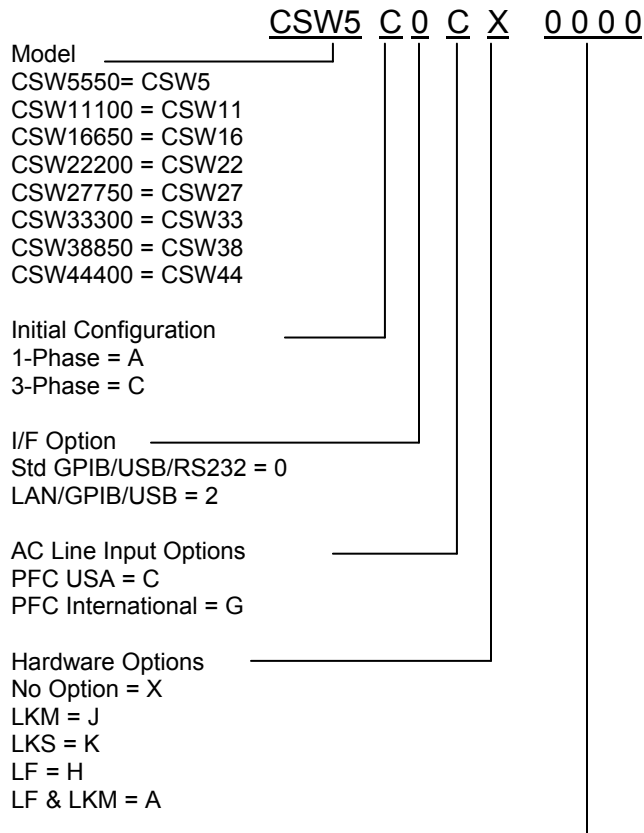

Firmware Options	CODE			
None	0	0	0	0
-RTCA/DO160	1	0	0	0
-IEC61000-4-11	0	4	0	0
-Mil Std 704	0	2	0	0
-704F	0	1	0	0
-A350	0	0	8	0
-ABD	0	0	4	0
-ABL	0	0	2	0
-AMD	0	0	0	8
-B787	0	0	0	4
-WHM	0	0	0	1
For multiple options use the HEX sum. For example A350 and ABD would be 00D0 Sum of 0 -9 = HEX 0 -9. Sum of 10 - 15 = HEX A - F				

2. Specifications

All specifications are for a single CSW5550 unit and $25 \pm 5^\circ\text{C}$ sine wave output with a resistive load unless noted otherwise.

2.1 Electrical

2.1.1 Input

Function	Specification
Input Power	Standard: 208 to 240V _{L-L} $\pm 10\%$, 3 ϕ , 3 wire or option: 380 to 415V _{L-L} $\pm 10\%$, 3 ϕ , 4 wire
Input Power Factor	0.99
Input Frequency Range	47 to 440 Hz
Efficiency	70% minimum at full-load
Ride-through or hold-up	10 mSec, minimum
Input Current	See Table below
Input Turn-on Current Surge	Limited to less than peak value of RMS listed in Tables below

	MAXIMUM LINE CURRENT	MAXIMUM NEUTRAL CURRENT	RECOMMENDED CIRCUIT BREAKER RATING (MAX.)
USA	27A RMS	Not Required	40A RMS
INTL	14A RMS	14A RMS	20A RMS

Input Currents for 3-Phase Input Power

REQ'D INPUT TERMINAL JUMPER CONNECTIONS		CONNECT 1-PHASE INPUT POWER TO	VOLTAGE	MAXIMUM INPUT CURRENT	RECOMMENDED CIRCUIT BREAKER RATING (MAX.)
USA	ØA to ØB	ØA, ØC	187-264 VRMS, L-L	30A RMS	40A RMS
INTL	ØA to ØB, ØB to ØC	ØA, Neutral	187-264 VRMS, L-N	45A RMS	40A RMS

* Only Phase A and Phase B are present at the output.

Single-Phase Input Configurations

2.1.2 Output

(ALL SPECIFICATIONS ARE FOR AC AND DC UNLESS NOTED OTHERWISE)

Function	Specification
Calibration Interval	1 year
Power Factor of Load	0 lagging to 0 leading
AC or DC Output Voltage	0 to 156 VRMS L-N range ; 0 to 312 VRMS L-N range
Output Current Per Phase	16A to 115V in 156V range; 8.0A to 230V in 312V range (1850 VA maximum). Multiply current by the number of sources in a multiple power source system
Crest Factor	3.25 (peak output current to RMS output current).
Output Frequency	DC, or 40 Hz to 5 kHz
Frequency Resolution (Without CLock/Lock option enabled)	16.00 - 81.91 Hz (0.01 Hz resolution) 81.0 – 819.1 Hz (0.1 Hz resolution) 820 – 5000 Hz (1 Hz resolution)
Frequency Accuracy:	$\pm 0.01\%$ at 25°C $\pm 0.001\%/^{\circ}\text{C}$
Output Power	1850 VA, maximum, per phase
AC Noise Level	>60 dB RMS below full output (sine wave, 40 to 500 Hz).
Voltage Program and Measurement Accuracy	$\pm 0.1\%$ of range. Above 1 kHz, add 0.2%/kHz. Add $\pm 0.1\%$ of full scale for "AC PLUS DC" mode. Valid for 5 to 156 VRMS and 10 to 312 VRMS at 25°C (77°F), sense leads connected. Temperature coefficient less than 50 ppm/°C
Voltage Program resolution	0.1 V from Front Panel 0.01 V from remote programming
Voltage Stability	$\pm 0.1\%$ of full scale over 24 hours at constant line, load and temperature. (Measured at Remote Sense point)
Voltage Distortion	0.25% maximum, 40 to 100 Hz; 0.5% maximum to 500 Hz; and 1% maximum to 1 kHz plus 1%/kHz to 5 kHz (Full linear load or No load)
Load Regulation	$\pm 0.025\%$ of full scale voltage for a full resistive load to no load; above 1 kHz, add $\pm 0.015\%/kHz$
Line Regulation	$\pm 0.025\%$ of full scale for a $\pm 10\%$ input line change.
Phase Accuracy Resistive Load	$\pm 1^{\circ}$, 40 to 1 kHz plus $\pm 1^{\circ}/kHz$ above 1 kHz
Phase Program Resolution	$\pm 0.1^{\circ}$
External Amplitude Mod	0 to 5 VRMS provides 0 to $\square 20\%$ ($\pm 2\%$ of full scale output)
External Direct Input	0 to 5 VRMS (DC to 5 kHz) for 0 to full-scale output ($\pm 2\%$ of full scale output to 3 kHz. $\pm 2\%$ from 3 kHz to 5 kHz). Limited to $\pm 7.25 V_{\text{peak}}$
DFI output	Contact closure to indicate: Loss of AC line and indication of various Status that can be remotely programmed.

Function	Specification
External Gain Control, RPV	0 to +7.07 VDC for 0 to programmed output. 0 to full-scale output for CSW. ($\pm 2\%$ of full scale output)
External Input Impedance	40K for each of the three inputs.
XLOAD	<p>The CSW5550 is guaranteed to be stable for power factors from 0 leading to 0 lagging. The most difficult load for most amplifiers is driving large capacitive loads (10-10,000μF). Though stable with its normal loop compensation, the CSW can provide additional phase/gain margin with these unusual loads by selecting XLOAD On. This significantly improves the transient response of the amplifier.</p> <p>X-Load should only be used for reactive loads, and with programmed frequencies of less than 1000 Hz.</p>

Current derates at higher voltage settings along constant power curve. See Figure 2-1 and [Figure 2-2](#) for voltage current ratings per phase.

Maximum current for which specifications apply is de-rated linearly from 50% of voltage to 10% of specified current at 5% of voltage range as shown. Higher currents are available but not all specification will apply under these conditions.

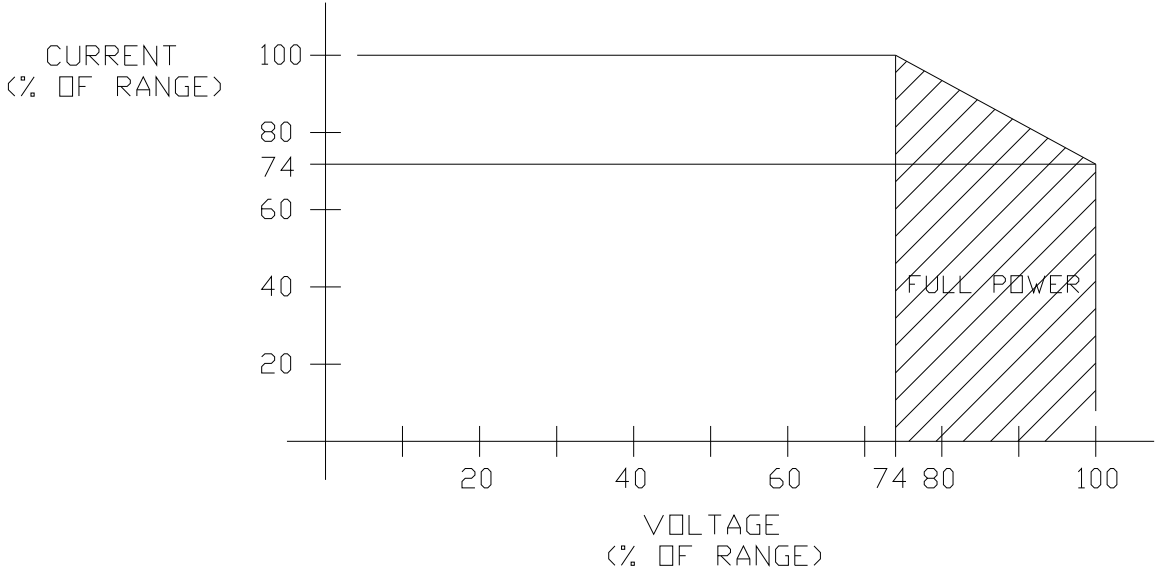

Figure 2-1: CSW5550 - Voltage Current rating

Output Parameter	CSW5550 (multiply current and power by the number of power sources in multi-source power systems)	
Current Limit		
Range	Programmable 0 to 100% of range for all ranges	
Resolution	0.01 Arms	
Accuracy	± 1% of Range. Add ±1.5%/kHz above 500 Hz	
Frequency Range: (Without Cloc/ Lock option enabled)	16.00 - 81.91 Hz (0.01 Hz resolution) 81.0 – 819.1 Hz (0.1 Hz resolution) 820 – 5000 Hz (1 Hz resolution)	
Frequency Accuracy:	± 0.01% of programmed value	
DC Offset Voltage:	Less than 20 mV with linear load in AC Output Mode.	
AC Noise Level:	>60 dB RMS below full output (sine wave, 40 to 500 Hz)	
Output Impedance (CSW5550 only)	1-phase mode, 312V range- meets requirements of IEC-1000-3-2, Annex A, Supply Source. Valid for equipment classes A, B, C, and D	
Peak Repetitive Current	52 amps for 156 V range	26 amps for 312 V range
Crest Factor:	3.25 (peak output current to RMS output current)	

2.1.3 Measurements

(All specifications are at 25°C unless noted otherwise)

Parameter	Accuracy (±)	Resolution
Frequency	2 counts 0 to 45°C	0.01: 16 to 81.91 Hz 0.1: 82.0 to 819.0 Hz 1: 820 to 5000 Hz
RMS Voltage	±0.1% of range from 5 to 156 or 10 to 312 volts. Above 1kHz add 0.2%/kHz	0.01 Volt
RMS Current	±1% of range add ±1.5%/kHz above 500 Hz Ranges: 0.5 to 16A: 156V range 0.5 to 8A: 312V range Multiply by 3 for 1-phase mode	0.001 Amp
Peak Current	±5% of range, 40 to 500 Hz; add ±1%/kHz 500 to 5 kHz Ranges: 0 to 56A; 156V range 0 to 28A; 312V range Multiply by 3 for 1-phase mode	0.01 Amp
VA Power	±2.5% of range, DC or 40 to 500. Add ±1%/kHz above 500 Hz. Ranges: 1.8kVA; 3-phase mode 5.6kVA; 1-phase mode	1 VA
Real Power	±2.5% of range, DC or 40 to 500. Add ±1%/kHz above 500 Hz. Ranges: 1.8kW; 3-phase mode 5.6kW; 1-phase mode	1 W
Power Factor (>0.2kVA)	±5% of range at full power, 40 to 500 Hz. Add ±1%/kHz above 500 Hz	0.01
Temperature Coefficient	<±50 ppm for all functions above↑	
Frequency	2 counts (0 to 45°C)	0.01: 16 to 81.91 Hz 0.1: 82.0 to 819.0 Hz 1: 820 to 5000 Hz
Phase	±2°, 40 to 500 Hz, add ±2°/kHz above 500 Hz. (0 to 45°C)	±1° for outputs above 20 VRMS
Current and Power Accuracy specifications are percent of Range. The Ranges are listed below . Measurement bandwidth is limited to 16 KHz.		

Function	Voltage Range	Mode	MODEL (Current and Power Range per Output Phase)							
			CSW5550	CSW11100	CSW16650	CSW22200	CSW27750	CSW33300	CSW38850	CSW44400
Current	156V	3Ø	16A	32A	48A	64A	80A	96A	112A	128A
Current	156V	1Ø	48A	96A	144A	192A	240A	288A	336A	384A
Current	312V	3Ø	8A	16A	24A	32A	40A	48A	56A	64A
Current	312V	1Ø	24A	48A	72A	96A	120A	144A	168A	192A
Power	156/312	3Ø	1850VA	3700VA	5550VA	7400VA	9250VA	11100VA	12950VA	14800VA
Power	156/312	1Ø	5550VA	11100VA	16650VA	22200VA	27750VA	33300VA	38850VA	44400VA

2.1.4 Harmonic Measurements (CSW series)

Parameter	Range	Accuracy (±)	Resolution
Frequency fundamental	16.00 - 1000 Hz	2 counts	0.01 Hz to 1 Hz
Frequency harmonics	32.00 Hz - 16 kHz	2° typ.	0.5°
Voltage	Fundamental	0.25V	0.01V
	Harmonic 2 - 50	0.25V + 0.1% + 0.1%/kHz	0.01V
Current	Fundamental	!% of Range	0.01A
	Harmonic 2 - 50	1% of Range + 0.1%/kHz	0.01A
Harmonics frequency range in three-phase mode is 32 Hz - 16 kHz. Measurement bandwidth is limited to 16 KHz.			

2.1.5 System Specification

Parameter	Specification
NV memory storage:	16 complete instrument setups and transient lists, 100 events per list.
Waveforms	Sine, square, clipped, user defined
Transients	Voltage: drop, step, sag, surge, sweep
	Frequency: step, sag, surge, sweep
	Voltage and Frequency: step, sweep
IEEE-488 Interface:	SH1, AH1, T6, L3, SR1, RL2, DC1, DT1 IEEE 488.2 and SCPI Response time is 10 ms (typical)
RS232C Interface:	Bi-directional serial interface 9 pin D-shell connector Handshake: CTS, RTS Data bits: 7, 8 Stop bits: 1,2 Baud rate: 9600, 19200, 38400 (Models without USB I/F) Baud rate: 9600, 19200, 38400, 57600, 115200, 230400, 460800 IEEE 488.2 and SCPI. Note: Disconnect any USB connection when using the RS232 interface.
USB Interface:	Standard USB 1.1 peripheral. Data transfer rate: 460,800 bps Syntax: IEEE 488.2 and SCPI. Note: Use of the USB port to control more than one power source from a single PC is not recommended, as communication may not be reliable. Use GPIB interface for multiple power source control.
LAN Interface:	Option –LAN. When the LAN interface is installed, the RS232 interface is disabled. RJ45 Connector, 10BaseT, 100BaseT or 1000BaseT, Data transfer rate: 460,800 bps Protocol: TCP/IP. Syntax: IEEE 488.2 and SCP Note: Disconnect any USB connection when using the LAN interface.
Current Limit Modes:	Two selectable modes of operation. Constant current and constant voltage with hold-off time and trip.

System Specification (continued)

Parameter	Specification
Front Panel Trigger, BNC connector	Output available at the front panel BNC connector that provides a negative going pulse for any programmed voltage or frequency change. The trigger can be reassigned as an output when running list transients.
Front Panel Phase A, B and C, BNC connectors	These three outputs are representative of the programmed output waveform, magnitude and frequency. 0 to 4.86 Vrms represents 0 to a full-scale output voltage. The output impedance is 100 ohms.
External Signal	Individual inputs for an external signal for each of the three phases. A 0 to 5.0 Vrms input provides a 0 to full-scale output voltage of the supplied waveform
External Gain Control (RPV)	Individual inputs for an external DC signal for each of the three phases. A 0 to ± 7.07 VDC signal provides a 0 to full-scale output voltage.
/INHIBIT	A logic Lo or contact closure input to inhibit the outputs
MOD	An input for an amplitude modulation. 0 to 5 Vrms provides 0 to $\geq 20\%$ modulation for each of the three output phases
Trigger Input	An input to trigger a function
External Synch	A TTL input to frequency synchronize the outputs. The Phase A output can be programmed relative to the external input.

2.1.6 Unit Protection

Parameter	Specification
Input Overcurrent:	Circuit breaker with current trip control.
Input Overvoltage:	Automatic trip of input circuit breaker.
Input Overvoltage Transients:	Surge protection to withstand EN50082-1 (IEC 801-4, 5) levels.
Output Overcurrent:	Adjustable level constant current mode with a maximum set point between 0% and 10% above programmed value.
Output Short Circuit:	Peak and rms current limit.
Overtemperature:	Automatic shutdown.

2.2 Mechanical

Parameter	Specification
Dimensions:	19" (483 mm) wide x 8.75" (222 mm) high x 23.5" (597 mm) deep chassis size which is available in a rack mount or stand-alone configuration.
Unit Weight:	126.5 lb. (57.2 kg)
Material:	Steel chassis and front panel, Aluminum top cover and rear panel.
Finish:	Light textured painted external surfaces. Front and rear panels semi-gloss polyurethane color no. 26440 (medium gray) Top, bottom and sides semi-gloss polyurethane color no. 26622 (light gray).
Cooling:	Fan cooled with air intake on the sides and exhaust to the rear.
Internal Construction:	Modular sub assemblies.
Rear Panel Connections:	(see section 3 for description of connections) Input terminal block with cover Output terminal block with cover Remote voltage sense terminal block with cover System interface (not for table top use, use only in rack enclosed systems) Clock and Lock (not for table top use, use only in rack enclosed systems) RS232, GPIB, USB, LAN (option)

2.3 Environmental

Parameter	Specification
Operating Temp:	0 to +45 °C (32°F to 113°F)
Storage Temp:	-40 to +70°C.
Altitude:	< 2000 m
Relative Humidity:	85% maximum at 25°C decreasing linearly to 50% at 40°C.
Installation/Over voltage Category:	II
Pollution Degree:	2
Indoor Use Only	
Vibration:	Designed to meet NSTA 1A transportation levels.
Shock:	Designed to meet NSTA 1A transportation levels.

2.4 Regulatory

Electromagnetic Emissions and Immunity:	Designed to meet EN50081-2 and EN50082-2 European Emissions and Immunity standards as required for the “CE” mark.
Acoustic Noise:	65 dBA maximum at 0% to 50% load, 75 dBA maximum greater than 50% load to 100% load. Measured at one meter.
Safety:	Designed EN61010-1 European safety standards as required for the “CE” mark.

2.5 Front Panel Controls

Controls:	
Shuttle knob:	Allows continuous change of all values including output calibration and range change.
Decimal keypad:	A conventional decimal keypad facilitates quick entry of numerical values such as voltage, current limit, etc. The large blue enter key will make the value you enter effective. Using the SET key allows the user to preset all parameter values and update them all at once by pressing the Enter key.
Up/down arrow keys:	A set of up and down arrow keys is used to move the cursor position in all menus. This allows quick selection of the desired function or parameter.
Function keys:	Measure key will display most measurement values. Program key will show all program parameters. Output on/off key for output relay control. Phase key will switch display to show program and measured values for each phase.
Displays:	
LCD graphics display:	A large high contrast LCD display with backlight provides easy to read guidance through all setup operations.
Status indicators:	Large and bright status indicators inform the user of important power source conditions. The Remote lamp informs the user that the unit is under remote control. The Overload lamp indicates that excessive current is being drawn at the output. The Over temperature lamp illuminates when internal heat sink temperatures are too high. The Hi Range indicator is lit any time the unit is switched to high output voltage range. The Output On/Off indicator is on when the power source output relays are closed.

2.6 Special Features, Options and Accessories

Option	Description
- 704	Mil Std 704D & E test firmware. Mil Std 704A, B, C, & F test software (refer to Avionics Software Manual P/N 4994-971 for details). Note: Requires use of CSWGui Windows application software provided on CD ROM CIC496.
- 787	Boeing 787 Test software (refer to Avionics Software Manual P/N 4994-971 for details). Note: Requires use of CSWGui Windows application software provided on CD ROM CIC496.
- 160	RTCA/DO-160D test firmware RTCA/DO-160E test software (refer to Avionics Software Manual P/N 4994-971 for details).. Note: Requires use of CSWGui Windows application software provided on CD ROM CIC496.
- 411	IEC 1000-4-11 test firmware
- 413	IEC 1000-4-13 test hardware and firmware
-ABD	Airbus ABD0100.1.8 Test software (refer to Avionics Software Manual P/N 4994-971 for details).. Note: Requires use of CSWGui Windows application software provided on CD ROM CIC496.
-AMD	Airbus AMD24C Test software (refer to Avionics Software Manual P/N 4994-971 for details).. Note: Requires use of CSWGui Windows application software provided on CD ROM CIC496.
-LAN	Adds Ethernet interface (RJ45 connector) for local area network connection. (Available on P/N 7000-485 and 7000-486 models only).
-LF	Limits maximum output frequency to 500 Hz.
- RMS	Rack mounting kit with slides. Removable rack ears/handles standard.
-LK	Clock/ Lock Option. With this option enabled the programmed frequency resolution is 1 Hz for all programmed values of frequency. If the upper frequency limit is 819 Hz or less the standard program resolution applies.

2.7 Supplemental Specifications

Supplemental specifications are not warranted and generally reflect typical performance characteristics. These characteristics have been checked on a type test basis only and are not verified on each unit shipped. They are provided for reference only.

2.7.1 Output

Output Parameter	
Voltage:	
Slew rate:	> TBD V/micro sec
Stability:	0.25 % over 24 hour period at constant line, load and temperature.
Settling time:	< 0.5 msec
Frequency:	
Temperature coefficient:	± 5 ppm per degree C
Stability:	± 15 ppm per year

3. Unpacking and Installation

3.1 Unpacking

Inspect the unit for any possible shipping damage immediately upon receipt. If damage is evident, notify the carrier. **DO NOT** return an instrument to the factory without prior approval. Do not destroy the packing container until the unit has been inspected for damage in shipment.



WARNING: This power source weighs 126.5 lb (57.2kg). Obtain adequate help when moving or mounting the unit.

3.2 Power Requirements

The CSW5550 Power Source has been designed to operate from a 3-phase, 3-wire, 187 to 264 V_{L-L}, AC line or a 3-phase, 4-wire, 342 to 457 V_{L-L}, AC line (option -400).



CAUTION: Do not connect 400V into the 187-256V unit, the result could be a severely damaged unit.

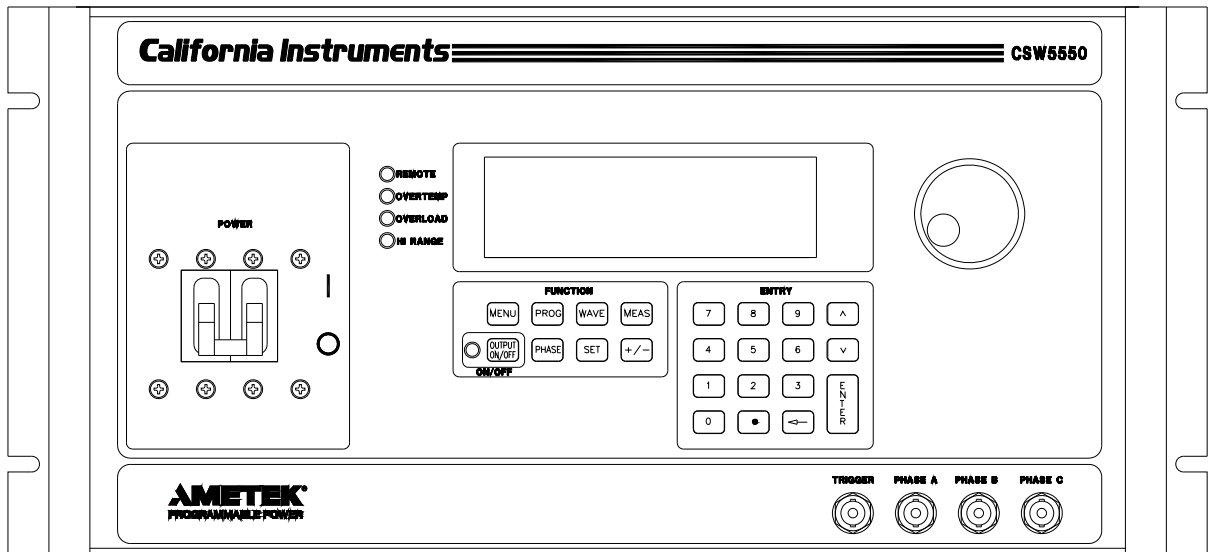

Figure 3-1:CSW5550

3.3 Mechanical Installation

The CSW series power sources are completely self-contained power sources. They may be used free standing on a bench top or rack mounted using the rack mount/handle kit. The units are fan cooled, drawing air in from the sides and exhausting at the rear. The sides of each unit must be kept clear of obstruction and a 6" clearance must be maintained to the rear. Special consideration of overall air flow characteristics and the resultant internal heat rise must be allowed for with systems installed inside enclosed cabinets to avoid self heating and over temperature problems.

Refer to Paragraph 2.2 for information on outline and mounting dimensions of the unit. Refer to Figure 3-3, Paragraph 3.6 and sub-paragraphs for rear panel connector information.

TYPE	MANUFACTURER	PART NUMBER
Mounting Kit (for slides)	Jonathan	BK-3
Slides	Accuride	C-3307-16D

Recommended Mounting Slide

3.4 Input Wiring – TB1

The input terminal block, TB1, is located at the rear of the unit. Ground (earth) wire must be connected to the chassis of the AC power system. The mains source must have a current rating equal to or greater than the input circuit breaker and the input wiring must be sized to satisfy the applicable electrical codes. The input terminal block cover and strain relief must be installed in table top applications to maintain protection against hazardous voltages.



CAUTION: *Capacitors in the power source may hold a hazardous electrical charge even if the power source has been disconnected from the mains supply. Allow capacitors to discharge to a safe voltage before touching exposed pins of mains supply connectors.*

3.4.1 187 to 264 VRMS L–L 3-Phase Operation (3-Wire USA)

Connect the input wires to the phase A, B, and C input terminal block terminals (no Neutral is required). **Ensure that the chassis safety ground is also connected.** Use cables with ratings equal to or greater than the current rating listed on the unit or in Paragraph 3.5.1. Any phase sequence of wiring can be used.

3.4.2 342 to 457 VRMS L–L 3-Phase Operation (4-Wire INTL)

It is essential that the Neutral connection is present when using the unit. Only units that are factory set at this voltage will operate at this voltage.

Connect the input wires to phases A, B, C and Neutral of the input terminal block. **Ensure that the chassis safety ground is also connected.** Use cables with ratings equal to or greater than the current rating listed on the unit or in paragraph 2.1.1.

3.4.3 Single-Phase Input Connections

The CSW system is designed for three-phase input power operation, either 3-wire (USA) or 4-wire (EUR) plus a chassis safety ground. However, if only single-phase input power is available, the configurations listed in paragraph 2.1.1 are possible.

3.5 Output Power Connections – TB2

The output terminal block, TB2, is located at the rear of the unit. Refer to Figure 3-3 for an illustration of the power source rear panel and all terminal strips and connectors. The external sense inputs allow the power system output voltages to be monitored directly at the load and must be connected either at TB2 or the load when the sense is programmed for external. The external sense input does not have to be connected when Internal Sense is programmed. The external sense wires are to be connected to TB3 on the rear panel and should be run as a twisted pair for short lengths. Sense leads over three (3) feet long should be run as a twisted shielded pair. Refer to Figure 3-4 for all connections. Included in the power source ship-kit is a safety cover. This cover is used to cover the AC Line input, TB1, the Power Output terminal block, TB2, and the External Sense terminal block, TB3. Strain reliefs are included with the safety cover.

Note: The output of the power source is isolated from the input line and floating from chassis ground. The Output Neutral must not float more than 20 volts or an error will be reported and the output will shut down.

3.5.1 Wire Gauge Selection

The following guidelines assist in determining the optimum cable specification for your power applications. These guidelines are equally applicable to both DC and low frequency AC (up to 450 Hz) power cabling. The same engineering rules apply whether going into or out of an electrical device. Thus, this guide applies equally to the input cable and output cable for this California Instrument power source and application loads.

Power cables must be able to safely carry maximum load current without overheating or causing insulation destruction. It is important to everyday performance to minimize IR (voltage drop) loss within the cable. These losses have a direct effect on the quality of power delivered to and from instruments and corresponding loads.

When specifying wire gauge, the operating temperature needs to be considered. Wire gauge current capability and insulation performance drops with the increased temperature developed within a cable bundle and with increased environmental temperature. Thus, short cables with generously derated gauge and insulation properties are recommended for power source applications.

Avoid using published commercial utility wiring codes. These codes are designed for the internal wiring of homes and buildings and accommodate the safety factors of wiring loss, heat, breakdown insulation, aging, etc. However, these codes consider that up to 5% voltage drop is acceptable.

Such a loss directly detracts from the quality performance specifications of this power source.

Frequently, these codes do not consider bundles of wire within a cable arrangement.

In high performance applications, as in motor start-up and associated inrush/ transient currents, additional consideration is required. The cable wire gauge must consider peak voltages and currents, which may be up to ten times the average values. An underrated wire gauge adds losses, which alter the inrush characteristics of the application and thus the expected performance. The following table identifies popular ratings for DC and AC power source cable wire gauges.

<u>COLUMN 1:</u> SIZE (AWG)	<u>COLUMN 2:</u> AMPERES (MAXIMUM)	<u>COLUMN 3:</u> OHMS/100 FEET (ONE WAY)	<u>COLUMN 4:</u> IR DROP/100 FEET (COL. 2 X COL. 3)
14	15	0.257	3.85
12	20	0.162	3.24
10	30	0.102	3.06
8	40	0.064	2.56
6	55	0.043	2.36
4	70	0.025	1.75
2	95	0.015	1.42
1/0	125	0.010	1.25
3/0	165	0.006	1.04

Recommended Wire Gauge Selection Guide

The output power cables must be large enough to prevent a total voltage drop exceeding 1% of the rated output voltage between the power source and the load. Table 3-1 shows the AWG size of the cables that may be used. Cable lengths must not exceed twenty-five (25) feet. For lengths greater than 25 feet, calculate the voltage drop from the following formula:

$$2 \times \text{DISTANCE} \times \text{CABLE RESISTANCE PER FT.} \times \text{CURRENT} = \text{VOLT DROP}$$

LOAD CURRENT	WIRE GAGE
22 AMPS	10 AWG
37 AMPS	8 AWG
74 AMPS	4 AWG
111 AMPS	2 AWG

Table 3-1: Wire Sizes

3.6 Connectors - Rear Panel

A number of connectors are located on the rear panel of the power source. The connectors are identified by J numbers. The terminal strips are identified by TB numbers.

3.6.1 System Interface, Clock and Lock Connectors, J33 and J34

J33 and J34 are the Clock and Lock connectors. These connectors are only available with the LK option. The LK option is used to synchronize and control the phase shift between the Phase A output of the Master power source and the Phase A output of additional auxiliary power sources. The frequency of the auxiliary power sources is determined by the frequency of the master source. Refer to Figure 3-6 for the Clock and Lock connections to three power sources.

The System Interface connectors, J28A and J28B, are used to connect the Auxiliary power sources to the Master power source in multiple source systems. The power that is to be the Master source will have the System Interface cable plugged into its connector labeled "To Auxiliary", J28B. The other end of the System Interface cable will plug into J28A, labeled "To Master", of the first Auxiliary power source. Additional Auxiliary power sources will be chained together with additional System Interface cables. Refer to Figure 3-4 for the System Interconnect.

3.6.2 External Input/ Output Signal Connector

The External Input/ Output Connector is J32 on the rear panel. Table 3-2 shows the function for each pin of this connector.

J32	Description
1	External Signal A: The input for an external signal or RPV for Phase A referenced to pin 10
2	External Signal C: The input for an external signal or RPV for Phase C referenced to pin 10
3	MOD A: The input for an amplitude modulation for Phase A referenced to pin 12
4	MOD C: The input for an amplitude modulation for Phase C referenced to pin 12
5	SYNC-HI: The Hi input for the TTL External Sync input.
6	ISOCOM: The common for the RTIN and /INHIBIT functions
7	/INHIBIT: A logic Lo or contact input to inhibit the outputs referenced to pin 6
8	DFI: Pins 8 and 15 are the two pins for the isolated DFI function
9	External Signal B: The input for an external signal or RPV for Phase B referenced to pin 10
10	External Signal Common: The common for all external signal or RPV inputs
11	MOD B: The input for an amplitude modulation for Phase B referenced to pin 12
12	MOD-COM: The common for all amplitude modulation inputs
13	SYNC-LO: The Lo input for the TTL External Sync input
14	RTIN: An input to trigger a function, referenced to pin 6
15	DFI: Pins 8 and 15 are the two pins for the isolated DFI function

Table 3-2: System Interface Connector (J32)

3.6.2.1 /Inhibit (Remote Inhibit)

The /Inhibit input J32 pin 7 can be used to open and close the output relay of the power source. This input overrides the state of the output relay programmed from the front panel or the bus. It may be used for safety interlock purposes.

The default level for remote inhibit is a logic low or contact closure between pin J32-7 and pin J23-6 (ISOCAN). This will cause the output voltage to be programmed to 0.0 volts and the output relays to open. Alternatively, the level can be reversed using the “output:ri:level high” command over the bus.

The mode of operation of the remote inhibit can be changed using the Output mode bus command. This command selects the mode of operation of the Remote Inhibit protection. The following modes can be selected:

LATCHing	A TTL low at the RI input latches the output in the protection shutdown state, which can only be cleared by OUTPut:PROTEction:CLEAr.
LIVE	The output state follows the state of the RI input. A TTL low at the RI input turns the output off; a TTL high turns the output on.
OFF	The instrument ignores the RI input.

The RI output state is saved at power down. The factory default state is LIVE.

For details on programming the remote inhibit function, refer to the CSW programming manual

3.6.2.2 External Signal Inputs

The External Signal Inputs are for either a DC or Direct waveform inputs. The DC input is programmed by enabling the RPV function. This function is also called the External Gain Control. A 0 to 7.07 volt DC input will adjust the output voltage from 0 to a full-scale output.

3.6.2.3 Remote Sense Connector TB3

It is important that the remote sense connections are hooked up at the load for the programmed voltage to be correct at a load with high load currents. For single-phase systems, connect Phase A to phase A and neutral to neutral. For three-phase system configurations, connect all three phase and neutral.

If the sense lines are not connected the power source has internal resistors that will connect the sense lines to the Master power source output terminals.

NOTE: Do not reverse or swap sense connection phasing or damage to the unit may result.

For systems consisting of multiple CSW5550 chassis, the end user has to connect the external sense inputs of the Master power source for the correct External sense function. The Auxiliary power sources will have no control of the output voltage. Refer to Figure 3-3 for an illustration of the power source rear panel and the Remote Sense terminal strip. Note that there are multiple Neutral terminals for TB3. The terminals are all connected in parallel in the power source. Only one terminal needs to be connected to the sense point.

3.6.3 RS232C Serial Interface Connector

Pin	Name	Direction
1	N/C	
2	TxD	Output
3	RxD	Input
4	N/C	
5	Common	Common
6	N/C	
7	CTS	Input
8	RTS	Output
9	N/C	

Table 3-3: RS232 Connector pin out

The CSW series power sources use a regular straight-through DB9 male to DB9 female serial cable for the RS232 interface.

3.6.4 USB Interface

A standard USB Series B device connector is located on the rear panel for remote control. A standard USB cable between the AC Source and a PC or USB Hub may be used.

Note: Use of the USB port to control more than one power source from a single PC is not recommended, as communication may not be reliable. Use GPIB interface for multiple power source control.



Figure 3-2: USB Connector pin orientation

Pin	Name	Description
1	VBUS	+5 VDC
2	D-	Data -
3	D+	Data +
4	GND	Ground

Table 3-4: USB Connector pin out.

3.6.5 LAN Interface – RJ45

An optional RJ45 Ethernet 10BaseT connector is located on the rear panel for remote control. A standard RJ45 UTP patch cord between the AC Source and a network Hub may be used to connect the AC source to a LAN. For direct connection to a PC LAN card, a crossover RJ45 cable is required. Consult your network administrator for directions on connecting the AC source to any corporate LAN.

If the –LAN Ethernet interface option is present, the MAC Address (Media Access Control) of the Ethernet port is printed on the serial tag of the power source. The serial tag is located on the rear panel of the unit.

For information on how to set up a network connection or a direct PC connection using the LAN interface, refer to the CSW Series Programming Manual P/N M162084-03 distributed in Adobe PDF format on CD ROM CIC496.

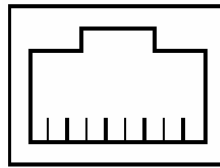

8 7 6 5 4 3 2 1

LAN

Pin	Ethernet TPE 10BaseT/100BaseT/1000BaseT	EIA/TIA 568A	EIA/TIA 568B Crossover
1	Transmit/Receive Data 0 +	White with green stripe	White with orange stripe
2	Transmit/Receive Data 0 -	Green with white stripe or solid green	Orange with white stripe or solid orange
3	Transmit/Receive Data 1 +	White with orange stripe	White with green stripe
4	Transmit/Receive Data 2 +	Blue with white stripe or solid blue	Blue with white stripe or solid blue
5	Transmit/Receive Data 2 -	White with blue stripe	White with blue stripe
6	Transmit/Receive Data 1 -	Orange with white stripe or solid orange	Green with white stripe or solid
7	Transmit/Receive Data 3 +	White with brown stripe or solid brown	White with brown stripe or solid brown
8	Transmit/Receive Data 3 -	Brown with white stripe or solid brown.	Brown with white stripe or solid brown

Table 3-5: RJ45 LAN Connector pin out.

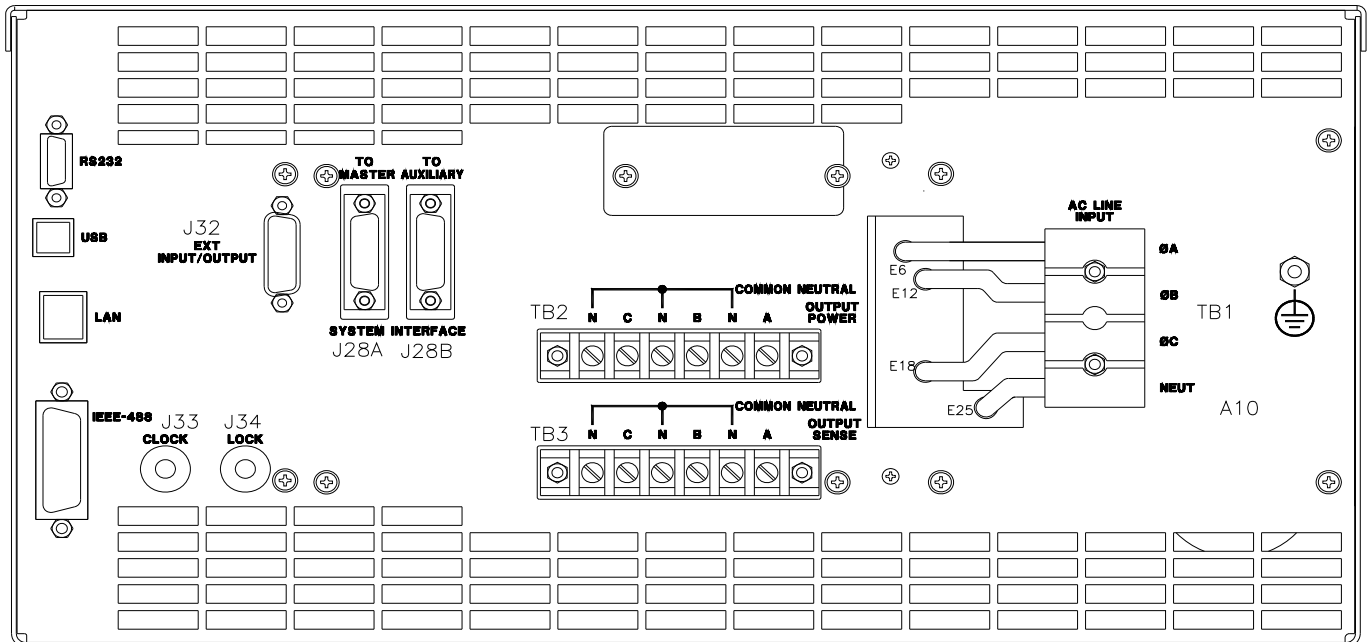

Figure 3-3: Rear Panel View for the CSW5550

3.7 Single-Phase and Three Phase Multiple Box System Configurations

Three Phase System:

Refer to Figure 3-4 for the output power connections for a 3-phase power system. For connections to a single power source disregard the connections to the Auxiliary power sources shown in Figure 3-4.

All multi-source systems must be interconnected using the system Interface cable. All of the respective outputs from the power sources must be connected at an external terminal block as shown in Figure 3-4. The connections to the Output Sense terminal block of the Master power sources should be connected to the point where the voltage is to be regulated. If the sense lines are not connected the programmed output voltage will be regulated and the output of the Master Power source.

For all multi-source power systems only the Master power source can control and report the measured system output.

Single Phase System:

Refer to Figure 3-4. If the Single Phase mode is programmed the Phase B and C output from all power sources must be connected to Phase A. The Master power source will still monitor the total output current from all of the power sources for each phase.

The units must all be connected with the system interface cable.

NOTE: The three Output Neutral connections from each source should be tied together. The Output Neutrals are connected internally but in the 1-phase mode because of the increased current they must be also connected external to the power source.

See Table 3-1 for cable sizing.

NOTE

After the power source system has been configured for the 1-phase mode of operation the Phase B and C outputs must be reconfigured as shown in Figure 3-7 for the 3-phase mode.

When the multi-source system is powered up the order of powering the Auxiliary power sources and the Master power source is not important. After the system is powered up if an Auxiliary power source is powered down there will be an error message displayed on the Master source, "Auxiliary Down". If power is reapplied to the Auxiliary power source the message will disappear and normal the operation can continue. If the System Interface cable is removed from the Auxiliary power source while the source is powered down the error message will disappear but the Master power source will not have the correct configuration. The Master must have the input circuit breaker toggled from Off to On for the correct configuration.

3.8 Output Voltage Ranges

The CSW Series power sources have two AC or DC voltage ranges (156Vrms and 312Vrms)
The maximum available load current is a function of the selected voltage range (high or low).

3.9 Functional Test



CAUTION: *Work carefully when performing these tests, hazardous voltages are present on the input and output during this test.*

Refer to Figure 3-4 and 3.5 for the test set up. Connect the 3-phase line input to the indicated rear panel terminal block. For the 380 to 415 VAC line input the Line Input Neutral must be connected. The Neutral connection is not used for the 208 to 240 VAC line input.

1. Connect an oscilloscope, voltmeter and/or distortion analyzer to the AC source output at the output terminal block (TB2).
2. With the AC mains verified as being off, apply the correct three phase AC power input voltage connections to the AC source input terminals barrier (TB1). Apply the AC mains power and turn on the main circuit breaker on the AC source front panel.
3. Verify the front panel LCD display lights up with the initial start up screen showing the unit ID and serial number. A self check routine screen with follow and finally the system will display the main "Menu 1" screen with the cursor highlighting the "Program" selection.
4. Press "ENTER" and the unit will display the Program selection screen. Set the following output parameters: output voltage = 115 volts, frequency = 60 Hz, voltage range = 156 volts, and current limit = 16.0 amps. Press "ENTER".
5. Enable the output by pressing the output "on/off" button below the front panel display screen. The green LED next to the button will light green when the output is on. The output should be a clean 115 volt AC sinewave having less than 1% distortion.
6. Apply full load to the output of the source and verify the output remains within 2% of the initial 115 volt value. The output should still be clean and the distortion should still be less than 1% at 60 Hz.
7. Program the power source to the Constant Current mode by first pressing the MENU key several times to select UTILITY 1. Then select VOLT/CURR CONTROL and then OL MODE. Program CC. Using the PROGRAM screen set the output current limit value to 8 amps. The system should go into current limit at the program value. Return the current

value to 16.0 amps and press the output on/off button to turn the output off. Disconnect the load.

8. Repeat steps 4 through 7 but set the output for the following: output voltage = 312 volts, output range = 230 volts, current limit = 8.0 amps. For step 7, the current limit value can be set to 4 amps.
9. Repeat steps 4 through 8 for each of the three phases.

In the unlikely event the power source does not pass the functional test, refer to the calibration procedure in Section 6 or call the Ametek customer service department for further assistance.

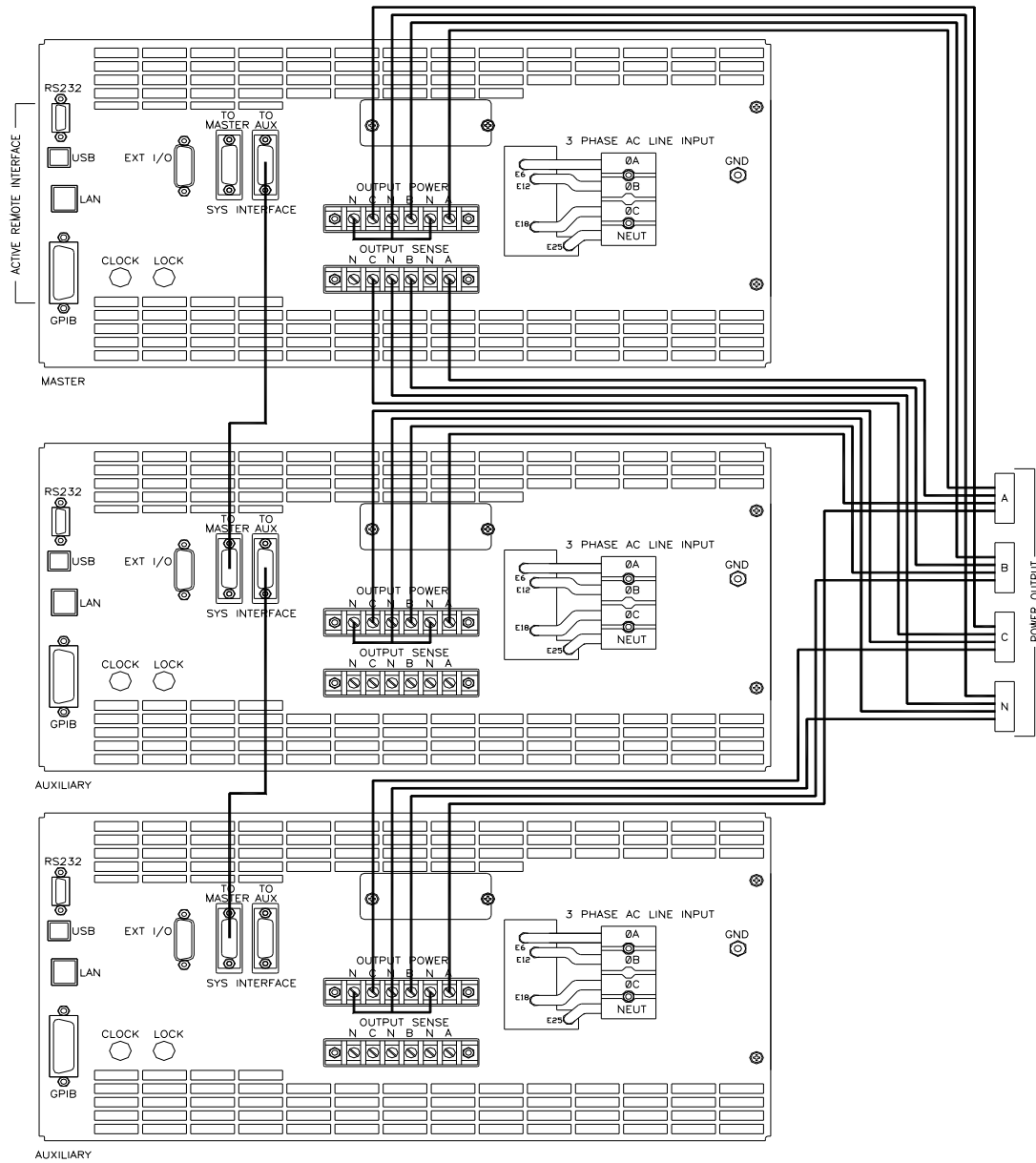

Figure 3-4: Output Power Connections for 1 Source and Multi-source Systems

NOTE: Connect all source Output Neutral terminals

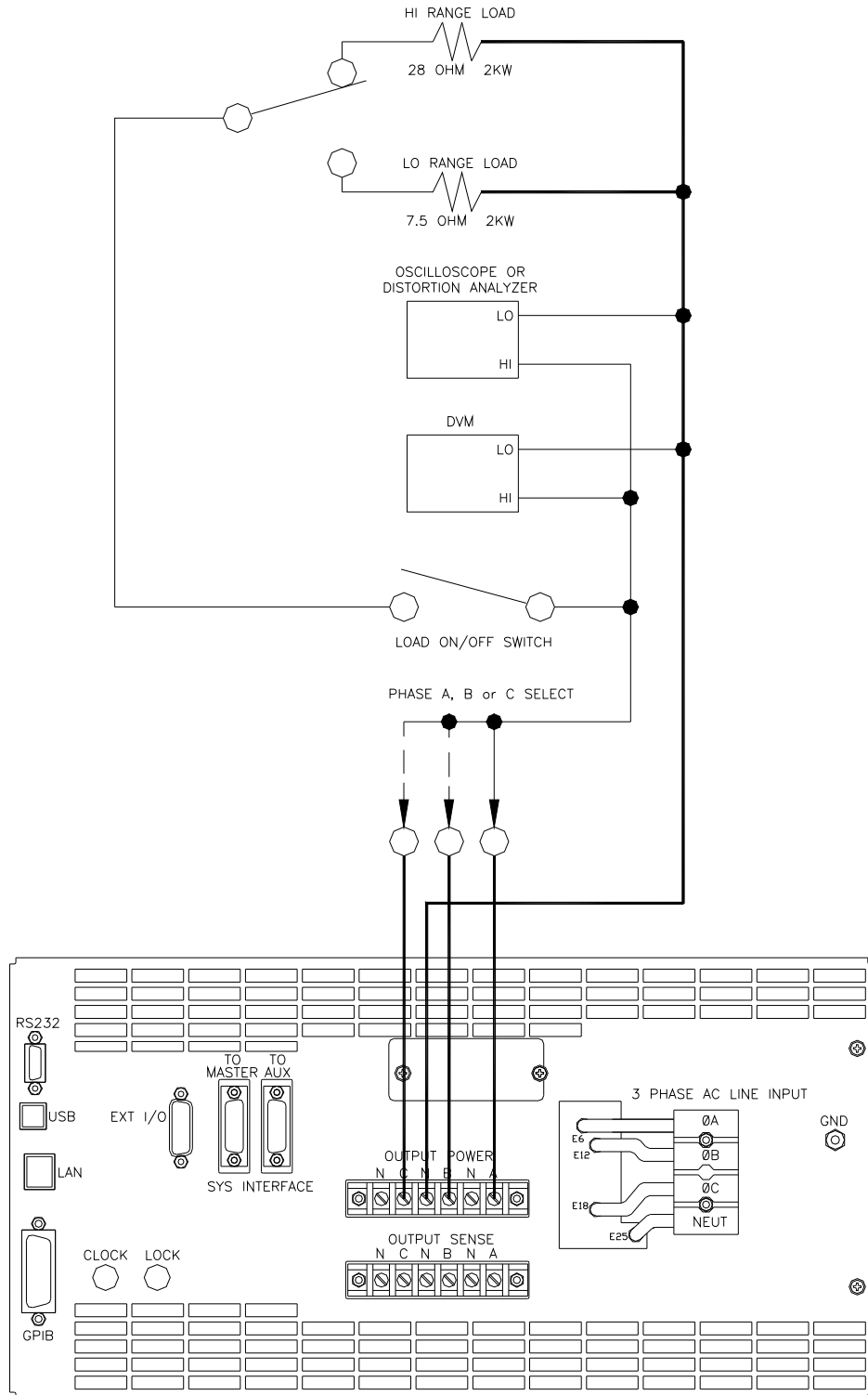

Figure 3-5: Functional Test Setup

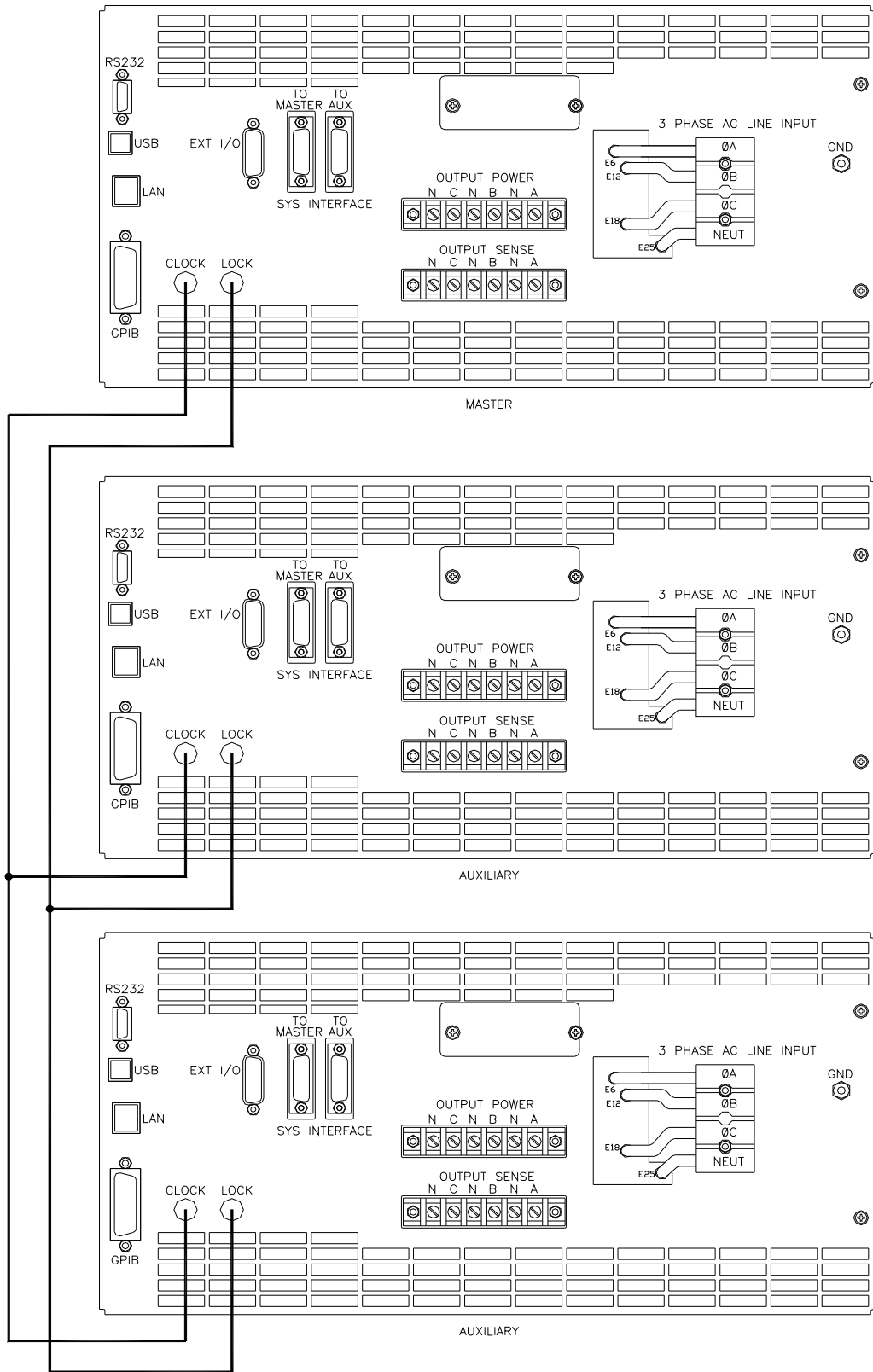

Figure 3-6: Three CSW Sources, 9-phases with Clock/Lock

4. Front Panel Operation

4.1 Tour of the Front Panel

Before operating the AC source using the front panel, it helps to understand the operation of the front panel controls. Specifically, the operation of the knob, keyboard and the menu layout are covered in the next few paragraphs.

4.1.1 Front Panel Controls and Indicators

The front panel can be divided in a small number of functional areas:

- Mains circuit breaker
- Status Indicator lights
- Shuttle knob
- LCD display
- FUNCTION keypad
- DATA ENTRY keypad

4.1.2 Mains Circuit Breaker

The circuit breaker located on the bottom left side of the front panel disconnects the AC source from the three phase Line input. It will automatically trip when the input current rating of the unit is exceeded due to some component failure. The contrasting black color and large size throw bar make it easy to locate in case of an emergency.

4.1.3 Status Indicator Lights

Four LED status indicators are located directly above the mains circuit breaker. These LED's correspond to the following conditions:

REMOTE	The REMOTE LED indicates that the unit is in remote control mode. If the IEEE-488 interface is used, this indicator will be lit whenever the REM line (REMOTE ENABLE) line is asserted by the IEEE controller. If the RS232C, USB or LAN interface is used, the REMOTE state can be enabled by the controller using the SYST:REM command. Any time the REMOTE LED is lit, the front panel of the i Series unit is disabled. There is no LOCAL button that allows the user to regain control of the front panel. This prevents accidental change of settings in ATE applications.
OVERLOAD	The OVERLOAD LED indicates an output overload condition. This condition can be controlled by setting the current limit value in the PROGRAM menu. Removing the load using the OUTPUT ON/OFF button will recover from an overload condition.
OVERTEMP	The OVERTEMP LED indicates an overheating problem inside the unit. This is an abnormal condition, which will cause the unit to shut off. Check the air openings to make sure they are not blocked.
HI RANGE	The HI RANGE LED is on when the high voltage output range has been selected.

4.1.4 The Shuttle Knob

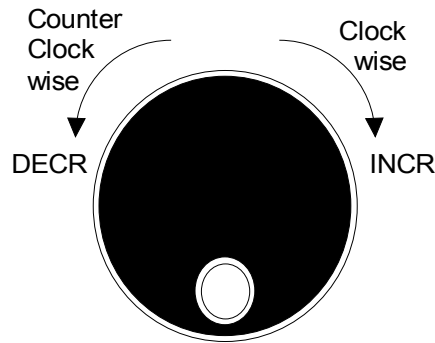

Figure 4-1: Shuttle Knob

The shuttle knob is located to the right of the LCD screen and is used to change setup parameters. Note that it cannot be used to move the cursor position between menu fields. Use the UP and DOWN arrow keys in the FUNCTION keypad for this.

The shuttle knob can operate in one of two distinct modes of operation:

MODE	DESCRIPTION
IMMEDIATE mode	Any time the ENTER key is pressed, the CSW Series returns to its normal mode of operation. In this mode, changes made with the shuttle knob or the data entry keypad will take immediate effect. The IMMEDIATE mode is useful for slewing output values such as voltage and frequency and observing the effect on the load.
SET mode	When the SET key located in the FUNCTION keypad is pressed, changes made with the shuttle to any output parameter will not take effect until the ENTER key is pressed. In this mode, any changes made to a setup menu will be blinking to indicate the pending change condition. This mode allows changes to be made to all output parameters and executing them all at once by pressing the ENTER key.

4.1.5 FUNCTION Keypad

The function keypad provides access to all menus and measurement screens. The following keys are located in the FUNCTION keypad:

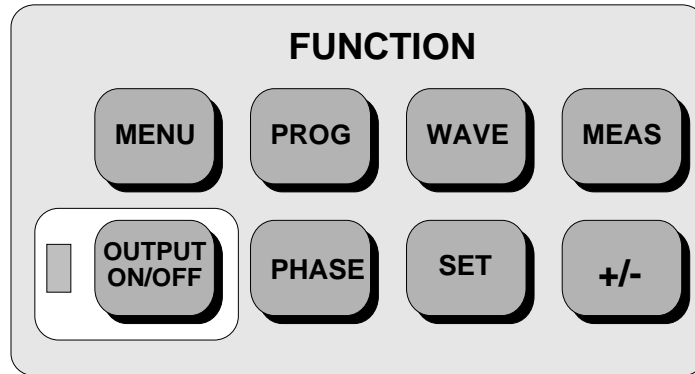

Figure 4-2: FUNCTION keypad

KEY	DESCRIPTION
MENU	The top level menu is accessed by pressing the MENU key. Three shortcut keys are used to provide direct access to the PROGRAM, WAVEFORM, and MEASUREMENT screens as these are among the most frequently used screens. Thus, instead of going through the main menu to reach the PROGRAM, WAVEFORM, and MEASUREMENT screens, they can be accessed directly by pressing the PROG, WAVE, and MEAS keys respectively. A map of the Main menus is provided on the next few pages. There are three top-level menus in the CSW Series.
PROG	The PROG key is a shortcut to access the PROGRAM menu directly. The PROGRAM menu is one of the most frequently used menus. Thus, instead of going through the main menu to reach the PROGRAM menu, it can be accessed directly by pressing the PROG key.
WAVE	The WAVE key is a shortcut to access the WAVEFORM screen directly. The WAVEFORM screen is used to select a user defined arbitrary waveform.
MEAS	The MEAS key is a shortcut to access the MEASUREMENT screen directly. The MEASUREMENT screen is one of the most frequently used screens. Thus, instead of going through the main menu to reach the MEASUREMENT screen, it can be accessed directly by pressing the MEAS key.

OUTPUT ON/OFF	The OUTPUT ON/OFF key toggles the output relay on or off. The state of the output relay is reflected by the green LED located directly to the left of the OUTPUT ON/OFF key. If the green LED is lit, the output relay is enabled (closed) and the programmed output voltage is present at the output terminals. If the green LED is off, the output relay is open and both the HIGH and LO terminal of the output terminal block are disconnected from the power source. In this mode, the output is floating. The ON/OFF button provides a convenient way to disconnect the load without having to remove any wires.
PHASE	The PHASE key is used to select the phase while operating in the 3-phase mode. Pressing the PHASE key will toggle phase A, B, C or ABC. Some screens may not support the ABC or show all phase information in which case this mode is skipped. In the 1-phase mode the PHASE will only select Phase A.
SET	The SET key is used to select the mode of operation of the shuttle. Refer to section 4.1.1 for details on its operation and the use of the SET key.
+/-	The +/- key can be used to toggle the sign for those parameters for which it is relevant. This is typically the output voltage when in DC mode of operation. For fields that have only two possible values such as the voltage range field, the +/- key can be used to toggle between these two values.

4.1.6 DECIMAL KEYPAD

The decimal keypad may be used to enter any numeric parameter required in any of the menu fields. Several fields accept input from either the keypad or the knob. Data entered from the keypad is normally accepted once the ENTER key is pressed unless the front panel mode is in the SET mode. The following keys are available on the decimal keypad:

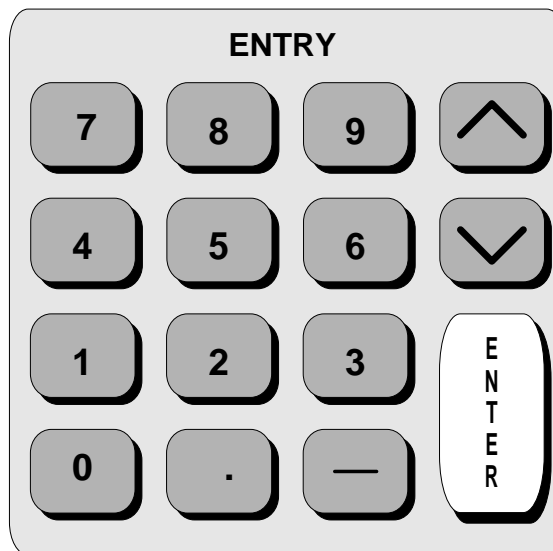

Figure 4-3: Entering value from decimal keypad

CURSOR UP

The UP key moves the cursor position upwards one position to the previous available cursor position. If the present cursor position is at the top of the right hand column, the cursor is moved to the bottom position of the left hand column. If the present cursor is at the top of the left hand column, the cursor is moved to the bottom of the right hand column. Figure 4-4 depicts the cursor movement through a two-column menu.

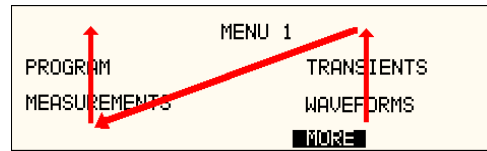

Figure 4-4: Cursor UP key movement

CURSOR DOWN

The DOWN key moves the cursor position downwards one position to the next available cursor position. If the present cursor position is at the bottom of the left hand column, the cursor is moved to the top position of the right hand column. If the present cursor is at the bottom of the right hand column, the cursor is moved to the top of the left hand column. Figure 4-5 depicts the cursor movement through a two column menu.

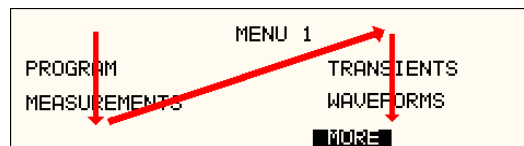

Figure 4-5: Cursor DOWN key movement

The decimal keypad can be used at any time in lieu of the shuttle knob to change output parameters. Direct data entry is often faster to effect large changes in values than using the shuttle knob. Note that pressing the ENTER key while in SET mode of operation will cause the AC source to revert back to IMMEDIATE mode. Thus, to change all parameters in SET mode, enter a value for each field and then proceed to the next field without pressing the ENTER key.

0 through 9

The numeric keys provide all decimal number for entry of parameters.

DECIMAL POINT

The decimal point key is used to enter fractional parts of values for fields that have a resolution less than 1. The amount of resolution for each menu field is normally visible on the LCD. If more digits are entered after the decimal point than can be accepted by a field, the value is automatically rounded to the available resolution when the ENTER key is pressed.

BACKSPACE

The BACKSPACE (←) key can be used to erase one digit at a time if you make a data entry error.

4.1.7 LCD Display

The LCD display of the CSW Series power source provides information on instrument settings and also guides the user through the various menus. To ease reading of the displayed information, most screens are widely spaced. A sample of the main menu 1 screen that appears when the source is powered up is shown in Figure 4-6. Due to the amount of space available on each screen, some menus have been split into parts. The MORE selection located at the bottom right hand side provides access to menu choices at the same level that did not fit on a single screen. Thus, to access MENU 2, the cursor should be placed on the 'MORE' selection followed by pressing the 'ENTER' key. Alternatively, the MENU key may be pressed to move to the MENU 2 screen.

The present cursor position is always shown with a inverse bar. The cursor is located on the 'MORE' selection in Figure 4-6. Pressing ENTER would cause MENU 2 to be displayed.

The cursor position can be moved by using the UP and DOWN keys located in the **DECIMAL** keypad.

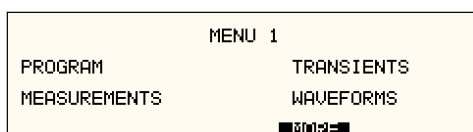

Figure 4-6: Main Menu 1 screen

4.2 Menu Structure

The next few pages show a map of the available menus in the i/CSW Series. There are three main level (level 1) menus from which all other menus can be reached. Frequently used (level 2) menus have a short cut key that provides direct access. Examples of such menus are Program, Measurements, and Waveform. In any case, there are never more than three levels of menus although some menu may be spread across more than one screen.

4.2.1 MAIN Menu

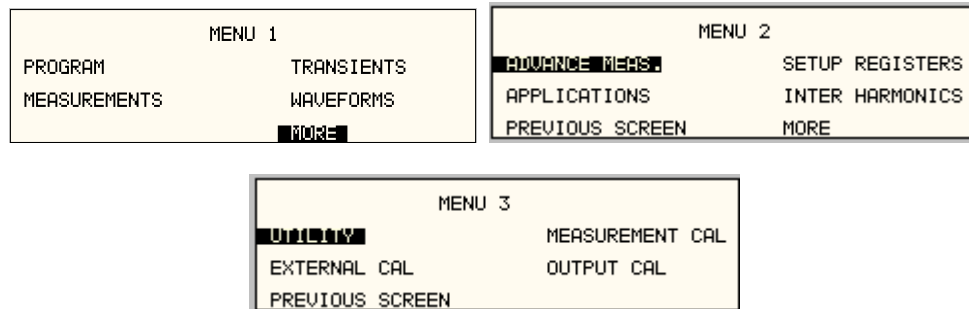

Figure 4-7: Menu 1 through 3

The top-level menu is split in three parts, MENU 1 through MENU 3 to allow spacing between menu entries. MENU 2 and 3 can be reached from MENU 1 by selecting the MORE entry or by pressing the MENU key repeatedly, which will toggle from MENU 1 to 2 to 3 and back to 1. The division of menu choices between the two screens is graphically illustrated in sections 4.2.2 and 4.2.3 by the boxes in level 1. Each box represents one screen. Subsequent screens can be reached using the MORE entry.

The following top-level menu choices can be accessed from the MENU key:

Entry	Description
MENU 1	
PROGRAM	The PROGRAM menu allows output parameters to be changed.
MEASUREMENTS	The MEASUREMENTS screens are not menus in that no user entries are required.
TRANSIENTS	The TRANSIENTS menu allows output transients to be programmed.
WAVEFORMS	The WAVEFORMS menu allows different waveforms to be selected from the waveform library.
MORE	The MORE selection causes the second part of the MENU screen to be displayed. (MENU 2)
MENU 2	
ADVANCED MEAS.	The ADVANCED MEAS. screens are for display only. No user entries are required.
APPLICATIONS	The APPLICATIONS menu provides access to the optional firmware application programs that may be installed in the CSW Series source.
SETUP REGISTERS	The SETUP REGISTERS menu allows complete instrument settings and transient list programs to be saved to nonvolatile memory.
INTER HARMONICS	The INTER HARMONICS screen allows the source to perform IEC61000-4-13 tests. These tests are for harmonics and inter-harmonics for low frequency immunity tests.
MORE	The MORE selection causes the third part of the MENU screen to be displayed. (MENU 3)
MENU 3	
UTILITY	The UTILITY menu provides access to less commonly used setup screens such as those for the GPIB and RS232C (also applies to USB and LAN) interface settings, initial startup values, etc.
EXTERNAL CAL	The EXTERNAL CAL menu allows for calibration of all external inputs. This includes the External Signal and RPV inputs.
MEASUREMENT CAL	The MEASUREMENT CAL menu allows for calibration of the AC source measurement system.
OUTPUT CAL	The OUTPUT CAL menu allows for calibration of the AC source output with the ALC in the OFF state.

Following the Menu overview pages is a detailed description of each menu and sub menu.

4.2.2 Overview of Menu 1

	level 1	level 2	level 3		
MENU 1	PROGRAM	PROGRAM1 VOLTAGE FREQ VOLT RANGE CURR LIMIT MORE			
		PROGRAM2 PHASE CLOCK MODE VOLT MODE DC OFFSET START \emptyset			
	MEASUREMENTS	MEASUREMENTS1 VOLTAGE CURRENT FREQ POWER MORE			
		MEASUREMENTS 2 VA POWER PEAK CURR POWER FACT CREST FACT PEAK CURR RESET			
MEASUREMENTS 3 VOLT THD CURR THD INST PK CURR PHASE					
HARMONICS/TRACE ANALYSIS FUNCTION VIEW DATA MODE SCALE TRIG MODE TRIG SOURCE TRIG PHASE TRIG DELAY START					
TRANSIENTS	VOLT SURGE/SAG VOLT SWEEP/STEP FREQ SWEEP/STEP VOLT/FREQ SWEEP/STEP START/VIEW SEQUENCE PREVIOUS SCREEN				START \emptyset
		START PAUSE REPEAT #0 CLEAR SEQ #1 #2 .. #98 #99 PREVIOUS SCREEN	DURATION END VOLT END FREQ END DELAY FUNCTION REPEAT EVENT# REPEAT SEQUENCE# PREVIOUS SCREEN	DURATION END FREQ END DELAY FUNCTION REPEAT EVENT# PREVIOUS SCREEN	END VOLT DUR SCALE DURATION END VOLT END DELAY FUNCTION REPEAT EVENT# PREVIOUS SCREEN
WAVEFORMS	CLIP LEVEL GROUP MODE SINE SQUARE CLIPPED USER WAVE USER WAVE				
MORE					

4.2.3 Overview of Menu 2 and 3

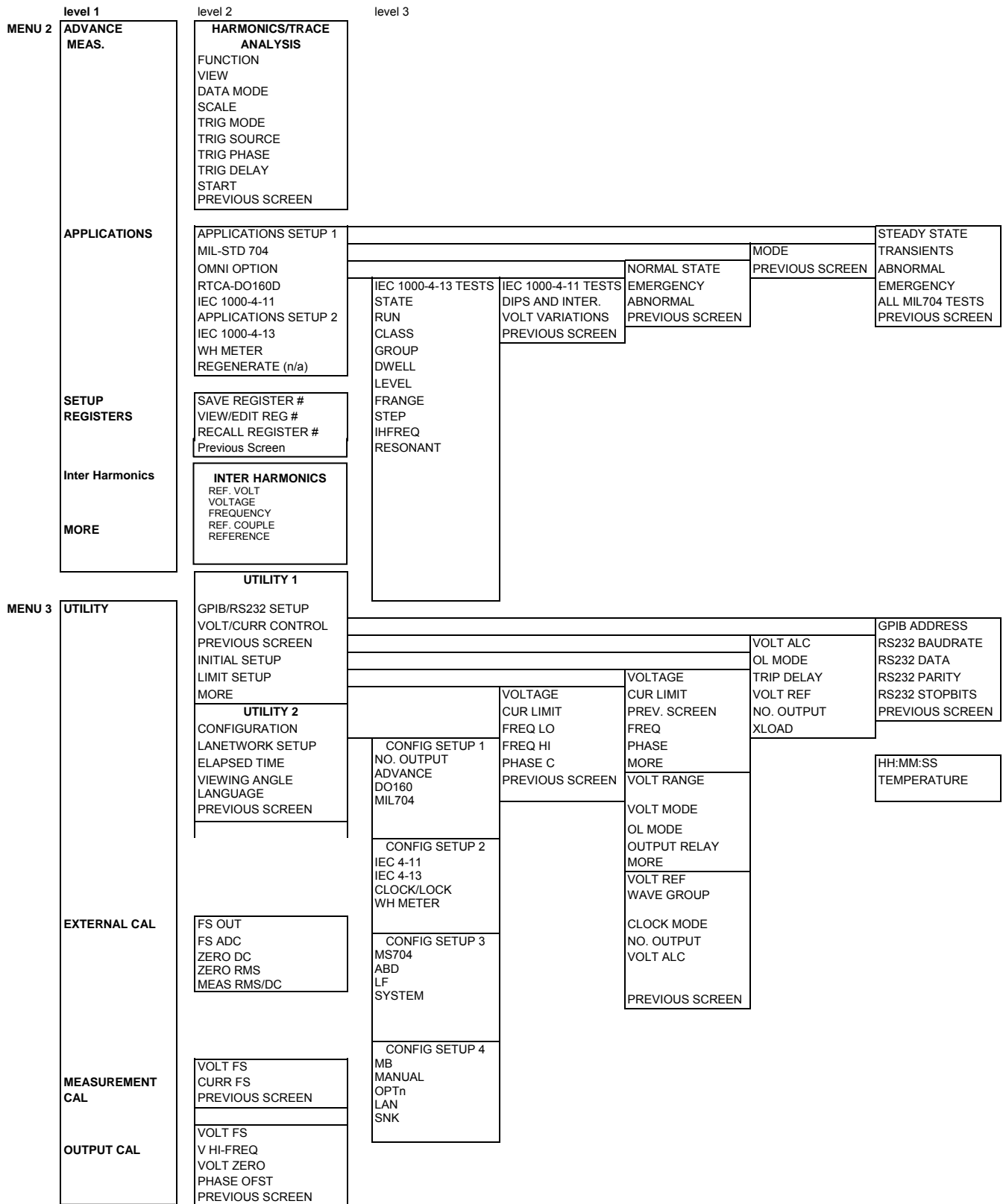

4.2.4 PROGRAM Menu

PROGRAM 1		ΦA
VOLTAGE =0.0V	VOLT RANG =156	
FREQ =60.00Hz	CURR LIMIT =16.00A	
PREVIOUS SCREEN	MORE	

PROGRAM 2	
PHASE =-178.9°	VOLT MODE =AC
CLOCK MODE= INT	DC OFFSET =0.0V
PREVIOUS SCREEN	START φ =90°

Figure 4-8: PROGRAM Menu

The PROGRAM menu is shown in Figure 4-8. It can be reached in one of two ways:

1. by selecting the PROGRAM entry in the MENU screen and pressing the ENTER key
2. by pressing the PROG key in the FUNCTION keypad

The PROGRAM menu is used to change output parameters. The most commonly used parameters are all located in PROGRAM 1. The PREVIOUS SCREEN entry, when selected, will return the user to the most recently selected menu. This is normally the MENU screen unless the PROGRAM menu was selected using the PROG key on the FUNCTION keypad. Less frequently used parameters are located in PROGRAM 2, which can be reached from the PROGRAM 1 screen using the MORE selection, or by pressing the PROGRAM key twice.

The following choices are available in the PROGRAM menus:

Entry	Description
PROGRAM 1	
VOLTAGE	Programs the output voltage in rms. when in AC mode or absolute voltage when in DC mode. In DC mode, negative values can be entered.
FREQ	Programs the output frequency when in AC mode. If the unit is in DC mode, the value for FREQ will be set to DC and cannot be changed until AC mode is selected. When in AC mode, the frequency can be changed from 16 Hz to 5000 Hz. Values entered that fall outside this range will generate a -200 RANGE ERROR and will not be accepted.
VOLT RANGE	Selects 156V or 312V range. The actual range values may be different depending on the configuration. The value of this field can only be changed with the shuttle or the +/- key. Note that the voltage range is coupled with the output relay state. If the output relay is closed (OUTPUT ON), the voltage range cannot be changed.
CURR LIMIT	Sets the current limit value for the current detection system. When the load current value exceeds the set current limit, a fault condition is generated. The actual response of the AC Source to a current limit fault is determined by the protection mode selected in the CONFIGURATION menu. (CC = Constant Current, CV = Constant Voltage).

PROGRAM 2

PHASE	Selects the phase angle between the external clock and the output of the AC source. If the clock source is internal, this parameter has no effect.
CLOCK MODE	Selects internal or external clock source. The CSW Series uses an quartz crystal time-base with an accuracy of 100 ppm. To improve output frequency stability and accuracy, an external clock generator may be used.
VOLT MODE	The CSW Series offers three output modes, AC, DC and AC+DC. The VOLT MODE field can be used to toggle between these three output modes. Both the Knob and the +/- key may be used to toggle through these three selections. In DC mode, no frequency selection is possible and all maximum current and power ratings are divided by two.
DC OFFSET	When the AC+DC mode is selected, the VOLTAGE field in the PROGRAM 1 screen is used to set the AC portion of the output voltage. The DC OFFSET field in the PROGRAM 2 screen can be used to set the DC offset level. Either the knob or the decimal keypad may be used to set the DC offset level.
START \emptyset	Selects the start phase angle for output changes made to either voltage or frequency. This allows changing the output at a specific phase angle. The output on key also uses this phase angle setting to program the output voltage up to the set level after the output relay is closed. The default value for this field is RANDOM.

4.2.5 MEASUREMENTS Screens

The CSW Series uses a DSP based data acquisition system to provide extensive information regarding the output of the Source. This data acquisition system digitizes the voltage and current waveforms and calculates several parameters from this digitized data. The result of these calculations is displayed in a series of measurement data screens. The actual digitized waveforms can also be displayed by selecting the Harmonics/Trace Analysis screen. A total of four measurement screens are used to display all this information.

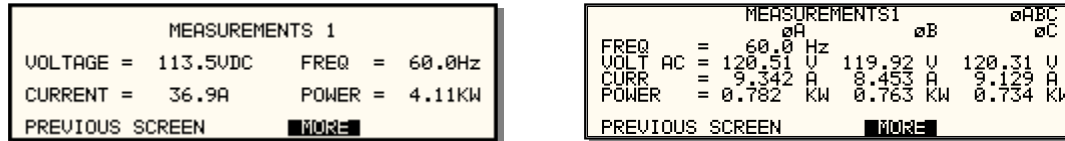

Figure 4-9: MEASUREMENTS Screen, single phase and three phase modes

The first three Measurement screens available on the CSW Series are not menus in that no changes can be made anywhere. Instead, these three screens provide load parameter readouts. The fourth measurement screen provides access to the advanced measurements and does offer several user accessible fields (CSW Series only). The measurement screens can be reached by successively pressing the MEAS key, which will toggle to all four available screens.

In three-phase configuration CSW Series, measurements are available for each phase individually. To select the desired phase, use the PHASE key to toggle through phase A, B, C, or ABC. The ABC mode displays the data for all three phases simultaneously.

The following parameters are available in the first three measurement screens:

Entry	Description
MEASUREMENT 1	
VOLTAGE	When in AC or AC+DC mode, this value is the true rms output voltage measured at the voltage sense lines. In DC only mode, the voltage is the DC voltage including polarity.
CURRENT	When in AC or AC+DC mode, this value is the true rms output current drawn by the load. In DC only mode, the current is the DC current including polarity.
FREQ	When in AC or AC+DC mode, the output frequency is measured at the sense lines. When in DC only mode, this value always reads "DC".
POWER	In both AC and DC mode, this value is the real rms. power consumed by the load.
MEASUREMENT 2	
VA POWER	In AC or AC+DC mode, this value is the apparent rms. power consumed by the load. In DC mode, this value is always the same as the POWER readout.
PEAK CURR	This readout reflects the peak current value detected at the output. To measure inrush current for a unit under test, open the output relay and reset the peak current value using the PEAK CURR RESET entry. Then program the output voltage and frequency and turn on the output relay. The peak current measurement will continuously track the maximum current value detected until reset.

POWER FACTOR	This readout shows the power factor of the load.
CREST FACTOR	This readout displays the ratio between peak current and rms current.

MEASUREMENT 3

VOLT THD	This readout displays the total voltage distortion for the selected phase. The distortion calculation is based on the H2 through H50 with the fundamental voltage (H1) in the denominator. Note that other common definitions of THD use the RMS value of the voltage as the denominator. This may result in different readings between instruments depending on the implementation chosen. The mode used by the power source is selectable over the bus.
CURR THD	This readout displays the total current distortion for the selected phase. The distortion calculation is based on the H2 through H50 with the fundamental current (H1) in the denominator. Note that other common definitions of THD use the RMS value of the current as the denominator. This may result in different readings between instruments depending on the implementation chosen. The mode used by the power source is selectable over the bus.
INST PK CURR	This readout reflects the instantaneous peak current value detected at the output. This value is updated continuously and does not require a reset operation like the PEAK CURR readout. The instantaneous peak current does not use a track and hold mechanism like the PEAK CURR measurement in the MEASUREMENT 2 screen. Instead, it tracks the peak current on a cycle by cycle basis. The INST PK CURR typically tracks the rms current and the crest factor.

Update Program Functions from Measurement Screen

The Shuttle can be used to update program parameters such as voltage, frequency or current from the measurement screen. This can be achieved with the following sequence:

1. Select the program 1 screen using the PROG key.
2. Use the up and down key to select the desired function to update. (Selects parameter that will be changed by the shuttle once in the MEAS1 screen)
3. Select the measurement 1 screen by pressing the MEAS key.

The pointer symbol (►) points to the programmed parameter (V,F or CL) that will be affected by turning the shuttle.

HARMONICS/TRACE ANALYSIS Screen

The fourth measurement screen is dedicated to the advanced measurements available on the CSW Series only. This screen is not available on the i Series. The Harmonics/Trace Analysis measurement screen is a true menu screen offering several user accessible fields. These fields are used to select the desired acquisition trigger and display mode. The actual data is displayed whenever the ENTER key is pressed while the cursor is on the VIEW or START field. The following fields are available on this menu:

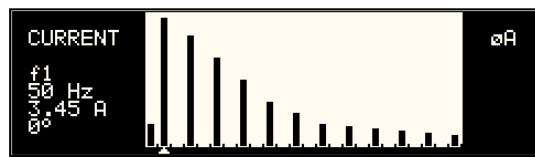

Figure 4-10: HARMONICS/TRACE ANALYSIS screen

Entry	Description
FUNCTION	Selects Voltage, Current or Both parameters for display.
VIEW	Available display modes are TABLE, BAR and TRACE. TABLE mode: displays the first 50 harmonics in a tabular text format.

VOLT HARMONIC MEASUREMENTS @A					
HR#	AMPL	PHASE	HR#	AMPL	PHASE
0	0.00	0.0	1	151.42	0.0
2	0.33	46.9	3	116.17	351.4
4	0.57	90.1	5	85.24	29.6
6	0.59	131.8	7	54.72	67.0
8	0.45	171.4	9	24.55	100.6

BAR mode: displays the first 50 harmonics in a graphical bar chart display.



TRACE mode: displays the selected Function in a time domain (waveform) graphical display.

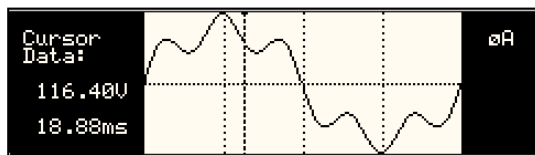

DATA MODE	Selects absolute or relative harmonics display for TABLE and BAR view modes. In relative mode, all harmonics are shown in a percentage of the fundamental which is normalized at 100 %. In absolute mode, the harmonic amplitudes are shown in absolute volts or amperes.
-----------	---

	<p>This mode does not apply to the TRACE view display mode and is ignored when this mode is selected.</p>
SCALE	<p>Sets the horizontal time axis for the TRACE view display mode. The fields range is 4 ms to 42 ms in single-phase mode or 12 ms to 128 ms in three phase mode.</p> <p>This parameter is ignored when the TABLE or BAR view display mode is selected.</p>
TRIG MODE	<p>This field sets the trigger mode for the acquisition. Available options are SINGLE (single shot acquisition) or CONT (continuous acquisition). In SINGLE shot mode, the acquisition is triggered once each time the START field is selected and the ENTER key is pressed. The selected trigger source is used to determine the trigger point. Once the acquisition has been triggered, the data are displayed and do not change until the next acquisition is triggered. This mode is most appropriate for single shot events such as start up currents.</p> <p>In the CONT mode, acquisitions occur repeatedly and the data is updated on screen after each trigger occurs. This provides a continuous update of the data and is most appropriate for repetitive signals.</p>
TRIG SOURCE	<p>The trigger source selects the event that will trigger a measurement acquisition. Available options for this field are IMM (immediate), PHASE A or SET VOLT. The IMM trigger source causes the acquisition to trigger immediately when the ENTER key is pressed on the START field. Essentially, this is an asynchronous trigger event. The acquisition will always be triggered in this mode and data is available immediately.</p> <p>The PHASE A source will cause the acquisition to trigger on the occurrence of a set phase angle for the voltage on phase A. The trigger source is always phase A when in this mode, regardless of the phase selection shown in the top right corner of the display. When the acquisition is started, the acquisition system waits for the specified phase angle to occur before triggering the acquisition. This mode allows exact positioning of the acquisition data window with respect to the voltage waveform.</p> <p>The SET VOLT mode causes the acquisition to trigger at the specified voltage. This mode also programs the selected phase or all three phases when the measurement is started from the START field. As such, this trigger source selection also programs the output voltage to the selected rms level.</p>
TRIG PHASE / SET VOLT	<p>This field changes purpose, depending on the trigger source selected immediately above it. If the trigger source equals IMM or PHASE A, this field can be used to program the trigger phase angle (TRIG PHASE). In IMM mode, the value of this field is ignored.</p> <p>If the trigger source is set to SET VOLT, this field can be used to specify the rms voltage to program the output to and trigger the measurement on. The voltage value set here should not exceed the maximum voltage range selected or the rms</p>

capability for the waveshape selected on the phase or phases programmed.

TRIG DELAY

The trigger delay field allows the trigger point to be positioned anywhere in the acquisition window. A negative value will provide pre-trigger information on data leading up to the trigger event. The pre-trigger delay cannot exceed the length of the acquisition buffer. See paragraph 4.6.3.3 for details. A positive trigger delay positions the data window after the trigger event. Positive trigger delays can exceed the length of the acquisition buffer in which case the trigger event itself will not be in the buffer any more. The maximum value of the trigger delay is 1000 ms. The default trigger delay value is 0.0 ms which puts the trigger event at the beginning of the acquisition window.

START

The START field is used to start a new acquisition run. To start an acquisition, place the cursor on the START field and press the ENTER key. Once the ENTER key is pressed, the display toggles to the data display mode selected in the VIEW field as soon as the selected trigger event occurs. To return to the HARMONICS/TRACE ANALYSIS menu, press the ENTER key while in the data display mode.

To change display modes without triggering a new acquisition, make the desired changes in the menu and move the cursor to the VIEW field. Once on the VIEW field, press the ENTER key. This will not trigger a new acquisition, which means the original data is retained.

4.2.6 TRANSIENTS Menu



Figure 4-11: TRANSIENTS menu

The transient menu provides access to the transient list data. The iM Series does not support transient programming. The CSW Series has a transient list of up to 100 data points. This is represented by 100 transient step numbers from 0 through 99. From the Transient menu, the desired transient step type can be selected. Based on the user's choice, the relevant transient type sub menu will be shown. The START/EDIT SEQUENCE sub menu allows the user to review and change any transient step or execute the transient list. When executing a transient list, transient steps are executed in an ascending numerical order. Steps that are not defined are skipped.

The following entries can be found in the TRANSIENTS menu:

Entry	Description
VOLT SURGE/SAG	Voltage surges and sags are temporary changes in amplitude. The output voltage will change from its present value to a user specified value for a specified duration. (Sag if the value is lower, surge if the value is higher.) After this period has expired, the output voltage returns to a user specified end value. This value may or may not be the same as the value present prior to the start of the sag or surge.
VOLT SWEEP/STEP	Voltage sweeps cause the output voltage to change from the present value to a user specified end value at a specified rate of change. A voltage step on the other hand is an instantaneous change in output voltage. The new value will be held for the duration period specified by the user. The final output voltage value of a sweep and a step transient step should be different than the value at the start of the transient step or no change in output value will occur.
FREQ SWEEP/STEP	This transient type is similar to a voltage sweep/step except it affects the frequency. Refer to the previous paragraph.
VOLT/FREQ SWEEP/STEP	This transient type combines the previous two types into a single step. The effect is that of changing the output voltage and frequency simultaneously. Note: While this transient is programmed as a single transient step, two list entries are required to store this information. As such, every VOLT/FREQ SWEEP/STEP used will consume two list entries at a time.
START/VIEW SEQUENCE	This entry allows the user to switch to the transient execution menu. This menu provides a list of all available transient list steps and their sequence numbers. From this menu, transient list execution can be started. The same menu can be used to view or edit any available transient list step or erase a step using the backspace key.

4.2.6.1 VOLT SURGE/SAG sub menu

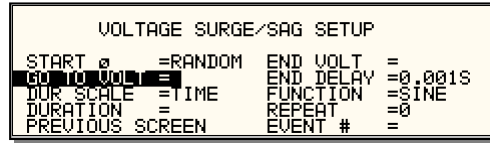

Figure 4-12: VOLTAGE SURGE/SAG SETUP screen

The Voltage surge and sag screen shown in Figure 4-12 can be reached from the transient screen as follows:

1. Scroll to the VOLT SURGE/SAG entry using the up and down cursor keys.
2. Press the ENTER key to bring up the VOLT SURGE/SAG screen.

The VOLT SURGE/SAG screen has several data fields. All data fields that are blank to the right of the equal sign must be filled or an error message will occur when trying to leave this screen. The EVENT # is the last data field to be filled. Entering the event data field will cause the display to return to the TRANSIENT screen where a new selection can be made.

The VOLT/SURGE/SAG screen has the following fields:

START ϕ	This field will show the start phase angle of the voltage transient in degrees. Only one start phase angle per transient sequence is allowed. The start phase angle must be in the first transient event in the list. The start phase angle is not valid for DC transients. If no start phase angle is required, this field can be set to RANDOM by pressing the BACKSPACE (<-) key on the decimal keypad.
GO TO VOLT	This field will set the voltage level during the transient duration in volts
DUR SCALE	Duration scale default is time in seconds. Use the Shuttle knob to select CYCLES if desired. Note that durations expressed in cycles may cause rounding errors if the period of the selected frequency setting is not an integer number of mss. Thus, for 50 Hz applications, no rounding errors occur but for 60 Hz, the 16.66 ms period will cause a rounding error when converted. The Duration scale selection affects both the DURATION and END DELAY parameters.
DURATION	Duration is the time the output voltage level will dwell at the GO TO VOLT level. The DUR SCALE defines the time scale of this parameter in CYCLES or SECONDS
END VOLT	This is the output voltage level at the end of the transient EVENT and after a time specified by the DURATION
END DELAY	This is the time delay the voltage level will stay at the END VOLT level before it proceeds with the next transient event or completes the transient.
FUNCTION	This field can be used to select the waveshape to be used during this step of the transient sequence. Each step can use a different waveshape from the available library of 50 user defined waveforms or the three standard waveforms. The output waveshape changes upon entry into each step and remains in effect for the duration of the step. The default waveshape is always the SINE (sinewave).

REPEAT	This is the number of times the SURGE/SAG transient event will repeat before it will proceed to the next event or exit the transient program. Note that the number of times the transient event is generated is equal to the REPEAT + 1. Leave this value at zero if only one execution of this event in the list is required.
EVENT #	This must be the last item in the transient edit screen. All data fields must be entered before inserting the EVENT #. The EVENT # takes a value from 1 to 99. The EVENT # defines the order of execution of the transient events in a multiple event transient. It is a good practice to enter spaced EVENT #'s to allow insertion of an EVENT later if needed. (For example, space them by 5.) Entry of a sequence EVENT # number will cause the display to return to the TRANSIENT screen.

4.2.6.2 VOLTAGE SWEEP/STEP sub menu



Figure 4-13: VOLTAGE SWEEP/STEP SETUP screen

The Voltage sweep and step screen shown in Figure 4-13 can be reached from the transient screen as follows:

1. Scroll to the VOLT SWEEP/STEP entry using the up and down keys.
2. Press the ENTER key to bring up the VOLTAGE SWEEP/STEP screen.

The VOLTAGE SWEEP/STEP screen has several data fields. All data fields that are blank to the right of the equal sign must be filled or an error message will occur when trying to leave this screen. The EVENT # is the last data field to be filled. Entering the event data field will cause the display to return to the TRANSIENT screen where a new selection can be made.

The VOLTAGE SWEEP/STEP screen has the following fields:

START	This field will show the start phase angle of the voltage transient in degrees. Only one start phase angle per transient sequence is allowed. The start phase angle must be in the first transient event in the list. The start phase angle is not valid for DC transient.
END VOLT	This is the output voltage level at the end of the transient event in volts.
DUR SCALE	Duration scale default is time in seconds. Use the Shuttle knob to select CYCLES if desired. Note that durations expressed in cycles may cause rounding errors if the period of the selected frequency setting is not an integer number of mss. Thus, for 50 Hz applications, no rounding errors occur but for 60 Hz, the 16.66 ms period will cause a rounding error when converted. The Duration scale selection affects both the DURATION and END DELAY parameters.
DURATION	Duration is the time it will take for the output voltage to reach the END VOLT level. As such, "Duration" will define the slew rate of the output voltage for the event. A duration of 0 seconds will cause the output voltage to reach the end voltage immediately. The DUR SCALE defines the time parameter CYCLES or SECONDS
END DELAY	This is the time delay the voltage level will stay at END VOLT before it proceeds with the next transient event or completes the transient.
FUNCTION	[CSW Series only] This field can be used to select the wave shape to be used during this step of the transient sequence. Each step can use a different wave shape from the available library of 50 user-defined waveforms or the three standard waveforms. The output wave shape changes upon entry into each step and remains in effect for the duration of the step. The default wave shape is always the SINE (sine wave).

REPEAT	This is the number of times the VOLTAGE SWEEP/STEP transient event will repeat before it will proceed to the next event or exit the transient program. Note that the number of times the transient event is generated is equal to the REPEAT + 1. Leave this value at zero if only one execution of this event in the list is required.
EVENT #	This must be the last item in the transient edit screen. All data fields must be entered before inserting the EVENT #. The EVENT # takes a value from 1 to 99. The EVENT # defines the order of execution of the transient events in a multiple event transient. It is a good practice to enter spaced EVENT #'s to allow insertion of an EVENT later if needed. (For example, space them by 5.) Entry of a sequence EVENT # number will cause the display to return to the TRANSIENT screen.

4.2.6.3 FREQUENCY SWEEP/STEP sub menu

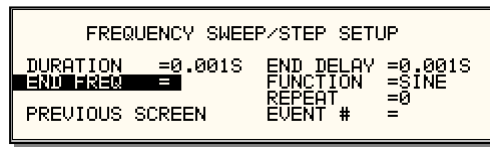

Figure 4-14: FREQUENCY SWEEP/STEP SETUP screen

The Voltage sweep and step screen shown in Figure 4-14 can be reached from the transient screen as follows:

1. Scroll to the FREQ SWEEP/STEP entry using the up and down cursor keys.
2. Press the ENTER key to bring up the FREQ SWEEP/STEP screen.

The FREQ SWEEP/STEP screen has several data fields. All data fields that are blank to the right of the equal sign must be filled or an error message will occur when trying to leave this screen. The EVENT # is the last data field to be filled. Entering the event data field will cause the display to return to the TRANSIENT screen where a new selection can be made.

The FREQ SWEEP/STEP screen has the following fields:

DURATION	Duration is amount of the time the output frequency will take to reach the END FREQ level. Duration will define the slew rate of the output frequency for the event. A duration of 0 seconds will cause the output frequency to reach the end frequency immediately.
END FREQ	This is the output frequency at the end of the transient event in Hz.
END DELAY	This is the time delay the frequency will stay at END FREQ before it proceeds with the next transient event or completes the transient.
FUNCTION	This field can be used to select the waveshape to be used during this step of the transient sequence. Each step can use a different waveshape from the available library of 50 user defined waveforms or the three standard waveforms. The output waveshape changes upon entry into each step and remains in effect for the duration of the step. The default waveshape is always the SINE (sinewave).
REPEAT	This is the number of times the FREQUENCY SWEEP/STEP transient will repeat before it will proceed to the next event or exit the transient. The number of times the transient event is generated is equal to the REPEAT + 1. Leave this value at zero if only one execution of this event in the list is required.
EVENT #	This must be the last item in the transient edit screen. All data fields must be entered before inserting the EVENT #. The EVENT # takes value from 1 to 99. The EVENT # defines the order of execution of the transient events in a multiple event transient. It is a good practice to enter spaced EVENT #'s to allow insertion of an EVENT later if needed. (For example, space them by 5.) Entry of a sequence EVENT # number will cause the display to return to the TRANSIENT screen.

4.2.6.4 VOLTAGE/FREQUENCY SWEEP/STEP sub menu

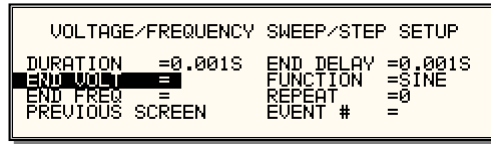

Figure 4-15: VOLTAGE/FREQUENCY SWEEP/STEP SETUP screen

The Volt/freq sweep/step screen shown in Figure 4-15 can be reached from the transient screen as follows:

1. Scroll to the VOLT/FREQ SWEEP/STEP entry using the up and down cursor keys.
2. Press the ENTER key to bring up the VOLT/FREQ SWEEP/STEP screen.

The VOLT/FREQ SWEEP/STEP screen has several data fields. All data fields that are blank to the right of the equal sign must be filled or an error message will occur when trying to leave this screen. The EVENT # is the last data field to be filled. Entering the event data field will cause the display to return to the TRANSIENT screen where a new selection can be made.

The VOLT/FREQ SWEEP/STEP screen has the following fields:

DURATION	Duration is the amount of time the output voltage and frequency will take to reach the END FREQ and END VOLT levels. Duration will define the slew rate of the output voltage and frequency for the event. A duration of 0 seconds will cause the output voltage and frequency to reach their end value immediately.
END FREQ	This is the output frequency at the end of the transient event in Hz.
END VOLT	This is the output voltage at the end of the transient event in volts.
END DELAY	This is the time delay the output frequency and voltage will stay at END FREQ and END VOLT before proceeding with the next transient event or completing the transient.
FUNCTION	This field can be used to select the wave shape to be used during this step of the transient sequence. Each step can use a different wave shape from the available library of 50 user defined waveforms or the three standard waveforms. The output wave shape changes upon entry into each step and remains in effect for the duration of the step. The default wave shape is always the SINE (sine wave).
REPEAT	This is the number of times the VOLTAGE/FREQUENCY SWEEP/STEP transient will repeat before it will proceed to the next event or exit the transient. The number of times the transient event is generated is equal to the REPEAT + 1. Leave this value at zero if only one execution of this event in the list is required.

EVENT # This must be the last item in the transient edit screen. All data fields must be entered before inserting the EVENT #. The EVENT # takes value from 1 to 99. The EVENT # defines the order of execution of the transient events in a multiple event transient. It is a good practice to enter spaced EVENT #'s to allow insertion of an EVENT later if needed. (For example, space them by 5.) Entry of a sequence EVENT # number will cause the display to return to the TRANSIENT screen.

4.2.6.5 START/VIEW TRANSIENT SEQUENCE sub menu

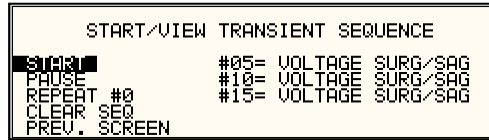

Figure 4-16: START/VIEW TRANSIENT SEQUENCE screen

The START/VIEW TRANSIENT SEQUENCE screen is used to control transient execution. It also provides an overview of available transient list events. This list appears in the order they were assigned event numbers. Editing an existing event can be accomplished from this screen by positioning the cursor on the event to be edited and pressing the ENTER key. This method can also be used to review the parameters of a previously entered event.

The START/VIEW TRANSIENT SEQUENCE screen has the following fields:

START / ABORT	The START field is used to start a transient execution. When the cursor is positioned on the START field and the ENTER key is pressed, transient execution starts. The output relay must be closed or an error message will appear and the transient will not start. Once a transient is in progress, this field changes to ABORT and can be used to abort a transient in progress. If the transient completes execution, the field reverts back to START.
PAUSE / RESUME	The PAUSE field may be used to suspend execution of a transient list in progress. If the cursor is on the PAUSE field and the ENTER key is pressed, the transient is suspended and this field changes to RESUME. Pressing the ENTER key again will cause the transient list to resume execution from the point where it was suspended.
REPEAT #	This field determines the number of times a transient list is repeated. The default value is zero, which means the programmed list runs only once. The range for this field is from 0 through 99999. This repeat function should not be confused with the REPEAT function available for individual events. The event specific repeat value will cause only that event to be repeated, not the entire list.
CLEAR SEQ	Moving the cursor to this field and pressing the ENTER key will cause the entire programmed transient list to be erased. Be careful not to press ENTER accidentally while on this field as you will lose the programmed transient list. Note that a list may be stored as part of the front panel setup in the nonvolatile memory registers.

4.2.7 WAVEFORMS Menu

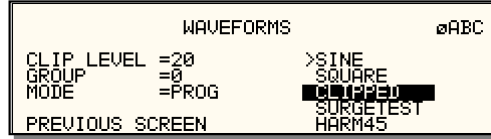

Figure 4-17: WAVEFORMS menu

The WAVEFORMS menu allows selection of the wave shape for each phase individually or all phases at once. For three phase operation the mode is determined by the phase coupling. If only a single phase is selected in the top right corner of the display (øA, øB or øC), the selected wave shape will be applied to that phase. If all phases are selected (phase coupling), the selected waveform will apply to all three phases.

For single-phase versions of the CSW Series, the phase coupling is always set to phase A, so pressing the PHASE button has no effect.

The following fields are available in the WAVEFORMS menu:

CLIP LEVEL	<p>This parameter determines the amount of total harmonic distortion of the built-in CLIPPED sine wave waveform. The range is 0 % through 20 % THD.</p> <p>Note that changing the distortion level of the CLIPPED sine wave while the CLIPPED sinewave is used on the output of one or more phases, forces the output of the AC Source to be dropped momentarily. To avoid this, make sure none of the phases is using the CLIPPED sinewave function when changing the clip level.</p>
GROUP	<p>The group field displays the currently selected waveform group. The CSW Series provides four groups of 50 user defined waveforms each for a total of 200 waveforms. Only one group can be active at a time however. This field only displays the selected waveform group. It cannot be used to change the actual group selected. Group selection must occur at power up and is done from the INITIAL SETUP 3 screen. See section 4.2.11.3 for details.</p>
MODE	<p>The mode field determines the operation mode of the WAVEFORMS display screen. Available options for this field are:</p> <p>PROG: This mode is used to change the programmed wave shape function on the selected phase. This is also the default mode of operation.</p> <p>VIEW(T): This mode can be used to display any of the available user defined waveforms in a time domain display. Previewing a waveform can be useful if you are unsure about the nature of the waveform that was stored.</p>

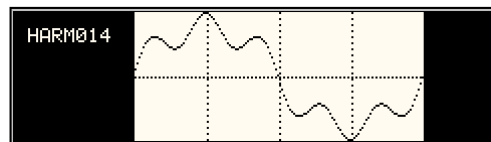

VIEW(F): This mode can be used to display any of the available user defined waveforms in a frequency domain display. Waveform data is shown by harmonic amplitude and phase relative to the fundamental frequency. Previewing a waveform can be useful if you are unsure about the nature of the waveform that was stored.

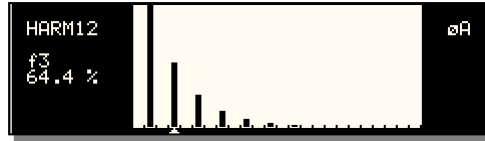

SINE

The SINE is a standard waveform that is always available. It does not consume any of the user defined waveform registers and is always displayed in the waveform list. A right arrow indicates the waveform is presently selected for the phase. If the cursor is moved to this field, the ENTER key will execute the selected MODE. If the mode is set to PROG, pressing ENTER while the cursor is on the SINE entry will select the sine wave for the phase shown in the top right corner of the display.

Note that the VIEW modes are not available for any of the three standard waveforms.

SQUARE

The SQUARE is a standard waveform that is always available. It does not consume any of the user defined waveform registers and is always displayed in the waveform list. A right arrow indicates the waveform is presently selected for the phase. If the cursor is moved to this field, the ENTER key will execute the selected MODE. If the mode is set to PROG, pressing ENTER while the cursor is on the SQUARE entry will select the square wave for the phase shown in the top right corner of the display.

Note that the VIEW modes are not available for any of the three standard waveforms.

CLIPPED

The CLIPPED is a standard waveform that is always available. It does not consume any of the user defined waveform registers and is always displayed in the waveform list. A right arrow indicates the waveform is presently selected for the phase. If the cursor is moved to this field, the ENTER key will execute the selected MODE. If the mode is set to PROG, pressing ENTER while the cursor is on the CLIPPED entry will select the clipped sine wave for the phase shown in the top right corner of the display. The amount of clipping is determined by the CLIP LEVEL field.

Note that the VIEW modes are not available for any of the three standard waveforms.

USER DEFINED

A list of user defined waveforms appears immediately below the three standard waveforms. If no user-defined waveforms were downloaded to the CSW Series AC source, this list will be blank. User defined waveforms can be given a symbolic name of up to twelve characters. The use of any of the three standard waveform names (SINE, SQUARE and CLIPPED) should be avoided, as it will be rejected by the CSW controller.

A right arrow indicates the waveform is presently selected for the phase. If the cursor is moved to this field, the ENTER key will execute the selected MODE. If the mode is set to PROG, pressing ENTER while the cursor is on the user defined entry will select the custom waveform for the phase shown in the top right corner of the display.

If the MODE is set to either VIEW option, the waveform data under the cursor will be displayed when the ENTER key is pressed. Press the ENTER key again to return to the WAVEFORMS menu.

4.2.8 ADVANCE MEAS. Menu

This entry in the MENU 2 screen displays the HARMONICS/TRACE ANALYSIS screen which is covered in section 4.6. This field can be used in lieu of the MEAS key to directly bring up the advanced measurements screens.

4.2.9 APPLICATIONS Menu

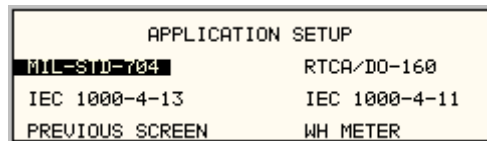

Figure 4-18: APPLICATIONS menu

The APPLICATIONS menu provides access to the optional application specific pre-programmed test sequences. Since these test sequences are optional, this menu may have no choices if none of the options are installed. The following entries may be found in the APPLICATIONS menu:

Entry	Description
MIL-STD 704	Test sequence for MIL standard 704 AC and DC tests.
RTCA/DO-160	Test sequence for RTCA DO160 commercial aviation AC and DC tests.
IEC-1000-4-11	Test sequences for IEC 1000-4-11 Voltage Dips and Variations test standard.
IEC-1000-4-13	Test sequence for IEC 1000-4-13 Harmonics and Inter harmonics test standard.
WH METER	Watt Hour meter measurement option. Tracks energy usage over a period of time and calculates Watt Hours used.

4.2.10 SETUP REGISTERS Menu

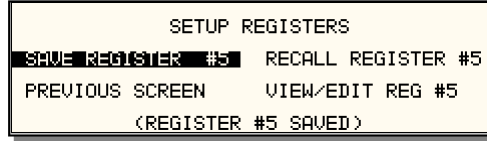

Figure 4-19: SETUP REGISTERS menu

The SETUP REGISTERS menu allows the user to store and recall complete instrument setups, including transient program lists. A total of 16 non-volatile setup registers is available, numbered sequentially from 0 through 15.

The following entries can be found in the SETUP REGISTERS menu:

Entry	Description
SAVE REGISTER	Save present instrument setup to a register number selected by the user. The numeric data entry keypad should be used to enter a number between 0 and 15. Once the ENTER key is pressed, all settings are saved. A message will appear at the bottom of the screen to confirm the save operation.
RECALL REGISTER	Recall instrument setup from a register number selected by the user. The numeric data entry keypad should be used to enter a number between 0 and 15. Once the ENTER key is pressed, all settings are recalled. A message will appear at the bottom of the screen to confirm the recall operation.
VIEW/EDIT REGISTER	The View/Edit entry can be used to display the contents of a setup register before it is recalled. After the user enters a register number to view or edit and presses the ENTER key, the PROGRAM screen will appear. All parameters that will be changed by recalling the register will be blinking. If ENTER is pressed again, the register will be recalled and the new values take effect. To edit the register content, change all parameters that need to be changed. Pressing ENTER will save the new values and make them active.

4.2.11 UTILITY Menus

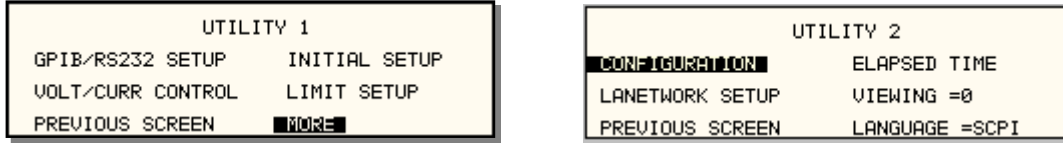

Figure 4-20: UTILITY menus

The UTILITY menus provide access to less frequently used setup items. There is no connection between the various entries in the UTILITY menu other than there is no other logical place to put them. The following entries can be found in the UTILITY menu:

Entry	Description
UTILITY 1	
GPIB/RS232 SETUP	This entry provides access to the setup parameters for either the IEEE-488, RS232C, USB or LAN interface. All parameters are saved in non-volatile memory so there is rarely a need to change these values.
VOLT/CURR CONTROL	<p>The voltage and current control menu can be used to select the voltage range pair, the current limit method, the voltage sense source, and the number of output phases.</p> <p>The standard available voltage range pairs are 156 and 312 volts in all modes, AC or DC.</p> <p>The two current limit choices are Constant Voltage and Constant Current. Constant Voltage mode will maintain the set voltage at the output until the load current exceeds the current limit setting at which time the voltage will be dropped to zero. This effectively shuts off the AC source output in case of an overload condition. This mode has user programmable trip delay which is located in the same menu.</p> <p>Constant Current mode will maintain the load current at the maximum level set by the current limit value, even if the maximum power level is exceeded. This is done by reducing the voltage as needed. As such, the voltage will be reduced from the set level down to zero depending on the load requirement. This mode is useful for starting up motor or capacitor loads that may require a high inrush current. This mode also has a user programmable trip delay.</p> <p>Voltage Reference (VOLT REF) will select between the internal programming reference (INT) an external reference (EXT) or an external gain control (RPV) . The EXT mode will allow an external signal from 0 to 5.0 Vrms to program an output voltage from 0 to full-scale. The RPV mode will allow a DC input from 0 to 7.07 VDC to control the programmed output waveform from 0 to the full-scale output voltage.</p> <p>The number of outputs in a single power source system with can be switched between 5550 VA in the single phase mode or 1850 VA per phase in the three phase mode. In the 1-phase mode the B and C outputs must be manually connected to the Phase A output. These connections must be removed in the 3-phase mode.</p>

INITIAL SETUP The initial setup menu can be used to determine the AC source settings at power up. **CAUTION:** The initial setup can be used to power up the AC source with the output on and a high voltage present at the output. For normal situations, this is not recommended due to the potential danger to operators. It is recommended that the initial voltage be set low and/or the output relay be programmed to OFF for most situations.

LIMIT SETUP The Limit menu shows the frequency, voltage and current limit capabilities of the AC source. Any attempt to program the output beyond these limits will result in a “-222 Data Out of Range error”. Note that these limits are hardware determined and cannot be changed by the user. They are shown for reference only.

UTILITY 2

CONFIGURATION The Configuration menu shows the installed options. This screen is for reference only and no fields can be changed by the user.

LANETWORK SETUP Displays or sets LAN interface settings. If the LAN option is present, this screen may be used to view or change LAN parameters. The MAC address is fixed and cannot be changed. IP and Gateway addresses are normally assigned by the network DHCP server. Changes to the other fields can be made by pressing the SET button first. The indicator in the top right hand of the screen will change from “NC” to “SET”. Note that any setting changes made won't take effect till after the unit has been powered down and back up. To set the LAN interface to AUTO IP mode, set the IP and Gateway address to all zeros. This will cause the IP to be requested from the network the next time power is cycled. To manually set the IP and Gateway address, enter the address from the keypad. The Port address is normally set to 5025. The number of host bits is a function of the network address range.

```

LANetwork Setup          NC
MAC Address =00:00:00:00:00:00
IP Address   =69.35.221.81
GWAddress   =27.205.119.223
PORT Address =5025      HostBits =24
PREVIOUS SCREEN
    
```

To reset the LAN to its default configuration, select the MAC Address and press the SET key followed by ENTER key. Confirm with the ENTER key.

```

LANDefault? Yes = ENTER NO = BackSpace
LANetwork Setup          Set
MAC Address = 00:20:4A:8C:14:A7
IP Address   =10.11.26.163
GWAddress   =10.11.0.1
PORT Address =5025      HostBits = 16
PREVIOUS SCREEN
    
```

ELAPSED TIME The elapsed time screen, when selected from the UTILITY menu, will appear for about 3 seconds. The elapsed time shown is the cumulative amount of time the power source has been on from its initial build. This value is read only and cannot be changed by the user.

The same screen also displays the internal AC source ambient temperature in degrees C.

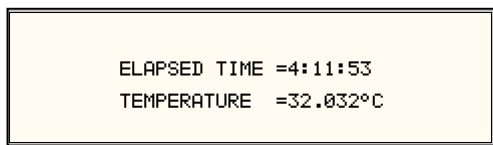

```
ELAPSED TIME =4:11:53
TEMPERATURE =32.032°C
```

VIEWING ANGLE

The viewing angle can be used to change the contrast ratio of the LCD display. The range of the viewing angle parameter is from -10 to +10. Setting the right viewing angle is matter of personal taste. Set this parameter to a value that is most comfortable for the user.

LANGUAGE

The following choices for this field are: **SCPI**; The standard bus syntax for the CSW5550, **SW SCPI**; The bus syntax to match the Elgar SW5550 or SW5250.

4.2.11.1 GPIB/RS232 (incl. USB/LAN) SETUP menu

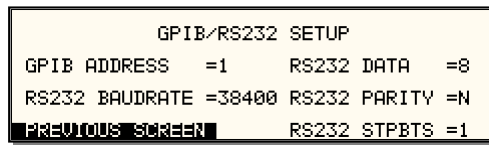

Figure 4-21: GPIB/RS232 SETUP menu

The GPIB/RS232 SETUP menu may be used to change the interface parameter settings for both the IEEE-488 interface and the RS232, USB or LAN serial interface. The number of interfaces available will depend on the specific model and options as well as the time of manufacture. CSW models can be equipped with as many as 4 different interfaces although only one can be used at the same time.

Refer to the CSW Series Programming Manual M162084-03 distributed in Adobe PDF format on the same CD ROM as this user manual for more details on using the RS232, USB or LAN interface.

The following parameters can be set from this menu:

GPIB ADDRESS	Sets the IEEE-488 address used by the AC source. The address value can be set from 0 through 31. Address 0 is often reserved for the IEEE-488 controller. The factory setting is address 1. Once changed, the IEEE-488 address is retained in nonvolatile memory.
RS232 BAUDRATE	This field can be used to set the RS232 baud rate to either 9600, 19,200, 38,400, 57600 or 115,200 baud. The baud rate set on the AC source must match the one programmed for the communications port of the controller. Baud rates higher than 115200 are provided for the USB and LAN interface modes only. The same setting is used for USB and LAN modes. For use with either USB or LAN, the baud rate in this screen must be set to 460800 . See UTILITY 2 screen for other LAN setup parameters.
RS232 DATA	This field is used to set the number of data bits to either 7 or 8. Factory setting is 8 bits. This value must match the number of data bits set on the communications port of the controller.
RS232 PARITY	This field is used to set the parity. Available options are Even (E), Odd (O) or no parity (N). Factory setting is No parity. This value must match the parity set on the communications port of the controller. For USB or LAN use, always use factory settings.
RS232 STPBITS	This field is used to set the number of stop bits used on the serial port. Available options are 1 or 2 bits. Factory setting is 1 stop bit. This value must match the parity set on the communications port of the controller. For USB or LAN use, always use factory settings.

The number of start bits is always fixed to 1 bit.

4.2.11.2 VOLTAGE/CURRENT CONTROL SETUP menu

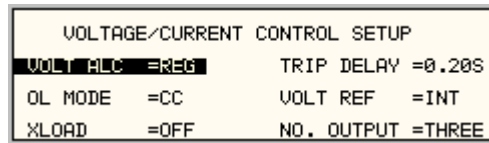

Figure 4-22: VOLTAGE/CURRENT CONTROL SETUP menu

The VOLTAGE/CURRENT CONTROL SETUP menu may be used to set output voltage and current control parameters. These parameters are not frequently changed in the normal operation of the AC source and are thus located on the UTILITY rather than the PROGRAM menu.

The following options are available in this menu:

ALC MODE

Automatic Level Control of programmed output voltage. This mode will use the internal voltage measurements to adjust the output voltage continuously as needed. This effectively increases the output accuracy and regulation beyond what is possible with ALC off.

There are three settings for the ALC mode, ON, REG and OFF.

ON: If ALC is ON, any event or load condition that prevents the power source from regulating the programmed voltage will cause it to trip the output off and generate a -801, "Output Voltage Fault". There may be situations where it is desirable to continue driving the load even if the programmed voltage cannot be maintained.

REG: In the REG (Regulate) mode ALC will regulate the output but not trip the output if for some reason it can't.

OFF: If the ALC is set OFF, no additional regulation is performed by the controller other than the hardware control loop.

Note that if the current limit mode is set to CC (Constant Current) and the ALC is ON, the output will not trip off if the load current is at the programmed current limit forcing the unit into the cc operating mode which requires the voltage to be reduced from the set value.

OL MODE

This field is used to select constant current (CC) or constant voltage (CV) mode. The constant current mode will limit the maximum amount of current drawn by the load to the set value. The voltage will be reduced as needed after the trip delay time to maintain the level of programmed current.

The constant voltage mode will maintain the set voltage as long as the current drawn by the load does not exceed the current limit programmed. If the current limit is exceeded, the output will be shut off after the trip delay time.

TRIP DELAY

The trip delay field may be used to set the amount of time to hold off the current limit trip point. The minimum amount of time is 100 ms or 0.1 sec. The maximum amount of time is 5.00 sec.

VOLT REF The three program options are INT, EXT and RPV. The INT is selected for the normal internal reference for program voltage and frequency. EXT is selected to enable the external signal input. The signal input can be any waveform from 0 to 5.00 Vrms for a 0 to full-scale Vrms output. The RPV mode is the external gain control. A 0 to 7.07 VDC input will control the programmed output waveform from 0 to full-scale Vrms.

NO. OUTPUT This allows the number of output phases to be toggled between single and three-phase mode. In single-phase mode, all power from all three outputs is in phase. The three outputs must be wired together. All programming is for the Phase A function in the 1-phase mode.

4.2.11.3 INITIAL SETUP menu

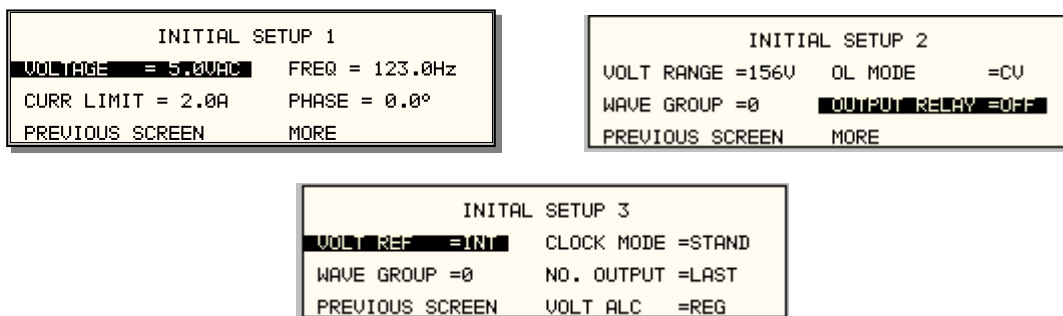

Figure 4-23: INITIAL SETUP menus

Any time the AC source is powered up, the output will reflect the values stored as the INITIAL setup values. This allows the unit to be powered up in a known state at all times. The INITIAL values can be set in the INITIAL SETUP menus.

The initial setup can be used to power up the AC source with the output on and a high voltage present at the output. For normal situations, this is not recommended due to the potential danger to the operator. It is recommended that the initial voltage be set low and/or the output relay be programmed to OFF for most situations.

The following fields are provided in the INITIAL SETUP menus:

Entry	Description
INITIAL SETUP 1	
VOLTAGE	Sets the power-on AC voltage for AC and AC+DC modes or the DC voltage for DC mode.
CURR LIMIT	Sets the power-on current limit value.
FREQ	Sets the power-on frequency value.
PHASE	Sets the power-on frequency for phase A with respect to an external sync signal. If the internal oscillator is used (default) this setting has no effect.
INITIAL SETUP 2	
VOLT RANGE	Sets the power-on voltage range value. The available choices are determined by the VOLT PAIR selected in the VOLTAGE/CURRENT CONTROL SETUP menu.

VOLT MODE	Sets the power-on voltage mode. Available settings are AC mode, DC mode or AC+DC mode.
OL MODE	Sets the power-on overload mode. Available settings are Constant Current (CC) or Constant Voltage (CV) mode.
OUTPUT RELAY	Sets the power-on state of the output relay. Available settings are ON or OFF.

INITIAL SETUP 3

VOLT SENSE	Sets the power-on state of the voltage sense mode. Available settings are Internal (INT) or External (EXT).
WAVE GROUP	Sets the user defined waveform group that will be loaded at power on. Available groups are 0, 1, 2 and 3. Each group can contain up to 50 user-defined waveforms. A waveform group can only be loaded at power up. To change groups, you must change this field to the desired new group and cycle the power to the AC source or issue a *RST command over one bus.
CLOCK MODE	Sets the clock source used at power up. Available settings are Stand Alone (STAND), MASTER, and SLAVE.
NO. OUTPUT	Sets the phase mode at power up. Available options are single phase mode (ONE), three phase mode (THREE) or last used phase mode (LAST).
VOLT ALC	Determines ALC mode at power on. The ALC mode adjusts the output voltage based on internal voltage measurement system and provides enhanced output regulation and accuracy. Available settings are ON, OFF or REG.

4.2.11.4 LIMIT SETUP screen

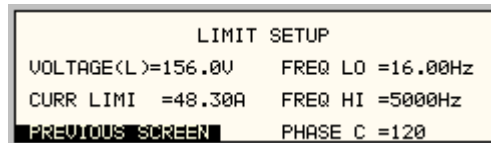

Figure 4-24:LIMIT SETUP menu

The limit setup screen is not a menu but only serves to inform the user of the hardware capabilities of the AC source. The cursor can be moved to any of the fields in this screen but none of these fields can be changed. The following information is provided on this screen:

Entry	Description
VOLTAGE	Maximum AC rms or DC voltage available in the low voltage range.
CUR LIMIT	Maximum AC rms current limit available in the low voltage range which is the sum of the currents for all three phases. It is also the maximum current in the 1-phase mode.
FREQ LO	Lowest possible fundamental frequency that can be programmed.
FREQ HI	Highest possible fundamental frequency that can be programmed.

PHASE C

Phase angle of phase C with respect to phase A in three phase mode. If the AC source is a single phase model, this field will shown 0°. If the AC source is a split phase model, this field will shown 180°.

4.2.11.5 CONFIGURATION SETUP screens

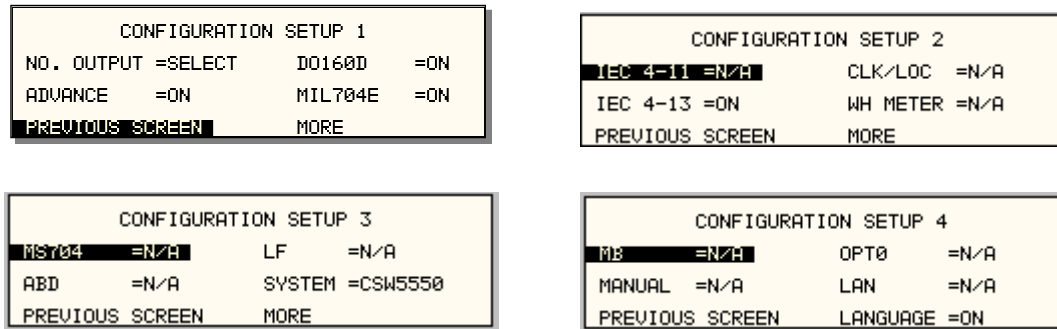

Figure 4-25: CONFIGURATION SETUP Menus

The configuration setup screen is not a menu but only serves to inform the user of the software options installed in the AC source. The cursor can be moved to any of the fields in this screen but none of these fields can be changed. The following information is provided on this screen:

Entry	Description
CONFIGURATION SETUP 1	
NO. OUTPUT	Displays the phase mode option. SELECT indicates the phase mode option is installed and the user can select between single and three phase modes of operation. FIXED indicates the phase mode option is not installed and only single phase or three phase mode of operation is possible.
ADVANCE	This field indicates the presence of advanced capabilities for waveform generation and measurement analysis are present.
DO160	Indicates the presence of the RTCA DO160 test option. If this option is installed, this field will show ON. If this option is not installed, this field will show N/A (not available).
MIL704	Indicates the presence of the MIL/STD-704 Revision D and E test option. If this option is installed, this field will show ON. If this option is not installed, this field will show N/A (not available).
CONFIGURATION SETUP 2	
IEC 4-11	Indicates the presence of the IEC 61000-4-11 test option. If this option is installed, this field will show ON. If this option is not installed, this field will show N/A (not available).
IEC 4-13	Indicates the presence of the IEC 61000-4-13 test option. If this option is installed, this field will show ON. If this option is not installed, this field will show N/A (not available).
CLOCK/LOCK	Indicates the presence of the -LKS clock and lock auxiliary option. For units without -LKS, this field is set to N/A. For units with the -LKS option installed, this field is set to ON. Note that master unit (with -LKM) also has this field set to N/A.

WH METER	Indicates the presence of the Watt Hour Meter option.
	CONFIGURATION SETUP 3
MS704	Indicates the presence of the MIL/STD-704 Revision A through F test option. If this option is installed, this field will show ON. If this option is not installed, this field will show N/A (not available). This field is available on Series II i/CSW systems only.
ABD	Indicates the presence of the ABD0100.1.8 test option. If this option is installed, this field will show ON. If this option is not installed, this field will show N/A (not available).
LF	Indicates the presence of the Low Frequency limit option. If this option is set, the maximum frequency that can be programmed is 500 Hz.
SYSTEM	This field sets the controller for the correct multi box system model configuration. If this field is set incorrectly, the current limit scaling and current measurement will be off by a factor of three. This field is protected and cannot be changed unless the optional MB configuration has been enabled.

NOTE: Options –A350, AMD24 and –B787 are only visible using the *OPT? bus command. Refer to CONFIGURATION SETUP 4 screen.

CONFIGURATION SETUP 4

Note that the fourth configuration screen is only available on models with firmware revision 4.60 or higher. For units with older models, refer to the CONFIGURATION SETUP 3 screen.

MB	This configuration parameter does not exist in the CSW series.
MANUAL	This configuration parameter does not exist in the CSW series.
OPT0, OPT1, OPT2	This field indicates the presence of the following three options: OPT0 = A350 Avionics option (-A350) OPT1 = AMD24 Avionics option (-AMD) OPT2 = B787 Avionics option (-B787) The scroll through the three available OPTn fields, use the shuttle. ON indicates the option is present, N/A indicates the option is not installed.
LAN	This field indicates the presence of the LAN Ethernet interface option. ON indicates the option is present, N/A indicates the option is not installed.

4.2.13 MEASUREMENT CAL FACTORS Menu



Figure 4-26: MEASUREMENT CAL FACTORS menu

The MEASUREMENT CAL FACTORS menu provides access to the measurement calibration parameters. The parameters shown are for the mode of operation (AC or DC) selected. The PHASE key must be used to toggle between the calibration screens for each of the three phases. These parameters are password protected and can only be changed after the calibration password has been entered. Refer to the calibration section in this manual for details on performing a calibration.

The following calibration factors are available from this menu:

Entry	Description
VOLT FS	Full scale voltage measurement calibration factor. AC or DC mode.
CURR FS	Full scale current measurement calibration factor. AC or DC mode.

4.2.14 OUTPUT CAL FACTORS Menu

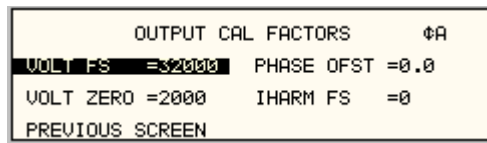

Figure 4-27: OUTPUT CAL FACTORS menu

The OUTPUT CAL FACTORS menu provides access to the output calibration parameters. These parameters are password protected and can only be changed after the calibration password has been entered. For three phase configurations, the PHASE keys toggle between the three calibration screens for each phase. Refer to the calibration section in this manual for details on performing a calibration.

The following calibration factors are available from this menu:

Entry	Description
VOLT FS	Full scale voltage output calibration factor.
V HI-FREQ	High frequency full-scale voltage output calibration factor.
VOLT ZERO	Zero offset voltage calibration factor.
PHASE OFST	Phase offset calibration factor. Compensates for phase shift caused by AC amplifier.

4.2.15 EXTERNAL CAL FACTORS menu

EXTERNAL CALIBRATION		ΦA
FS OUT =1200	ZERO DC = -3	
FS ADC =-663	ZERO RMS =614	
PREVIOUS SCREEN	MEAS RMS/DC =0.0	

Figure 4-28: External Calibration Factors menu

The EXTERNAL CALIBRATION menu provides access to the external input calibration parameters. These parameters are password protected and can only be changed after the calibration password has been entered. The PHASE key toggles between the calibration screens for each of the three phase. Refer to the calibration section in this manual for details on performing a calibration.

The following calibration factors are available from this menu:

Entry	Description
FS OUT	This value is set from 0 to 4095. It will set the External gain with the ALC OFF. The external signal input must be set to the either 5.00 Vac in the EXT mode or +7.07 VDC in the RPV mode while the value is adjusted for either 156 or 312 volts.
FS ADC	This value is to calibrate the converter used for the external input. With the External signal set to either 5.00 Vac in the EXT mode or 7.07 Vdc in the RPV mode the value should be programmed for 312 in the high voltage range.
ZERO DC	This value is to calibrate the External Reference with the relays open. It should be done before FS ADC and ZERO RMS. Enter the value of zero with the relays open and press the ENTER key.
ZERO RMS	N.A.

4.3 Output Programming

4.3.1 Set the Output

Output parameters are all set from the PROGRAM screen.

1. Use the MENU key and select the PROGRAM entry.
 2. Press the ENTER key to bring up the PROGRAM menu.
- or
2. Use the PROG key to directly bring up the PROGRAM menu.

There are two methods for programming output parameters:

IMMEDIATE mode

SET mode

4.3.2 Slewing Output Values with the Knob in IMMEDIATE Mode

The default mode of operation is an immediate mode in which changes to output parameters made with the knob or the entry keypad are immediately reflected at the output.

To change the output voltage:

PROGRAM 1		ΦABC
VOLTAGE = 120.0VAC	VOLT RANGE = 156	
FREQ = 60.00Hz	CURR LIMIT = 15.42A	
PREVIOUS SCREEN		

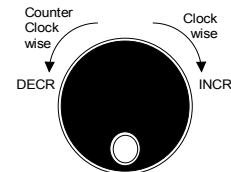

1. Place the cursor on the VOLTAGE entry
2. Rotate the knob clockwise to increase the value, counterclockwise to decrease the value

These changes take effect immediately.

To change the output frequency:

PROGRAM 1		ΦABC
VOLTAGE = 120.0VAC	VOLT RANGE = 156	
FREQ = 78.60Hz	CURR LIMIT = 15.42A	
PREVIOUS SCREEN		

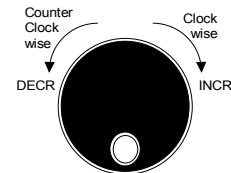

1. Place the cursor on the FREQ entry
2. Rotate the knob clockwise to increase the value, counterclockwise to decrease the value

These changes take effect immediately.

4.3.3 Change Output Values with the Knob in SET Mode

The SET mode of operation is a mode in which changes to output parameters made with the knob or the entry keypad do not affect the output until the ENTER key is pressed. The AC source is put in this SET mode by pressing the SET key.

To change the output voltage:

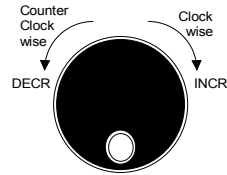
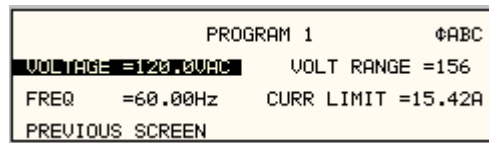

1. Press the SET key
2. Place the cursor on the VOLTAGE entry
3. Rotate the knob clockwise to increase the value, counterclockwise to decrease the value
4. The VOLTAGE field will be blinking to indicate a change in settings but the output remains unchanged.
5. Place the cursor on the FREQ entry
6. Rotate the knob clockwise to increase the value, counterclockwise to decrease the value
7. The FREQ field will be blinking to indicate a change in settings but the output remains unchanged.
8. Press the ENTER key.

Both new voltage and frequency output values are now present at the output. The unit has returned to immediate mode of operation until the SET key is pressed again.

4.4 Waveform Management

The CSW Series employs independent arbitrary waveform generators for each phase. This allows the user to create custom waveforms. In addition, the CSW offers three standard waveforms that are always available. This chapter covers issues that relate to defining, downloading and managing custom waveforms.

4.4.1 Standard Waveforms

For many AC applications, a sine wave shape is used. The sine wave is one of the standard waveforms provided on the CSW Series. The standard sine wave is always available and is the default waveform at power-on. In addition to the sine wave, two more standard waveforms are available, square and clipped.

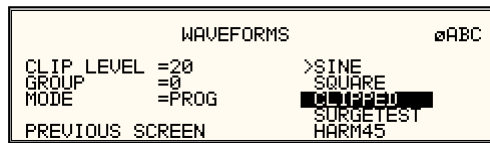

Figure 4-28: Selecting a waveform

The square wave provides a high frequency content waveform with relative fast rise and fall times. Due to AC amplifier bandwidth limitations, the frequency content of the standard square wave has been kept within the amplifier's capabilities. As the fundamental frequency is increased, the relative contribution of higher harmonics is reduced.

The clipped sine wave may be used to simulate voltage distortion levels to the unit under test. The total harmonic distortion level may be programmed in percent using the CLIP LEVEL field of the WAVEFORMS menu. Changing the distortion level of the CLIP waveform forces the AC source to regenerate the CLIPPED sine wave's data points and reload the waveform register with the newly requested data. This process requires the output to be dropped briefly. To avoid interrupting the voltage output to the unit under test, select a different waveform such as the standard sine wave first, change the clip level and change the waveform back to the CLIPPED sine wave. This will avoid any output interruption.

4.4.2 Phase Selection



Figure 4-29: Selecting waveforms for single phase or all phases

Different waveforms may be selected for each phase. The number of custom waveforms from which to select remains 50 but each phase can be assigned a different custom or standard waveform. The specific output phase for which the wave shape is programmed is selected with the PHASE key on the front panel. The selected phase is always shown in the top right hand corner of the WAVEFORMS display.

To select the same wave shape for all three phases in a three phase configuration, press the PHASE key until the øABC enunciator appears in the top right corner of the WAVEFORMS menu. Waveform selections made in this mode will apply to all three phases.

4.4.3 Creating Custom Waveforms

The CSW Series provides four groups of 50 custom defined waveforms each for a total of 200 waveforms in addition to the 3 standard waveforms. Of these four groups, one may be active at a time. The active group is selected in the INITIAL SETUP menu.

Custom waveforms cannot be created from the front panel of the CSW Series. Rather, they have to be downloaded through the IEEE-488 or RS232C interface. A Windows based program is included with the CSW Series that allows waveforms to be created and downloaded easily. This Graphical User Interface program allows waveforms to be created by specifying harmonic amplitudes and phase angles with respect to the fundamental. It also offers an arbitrary waveform data entry mode that allows individual data points to be specified.

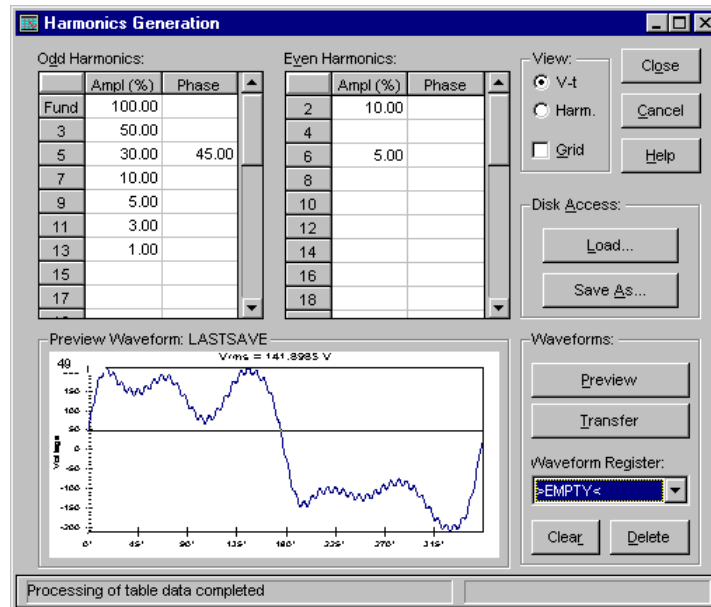

Figure 4-30: Custom waveform creation with GUI program

Once downloaded, waveforms remain in non-volatile memory and will be visible in the WAVEFORMS menu for selection. The user can assign a 12-character name to each custom waveform. Avoid using any of the standard waveform names (SINE, SQUARE or CLIPPED) as these names will not be accepted.

Waveforms may be deleted using the IEEE-488 or RS232C interface as well. Custom waveforms cannot be deleted from the front panel however to avoid accidental erasure.

4.4.4 Waveform Groups

Waveform groups extend the number of available custom waveform to 200. Each group can contain up to 50 user defined waveforms. Groups are numbered 0 through 3 and may be selected from the INITIAL SETUP 3 menu. To switch waveform groups, proceed as follows:

1. Press the MENU key three times to select the MENU 3 screen.
2. Move the cursor to the UTILITY entry and press ENTER. You are now in the UTILITY 1 menu.
3. Move the cursor to the INITIAL SETUP field and press ENTER. You are now in the INITIAL SETUP 1 menu.
4. Move the cursor to the MORE field at the end of this menu and press the ENTER key. You are now in the INITIAL SETUP 2 menu.

5. Move the cursor to the MORE field at the end of this menu and press the ENTER key. You are now in the INITIAL SETUP 3 menu.
6. Move the cursor to the WAVE GROUP = field. You can now use the knob or the 0 through 3 key on the front panel to select a different waveform group.
7. Press ENTER to confirm your new selection.
8. To activate your new selection, YOU MUST CYCLE THE POWER so the AC source re-initializes. If the source is operated over the bus, a IEEE-488 Device Clear or reset command (*RST) command will have the same effect.

The new wave group will be active after you turn the power to the unit back on.

4.4.5 RMS Amplitude Restrictions

The output of a sinewave may be programmed to the full rms value of the voltage range selected. If the source is in the 312 V range, the maximum programmable rms voltage is 312 Volt. If a custom waveform is used however, the maximum programmable rms voltage may be less than the maximum range value. The voltage range limit is based on the use of a sine wave with a 1.414 crest factor. A 312 V rms sine wave has a 441 Volt peak voltage. The AC source has a maximum peak voltage capability that is determined by the selected voltage range. If the user selects a custom waveform with a crest factor that is higher than 1.414, the peak voltage would exceed this maximum if the rms voltage were to be programmed at 312 V rms.

The CSW Series automatically limits the maximum allowable programmed rms voltage of a any custom waveform by calculating the crest factor of the selected waveform and controlling the rms limit accordingly. Thus, each custom waveform may have a different maximum rms value. The CSW controller will prevent the user from programming the rms voltage above this limit. If a value is entered in the PROGRAM 1 menu above this value, a "Voltage peak error" message is generated.

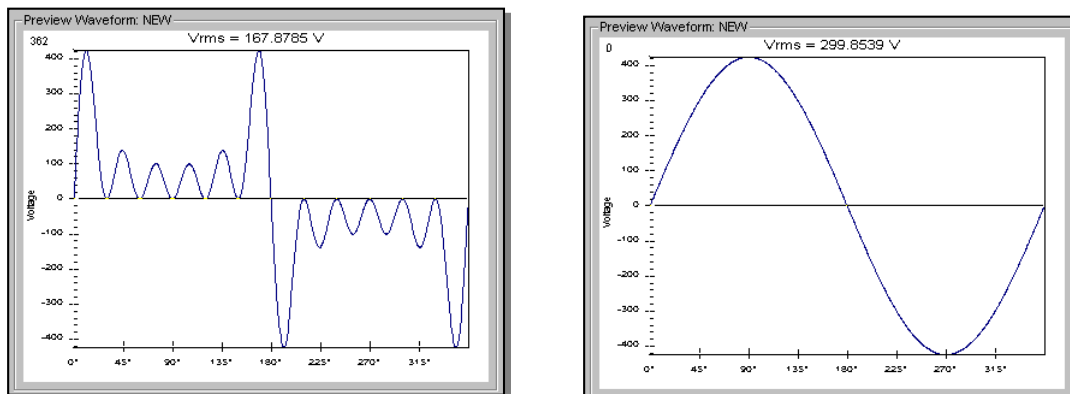

Figure 4-31: Waveform crest factor affects max. rms voltage

The figure shown here illustrates the relationship between the crest factor of the wave shape (or its "peakiness") and the maximum peak voltage allowed for a given voltage range. Since the peak voltage cannot exceed the AC source's capabilities, the programmable rms voltage has to be restricted, in this case to only 167.8785 volt for the waveform on the left. The sine wave on the right can be programmed to the full 312 V rms as this still falls within the same peak voltage limitation of the AC source.

If the CSW Series is used through the bus, the :VOLT? MAX query can be used to determine the maximum allowable rms voltage for the selected waveform. Using the returned value as part of a program will prevent range errors.

4.4.6 Frequency Response Restrictions

The user may create a waveform that contains any number of harmonic frequencies of the fundamental. The AC Source itself however has a finite signal bandwidth and will attenuate higher frequency components of the signal. To limit the maximum frequency component of the output signal, the CSW controller automatically applies a band-pass filter to all custom waveforms as they are downloaded.

The controller implements the following process for user-defined waveforms:

Each down loaded waveform will have a computed frequency limit that is less than or equal the maximum frequency limit of the AC source. The frequency limit is a function of the harmonics content of the waveform and will follow the equation below.

$$F_{max_h} = F_{max}/(\text{level} * h_n)$$

If F_{max_h} is below the minimum frequency limit, the waveform will be rejected at down load time and the label will be deleted from the waveform catalogue.

If the power source is used over the bus, the “:FREQ? MAX” query command can be used to determine the maximum allowable fundamental frequency for the selected waveform. Using the returned value as part of a program will prevent range errors.

Limits assume a program of full-scale voltage. No adjustments for voltage setting are made below the full-scale value.

Waveform selection and frequency programming will be subject to the above limit. An error message will be generated to reflect this type of error:

"22,Waveform harmonics limit"

Transient editing will also generate the above error during keyboard entry. Remote transient entry will not check for the error until transient execution.

The frequency domain VIEW mode in the WAVEFORMS menu may be used to visualize the content of each custom waveform register on the LCD.

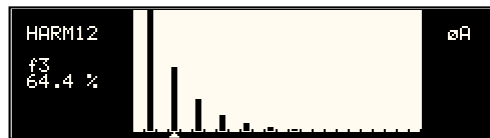

Figure 4-32: Waveform frequency domain view mode

4.4.7 Switching Waveforms

Waveforms can be switched as part of the transient system. Each transient type setup menu has a FUNCTION field. This field allows selection of any of the standard or custom waveforms available in the selected group. Refer to the section on transients for more details on using transient list to switch output waveforms.

4.5 Standard Measurements

Standard measurements are always available through the MEAS key on the front panel. These measurements are spread across two to four screens to enhance readability. Switching between these screens can be done by successively pressing the MEAS button on the front panel. This will cause the screen to cycle through all available measurement screens.

4.5.1 CSW Series Measurements

For CSW Series, the following four measurement screens are available:

Mode	AC	DC	AC+DC
MEASUREMENTS 1			
VOLTAGE	AC rms voltage	DC Voltage	AC rms voltage
CURRENT	AC rms current	DC Current	AC rms current
FREQUENCY	Frequency	n/a	Frequency
POWER	Real power	Power	n/a
MEASUREMENTS 2			
VA POWER	Apparent power	power	Apparent power
PEAK CURR	Highest AC current found	Highest DC current found	Highest AC current found
POWER FACT	Power factor	n/a	Power factor
CREST FACT	Crest factor	n/a	Crest factor
MEASUREMENTS 3			
VOLT THD	Voltage distortion	n/a	Voltage distortion
CURR THD	Current distortion	n/a	Current distortion
INST PK CURR	Instantaneous peak current	Highest DC current found	Instantaneous peak current
PHASE	Phase angle	n/a	Phase angle

The CSW Series has a fourth measurement screen for harmonics and trace analysis measurements. This subject is covered in the next chapter.

Measurements are always running in the background. When the user selects a measurement screen for display, the AC source first updates all the measurement parameters before displaying the requested screen. This process may take up to a second. Consequently, pressing the MEAS key may not always bring up the selected screen immediately. There will be a perceptible delay. This will prevent the screen from appearing with invalid or blank readouts.

The measurement method for voltage and current will depend on the power source operating mode. The following table shows the return value type (rms or average) and method of coupling when the measurement command is initiated with a different extension at various operating modes (AC, DC or AC + DC).

Measurement Extension and Coupling	Operating Mode		
	AC	DC	AC + DC
AC	rms	rms	rms
DC	rms	rms	average
Coupling	AC	DC	DC

4.5.2 Accuracy Considerations

Any measurement system has a finite accuracy specification. Measurement specifications are listed in Section 2. When using the AC source for measurement purposes, always consider these specifications when interpreting results. Measurement inaccuracies become more pronounced as the signal being measured is at the low end of the measurement range. This is particularly relevant for low current measurements. The CSW Series are high power AC sources optimized for providing and measuring high load currents. When powering low power loads, measurement inaccuracies on rms and peak current measurements will greatly affect derived measurements such as power, power factor and crest factor.

The measurement system on the CSW Series uses a data acquisition system with a 16 kHz bandwidth. This means that high frequency components of the measured signal are filtered out. Any contribution to the rms value of voltage and current above this cutoff frequency will not be reflected in the CSW Series measurements. When using an external measurement reference, this may account for discrepancies in readings.

4.6 Advanced Measurements

The CSW Series offers advanced power analyzer measurement capabilities. These functions may be accessed from the MEAS button or the MENU 2 screen. The phase for which the analysis or waveform acquisition is done may be selected using the PHASE key in three phase configurations. This chapter covers the use and application of these advanced measurement functions.

4.6.1 Harmonic Analysis

The CSW power analyzer performs fast fourier transformation on both voltage and current on each available phase. The resulting frequency spectrum can be displayed on the LCD display in a tabular as well as a graphical mode.

4.6.1.1 Acquiring FFT data

To perform an FFT analysis on the output of the AC source, proceed as follows:

1. Press the MEAS button four times or until the HARMONICS/TRACE ANALYSIS screen appears.
2. Move the cursor to the FUNCTION field and select VOLT or CURR. (The BOTH selection will default to CURR as only one FFT result can be displayed at a time.)
3. Move the cursor to the VIEW field and select the TABLE or BAR display mode. The TRACE display mode does not apply to FFT results.
4. Move the cursor to the DATA MODE field and select ABS or REL. Absolute display mode will show all harmonic components in volts or amps. Relative display mode will use the fundamental as a 100 % reference and display all harmonics as a percentage of the fundamental. Phase angles are always shown with respect to the fundamental frequency. The phase angle of the fundamental is always shown with respect to phase A.
5. Skip the SCALE field as it only applies to the TRACE display mode.
6. Move the cursor to the TRIG MODE and select SINGLE or CONT. The SINGLE mode will acquire the data once and show the result. If you select CONT, the data will be updated continuously.
7. Move the cursor to the TRIG SOURCE field and select IMM. We will cover additional trigger modes later.

8. Move the cursor to the START field and press the ENTER key. The display that you selected will be shown. If you are in CONT trigger mode, the data will be updated about once per second.

You can return to the HARMONICS/TRACE ANALYSIS screen by pressing the ENTER key. To display the data in a different format, change to the selections you want and move the cursor to the VIEW field. Pressing the ENTER key will re-display the data without triggering a new acquisition. (This is true even if you were in CONT trigger mode.) To start a new acquisition, you must go through the START field instead.

4.6.1.2 Analyzing FFT data

The data displays available for FFT data allow you to scroll through the entire data set. For table displays, the UP and DOWN arrow keys may be used to scroll through the table data vertically. The knob has no function while in this display mode. The triangle on the left edge of the LCD screen points to the current position in the table.

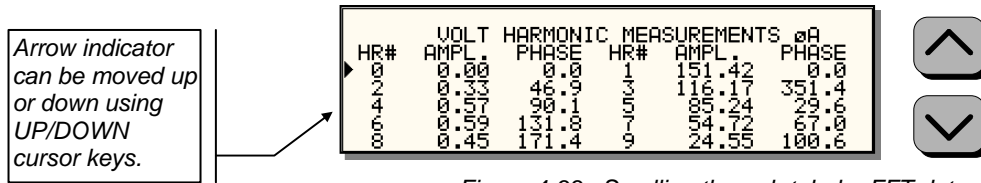

Figure 4-33: Scrolling through tabular FFT data

Bar chart format FFT data displays show the same data in a graphical format. While the amplitude information is shown graphically, phase data is only displayed in numeric form to the left for the currently selected harmonic component. The display can show up to 24 components at a time. The triangle at the bottom of the display shows the currently selected component for which numeric data is shown on the left. This data includes the harmonic number (DC through 50), the absolute or relative amplitude (depending on selected VIEW mode) and the phase angle with respect to the fundamental. The knob can be used to scroll through the display horizontally. The UP and DOWN cursor keys have no effect in this display mode.

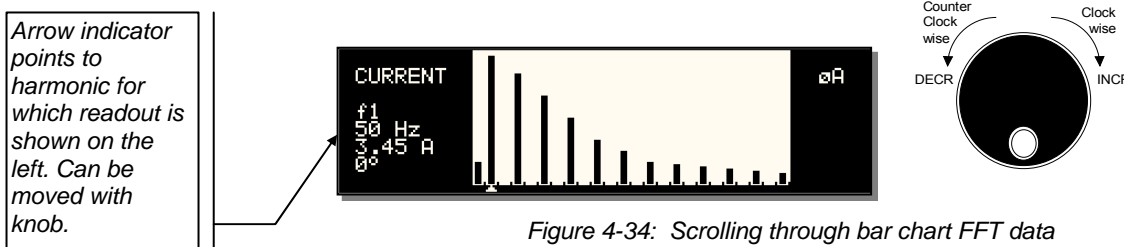

Figure 4-34: Scrolling through bar chart FFT data

4.6.2 Waveform Acquisition

The waveform acquisition mode allows voltage and/or current data waveforms to be captured and displayed. This mode is selected by choosing the VIEW =TRACE mode in the HARMONICS/TRACE ANALYSIS screen. Voltage and current may be viewed separately or combined into a single display using the FUNCTION field.

4.6.2.1 Acquiring waveform data

To perform a waveform acquisition on the output of the AC source, proceed as follows:

1. Press the MEAS button four times or until the HARMONICS/TRACE ANALYSIS screen appears.
2. Move the cursor to the FUNCTION field and select VOLT, CURR or BOTH.
3. Move the cursor to the VIEW field and select the TRACE display mode.
4. Skip the DATA MODE field as it only applies to the TABLE and BAR display modes.
5. Move the cursor to the SCALE field and select a horizontal time base value to allow you to see at least one cycle of the output waveform. If the output is programmed at 50 Hz, a 20 ms scale would display exactly one signal period.
6. Move the cursor to the TRIG MODE and select SINGLE or CONT. The SINGLE mode will acquire the data once and show the result. If you select CONT, the data will be updated continuously.
7. Move the cursor to the TRIG SOURCE field and select IMM. We will cover additional trigger modes later.
8. Move the cursor to the START field and press the ENTER key. The display that you selected will be shown. If you are in CONT trigger mode, the data will be updated about once per second.

You can return to the HARMONICS/TRACE ANALYSIS screen by pressing the ENTER key. To display the data in a different format or to select voltage instead of current or current instead of voltage, change to the selections you want and move the cursor to the VIEW field. Pressing the ENTER key will re-display the data without triggering a new acquisition. (This is true even if you were in CONT trigger mode.) To start a new acquisition, you must go through the START field instead.

4.6.2.2 Analyzing waveform data

The data displays available for acquired waveform data allow you to scroll through the entire acquisition buffer. For waveform displays, the knob can be used to scroll through the display horizontally. The UP and DOWN cursor keys have no effect in this display mode.

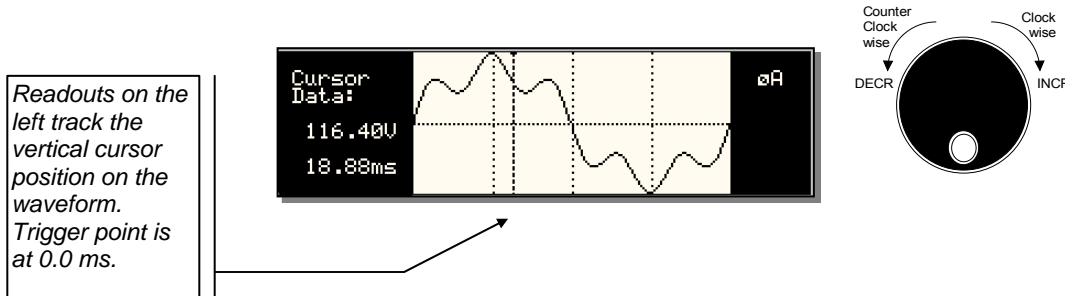

Figure 4-35: Scrolling through acquired waveform data

The acquisition buffer may be longer than the selected horizontal scale in which case only a portion of the acquisition window will be visible. The left portion of the LCD display is used to read out the data under the vertical cursor. This cursor is a dotted line that can be moved using the knob. If the left or right edge of the display window is reached, the entire display will shift so the cursor always remains visible. The time from the trigger point to the vertical cursor is displayed in the left hand portion of the LCD in ms. Also displayed here are the absolute voltage and/or current value under the cursor.

To change the horizontal display scale without re-triggering an acquisition, press the ENTER key to return to the HARMONICS/TRACE ANALYSIS screen, change the SCALE value, move the cursor to the VIEW field and press ENTER. This will display the same data set at the new scale without triggering a new acquisition.

4.6.3 Triggering Measurements

Both FFT results and waveform acquisitions may have to be positioned at a specific moment in time. To allow the data acquisition to coincide with user specified events, the measurement system can be triggered in different ways. Trigger modes are available from both the bus and the front panel. If the IEEE-488 or RS232C bus is used, acquisitions may also be triggered from the transient list system. Refer to the programming manual for details on this mode of operation.

4.6.3.1 Trigger mode

The following trigger modes are supported by the CSW Series:

- | | |
|-------------------|---|
| Single (SINGLE) | This mode causes the acquisition system to be armed only once. The CSW source waits for the user to press the ENTER key while on the START field. As soon as the trigger event specified occurs, data is acquired and the acquisition system is put in an idle state. A new user initiated START event must be given to trigger an new acquisition. |
| | This mode is appropriate for capturing events that occur only once such as the inrush current when turning on a load. |
| Continuous (CONT) | This mode causes the trigger system to re-arm itself after each trigger event. Every time a new trigger event occurs, new data is acquired and the LCD display is updated. No user intervention is required after the initial START event. |

This mode is appropriate for capturing repetitive events or to monitor the source output continuously. Display updates will occur about once per second.

4.6.3.2 Trigger source

The CSW Series offers a choice of trigger sources in front panel operation mode. The following trigger sources are available from the HARMONICS/TRACE ANALYSIS, TRIG SOURCE field:

Immediate (IMM) This mode causes a trigger to occur as soon as the ENTER key is pressed with the cursor on the START field. No trigger source needs to be specified for this trigger mode. This mode is equivalent to the INIT:IMM:ACQ bus command.

This trigger source is appropriate if no trigger condition is known or desired. When using this trigger source, the acquisition is always triggered.

Phase (PHASE A) This mode causes the CSW acquisition system to wait for a specified phase angle on the phase A voltage output. This allows the acquisition to be positioned in time with respect to any phase angle on phase A, B or C. Note that phase A, B and C are typically at 0°, 240° and 120° with respect to the specified trigger phase in this field. An example of this trigger source mode is shown in Figure 4-37.

When selecting this trigger source, the field below the TRIG SOURCE field changed to "TRIG PHASE =". Use this field to enter the desired voltage phase angle to trigger the measurement on.

This mode is appropriate when capturing analyzing events at a specific phase angle such as the zero crossing of the voltage. Note that the phase angle of the current with respect to the voltage is determined by the load, so triggering at a specific phase current angle is not possible as it is not controlled by the AC source. However, when capturing current waveform data, the phase relationship to the voltage can be determined easily by triggering at the 0° point on the voltage.

Voltage step (SET VOLT) This mode performs two functions. It programs the output voltage for the selected phase or phases to the rms or DC value specified and it triggers the measurement acquisition at the same moment in time.

When selecting this trigger source, the field below the TRIG SOURCE field changed to "SET VOLT =". Use this field to enter the desired voltage to program the output to and trigger the measurement on. If only one phase in a three phase system is selected, only that phase's output will be programmed. If all phases are selected, all three phases' outputs will be programmed. Use the PHASE key to select the desired phase or all phases. Figure 4-36 shows an example of using the SET VOLT trigger source to capture the turn-on of the voltage. In this case, a negative trigger delay was specified and the voltage start phase angle was set to 90° in the PROGRAM 2 screen.

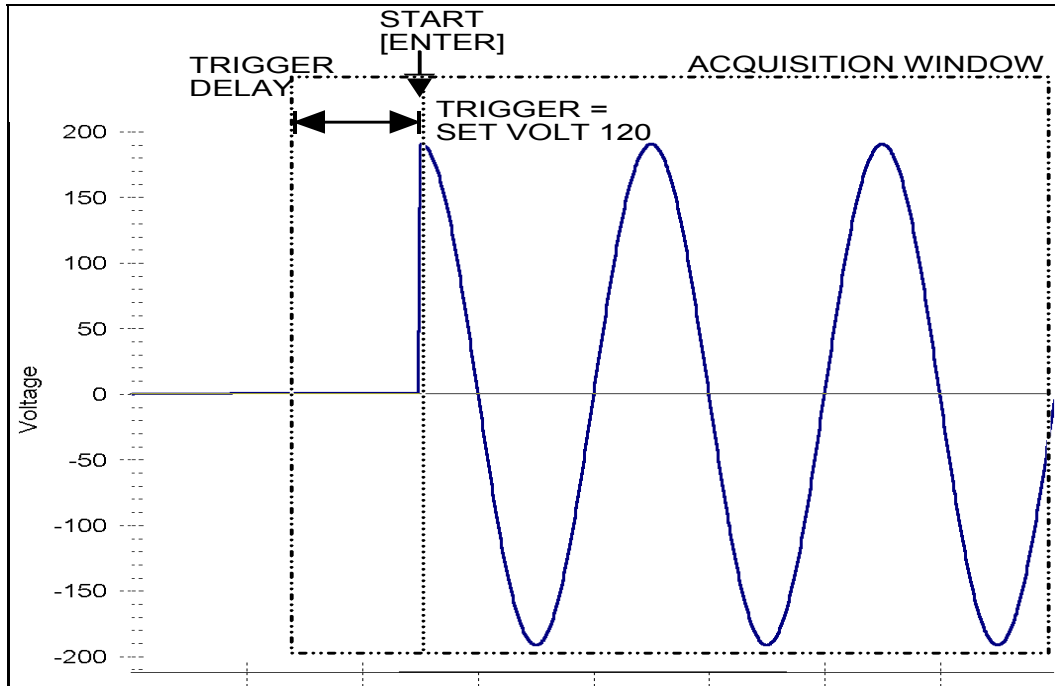

Figure 4-36: SET VOLT trigger source acquisition

This mode is appropriate for capturing the inrush current of a load by programming the voltage to a specified value and capturing the voltage and current at that moment in time. A further refinement can be made by specifying the voltage start phase angle in the PROGRAM 2 screen. If this field is changed from RANDOM to 90°, the inrush current can be captured under worst case conditions. In this case, the voltage should be programmed to 0 volt before triggering the acquisition using the START field.

Note: When using the SET VOLT trigger source, the output relay MUST be closed to generate a trigger. If the output is open, the acquisition will be armed when the START [ENTER] key is pressed but will wait for the trigger event. Closing the output relay will generate the trigger event. If the output relay was already closed when the START [ENTER] key is pressed, the trigger will occur immediately.

4.6.3.3 Trigger delay

The trigger delay field allows the user to set the amount of pre- or post-trigger data that should be used when positioning the data acquisition window with respect to the trigger moment.

POST-TRIGGER DELAY

A positive trigger delay value means the acquisition window is delayed by the amount of time specified. In this case, the actual trigger moment itself is no longer present in the acquisition buffer. This situation is shown in Figure 4-37 where a 20 ms trigger delay is used after triggering on phase A = 180°. The fundamental frequency of the output is 50 Hz. The trigger point is indicated by the dashed line. It occurs on the first 180 degree point that occurs after the user presses the ENTER key while on the START field. Once the trigger occurs, the acquisition holds off the specified 20 ms at which point the data requested is captured. Using a positive trigger delay value always yields post trigger data.

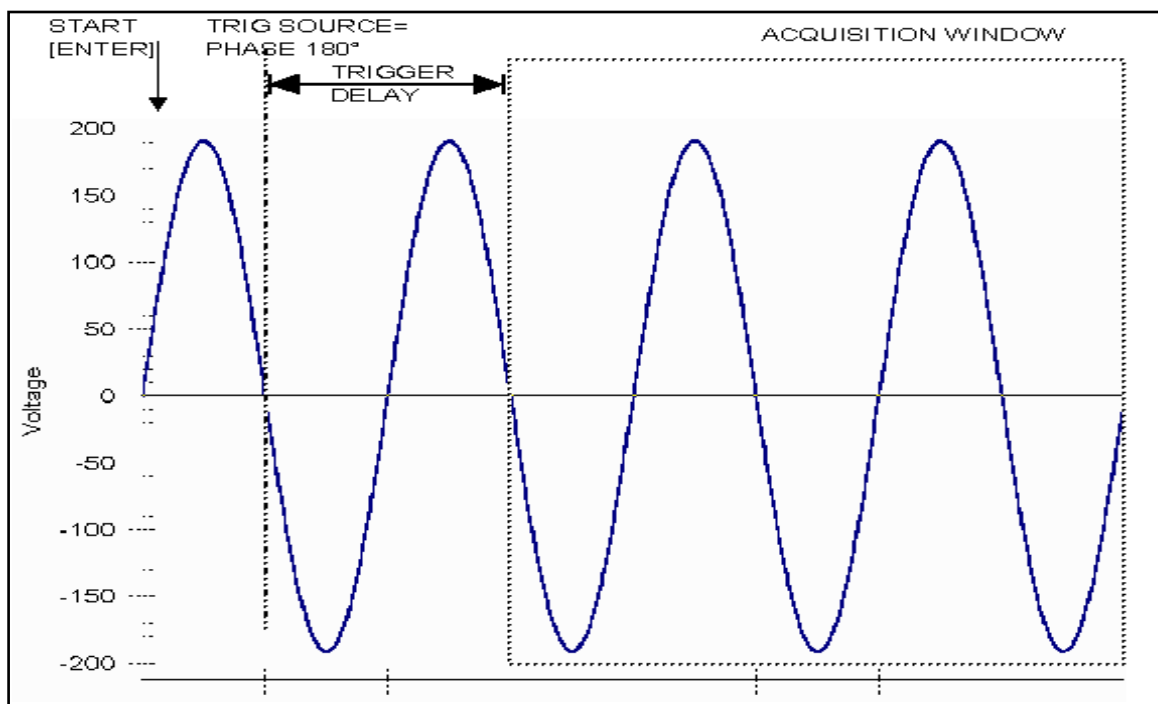

Figure 4-37: Positive trigger delay (Post trigger data)

Positive trigger delay values may be set from 0.0 ms to 1000.0 ms (1 second) in 0.1 ms increments. The value may be entered directly from the keyboard or using the knob.

PRE TRIGGER DELAY

Alternatively, a negative trigger delay value may be specified up to the maximum time window depth of the acquisition window. The value may be entered directly from the keyboard or using the knob. The following time interval range is available:

Single-phase mode: 42.6 msec to 426 msec.

Three-phase mode: 128 msec to 1280 msec.

This situation is shown in Figure 4-38. The example shows a similar scenario as before, only this time the trigger delay was set a -20 ms. Notice that the data acquisition window now contains data that occurred before the user pressed the ENTER key to start the acquisition.

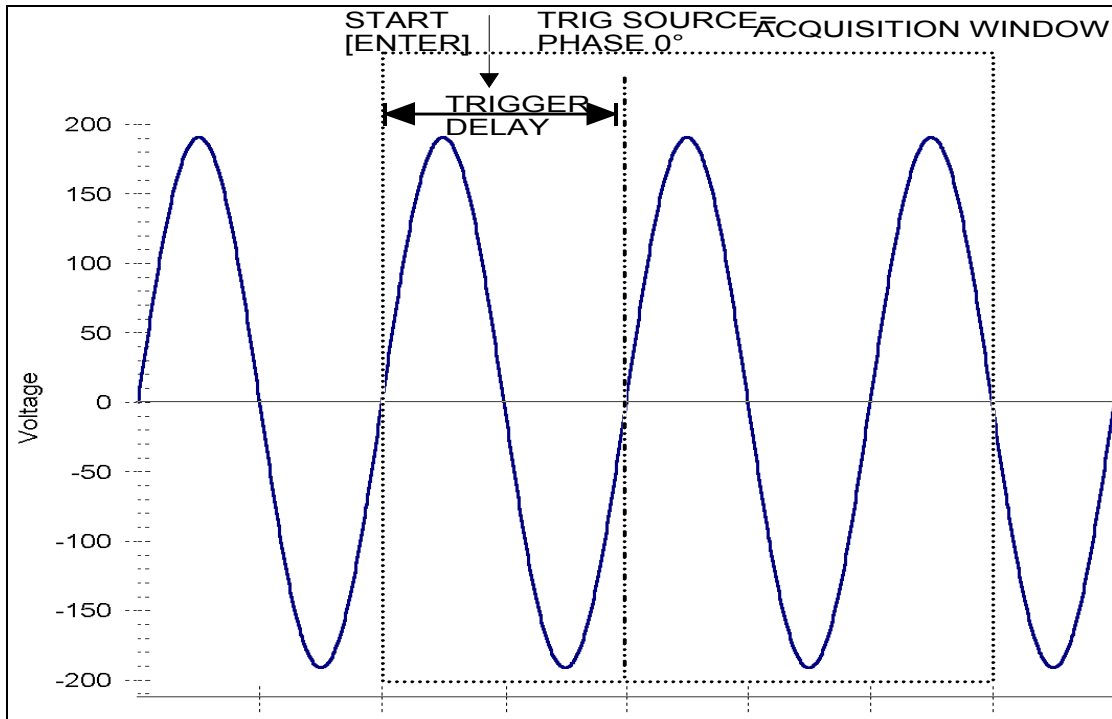

Figure 4-38: Negative trigger delay (Pre-trigger data)

4.7 Transient Programming

4.7.1 Introduction

Transient programming provides a precise timing control over output voltage and frequency changes. This mode of operation can be used to test a product for susceptibility to common AC line conditions such as surges, sags, brownouts and spikes. By combining transient programming with custom waveforms virtually any AC condition can be simulated on the output of the AC source.

The default voltage mode is FIXED which means the output voltage is constant and remains at the level set by the user. Changes made to the output voltage made from the PROGRAM 1 menu take effect immediately. In front panel operation mode, the voltage and frequency slew rates (rate of change) are always at their maximum of $9.9E37$ V/s and $9.9E37$ Hz/s or MAX. Slew rate programming is only possible over the IEEE-488 or RS232C bus. On power up, the AC source always reverts to the maximum slew rate for both voltage and frequency.

4.7.2 Using Transient Modes

The voltage can be programmed in the following transient operating modes:

STEP	causes the output to permanently change to its triggered value.
PULSE	causes the output to change to its triggered value for a specific time, as determined by the Pulse menu parameters.
LIST	causes the output to sequence through a number of values, as determined by points entered in the List menu.
FCSWED	disables transient operation for the selected function.

4.7.3 Step Transients

Step transients let you specify an alternate or triggered voltage level that the AC source will apply to the output when it receives a trigger. Because the default transient voltage level is zero volts, you must first enter a triggered voltage before you can trigger the AC source to change the output amplitude. Step transients can only be programmed through the bus, not the front panel. Refer to the SCPI Programming Manual for more information about programming Step transients and triggers.

4.7.4 Pulse Transients

Pulse transients let you program the output to a specified value for a predetermined amount of time. At the end of the Pulse transient, the output voltage returns to its previous value. Parameters required to set up a Pulse transient include the pulse count, pulse period, and pulse duty cycle. An example of a Pulse transient is shown in Figure 4-39. In this case, the count is 4, the pulse period is 16.6 ms or 60 Hz and the duty cycle is 33%.

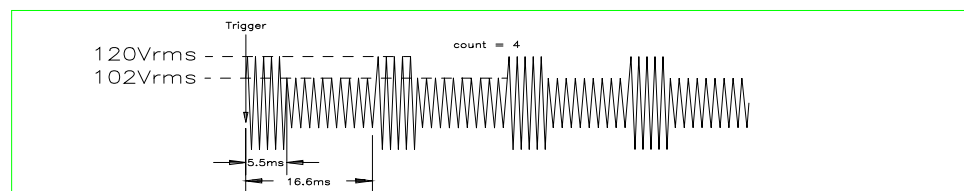

Figure 4-39: Pulse Transients

Note that Pulse transients can only be programmed over the bus, not the front panel. Refer to the SCPI Programming Manual for more information about programming Pulse transients and triggers.

4.7.5 List Transients

List transients provide the most versatile means of controlling the output in a specific manner as they allow a series of parameters to be programmed in a timed sequence. The following figure shows a voltage output generated from a list. The output shown represents three different AC voltage pulses (160 volts for 33 milliseconds, 120 volts for 83 milliseconds, and 80 volts for 150 milliseconds) separated by 67 millisecond, zero volt intervals.

Transient list programming is supported from the front panel and may be accessed by selecting the TRANSIENTS entry in the MENU 1 screen. Transient lists can also be programmed over the bus. Refer to the SCPI Programming Manual for more information about programming List transients and triggers over the bus.

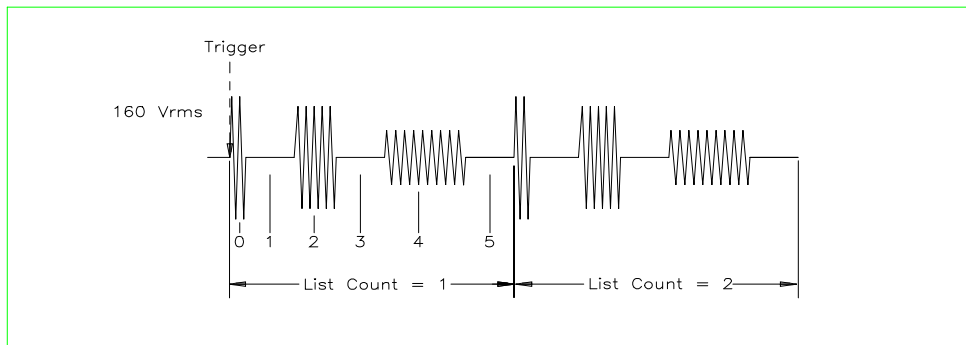
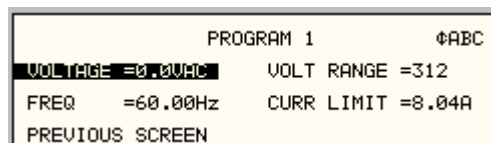

Figure 4-40: List Transients

The list specifies the pulses as three voltage points (point 0, 2, and 4), each with its corresponding dwell point. The intervals are three zero-voltage points (point 1, 3, and 5) of equal intervals. The count parameter causes the list to execute twice when started by a single trigger.

To set up this type of transient list, proceed as follows:

1. Press the PROG key to bring up the PROGRAM 1 menu.
2. Move the cursor to the VOLTAGE field and enter 0 Volt. Press ENTER to confirm your setting.
3. Make sure you are in the HIGH voltage range as we will program a surge to 160 V rms. The low range would only allow 150 V rms.



4. Press the MENU key to bring up MENU 1.
5. Move the cursor to the TRANSIENTS entry and press the ENTER key. You are now in the TRANSIENTS menu.
6. Move the cursor to the VOLT SURGE/SAG entry and press the ENTER key. You are now in the VOLT SURGE/SAG SETUP menu.

7. If you have a three phase configuration and are in the three phase mode, use the PHASE key to select all three phases. (øABC will be displayed in the top right corner of the screen.)
8. The START ø may be left at RANDOM as we are not interested in starting at a specific phase angle. If a number is already present in this field, use the BACKSPACE (<-) key to clear it.
9. Move the cursor to the GO TO VOLT field and enter 160.0
10. Move the cursor to the DUR SCALE field and set this field to TIME. We will be entering delays in time rather than cycles since this example was stated in ms.
11. Move the cursor to the DURATION field and enter 0.033 seconds. Be sure not to enter 33 as this field is specified in seconds, not milliseconds. The highest time resolution available for list transients is 1 ms or 0.001 s.
12. Move to the END VOLT field and enter 0.0. We want the voltage to return to 0 Volt after the first burst.
13. Move the cursor to the END DELAY field and enter 0.067 for a interval delay of 67 ms. Notice that we effectively combined steps 0 and 1 from Figure 4-40 into a single list event.
14. If you have an CSW Series AC source, move down to the FUNCTION field and use the knob to select SINE. The knob will allow you to scroll through all available wave shapes in the active WAVE GROUP. If you have an i Series AC Source, this field will not be visible.
15. Move the cursor to the REPEAT field and enter 0. This means this event will be executed once and not repeated. Do not confuse this event level repeat capability with the entire list level repeat field which we will use later.
16. Move the cursor down to the EVENT # field and enter a number from 1 through 99. The transient list will be executed in order of event number. Leaving a gap between event numbers allows you to insert events at different places later in the sequence. Deleting events is always possible regardless of the event number. For the purpose of this exercise, we will start with EVENT # 5. Enter 5 and press the ENTER key. This brings you back to the TRANSIENTS menu.

```

VOLT SURGE/SAG SETUP      øABC
START ø   =RANDOM          END VOLT   =0.0
GO TO VOLT=160.0         END DELAY  =0.067S
DUR SCALE =TIME           FUNCTION   =SINE
DURATION  =0.033S        REPEAT     =0
PREVIOUS SCREEN          EVENT #    =5

```

17. Repeat steps 6 through 16 two more times using 120 V, 83 ms and 80 V, 150 ms as values for EVENT # 10 and EVENT #15.
18. Once you have programmed these three events, move the cursor in the TRANSIENTS menu to the START/VIEW SEQUENCE field and press the ENTER key. This will get you to the START/VIEW TRANSIENT SEQUENCE menu from which you can run transient programs. This screen shows all available events in the transient list on the right hand side. If more than five events are programmed, you can scroll through the list using the UP and DOWN arrow keys. To edit an existing event, move the cursor to the relevant event number and press the ENTER key.
19. Move the cursor to the REPEAT #0 field and enter 1. This will cause the transient program to repeat once and thus run two times total. Do not confuse this global list level repeat capability with the list event level repeat field we skipped in step 15.
20. Make sure the output relay is closed using the OUTPUT ON/OFF key. If you start a transient program with the relay open, an error message will appear.

21. Move the cursor to the START field and press the ENTER key. The transient program you just created will execute two times. If you have an oscilloscope connected to the output, you may be able to see the output voltage change per Figure 4-40.

```

START/VIEW TRANSIENT SEQUENCE
START #0          #05= VOLTAGE SURG/SAG
PAUSE            #10= VOLTAGE SURG/SAG
REPEAT #0        #15= VOLTAGE SURG/SAG
CLEAR SEQ
PREV. SCREEN

```

Note: *The AC source output remains at the last programmed values at the completion of the list.*

In three-phase mode, the voltage lists are phase selectable. You can set up a different voltage list for each phase. To do this, use the PHASE key to choose the desired phase, as described in the example. Note that fields common to all phases such as DURATION, END DELAY and REPEAT always apply to all three phases in three-phase mode. When the cursor is moved to any of these fields, the phase enunciator in the top right-hand corner always reverts to \emptyset ABC. Frequency transients are identical to voltage transients except they apply to all three phases at all times in a three-phase configuration.

4.7.6 Programming Slew Rates

As shown in the previous examples there are a number of ways that you can generate custom waveforms. Programmable slew rates provide additional flexibility when customizing waveforms. Slew rates determine how fast the voltage or frequency is changed by the controller when a step, pulse, or list transient is triggered. Slew rates cannot be programmed from the front panel and are always set to their maximum values at power on. To use programmable slew rates, the AC source must be programmed over the bus. Refer to the SCPI Programming Manual for more information about programming slew rates.

4.7.7 Switching Waveforms

The FUNCTION field available in each transient list event setup menu may be used to dynamically switch waveforms during transient execution. This allows different waveforms to be used during transient execution. Waveforms may be switched without the output of the source being turned off. For three phase configurations, each phase has its own waveform list so different waveforms may be programmed on different phases during transient execution.

Figure 4-41 illustrates the concept of using different waveforms at different steps in a transient list. In this case, the change was programmed to occur at the zero crossing. Any phase angle can be used to start a transient step however.

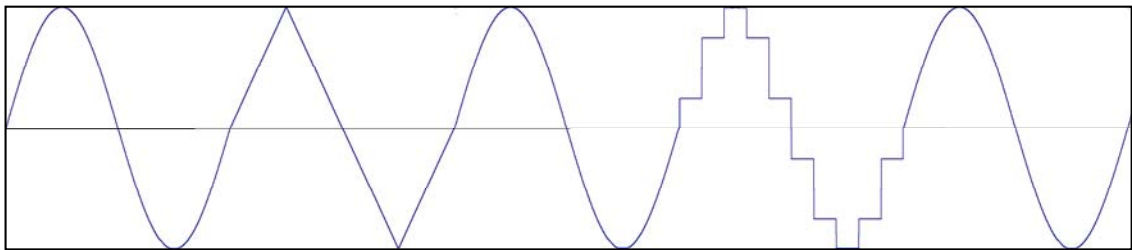

Figure 4-41: Switching waveforms in a transient list

4.7.8 Transient Execution

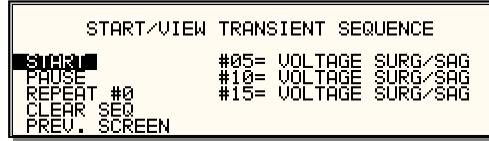

Figure 4-42: START/VIEW TRANSIENT SEQUENCE menu

A transient list can be executed from the START/VIEW TRANSIENT SEQUENCE menu. To start a transient list, position the cursor on the START field as shown in Figure 4-42 and press the ENTER key. Transients may be aborted by pressing the ENTER key again while on the same field as the field changes to ABORT while a transient execution is in progress. For short duration transients, this will likely not be visible, as the transient will complete before the screen is updated. Longer duration transients however may be aborted in this fashion.

Longer duration transients may also be suspended using the PAUSE field located below the START/ABORT field. Pressing the ENTER key while on the PAUSE field will suspend the transient execution. Once suspended, it can be resumed using the same field as the field changes to RESUME while the transient execution is suspended. Suspending a transient may be useful when running slowly changing output transients to 'hold' the output at a specific setting while observing the effect on the unit under test.

4.7.9 Saving Transient List Programs

When the AC source is turned off, the transient list that was programmed is not automatically retained. Thus, if you turn the unit off, you will lose your programmed transient list. However, transient programs may be saved in nonvolatile memory for later recall. This allows multiple transient list programs to be recalled quickly without the need to enter all parameters each time. Transient lists are stored as part of the overall instrument front panel setup in any of the available setup registers.

To save the transient list you created in the previous example, proceed as follows:

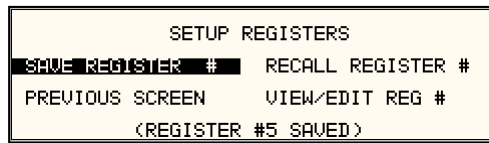

1. Press the MENU key two times to bring up the MENU 2 screen.
2. Move the cursor to the SETUP REGISTERS entry and press the ENTER key.
3. The cursor will default to the SAVE REGISTER # position. Enter a number from 0 through 15 and press the ENTER key.
4. A message will appear at the bottom of the screen indicating that the front panel settings and the transient list data have been saved in the setup register you selected.

5. Principle of Operation

5.1 General

An explanation of the circuits in the CSW5550 is given in this section. Refer to Figure 5-1 for a block diagram/ schematic and interconnect of the system.

5.2 Overall Description

Three or single phase input power is routed in from the back panel through an EMI filter and the circuit breaker to the PFC-DC/DC module. The DC outputs from the DC/DC converter is used for the Output Power Amplifier and all supplemental circuits.

The Controller assembly generates the reference waveforms and provides frequency, amplitude and phase control. The Analog Board assembly is an interface to and from the controller for all input and outputs. The assemblies are described in more detail in the following paragraphs. Refer to Figure 5-1 for an overall block diagram and System Interconnect.

5.3 Controller (A2) (7006-714)

The Controller assembly, A2, consists of one printed circuit board assembly connected by a ribbon cable. The Controller generates the waveform signal setting the frequency, amplitude and current limit level. It also senses the output voltage to provide closed loop control of the output.

In addition to the waveform generator the controller board assembly contains components for the CPU (DSP), generating the Phase waveform signals to the power amplifiers and all of the program, waveform and data memory. In addition, the Controller contains the circuits for all measurements. The clock and lock circuit required to support the clock and lock mode of operation of multiple CSW units is also on this board assembly. If the -413 option is present, a separate inter harmonic generator board is connected to the Controller board.

5.4 Keyboard/Display Board (A1) (7006-716)

The keyboard/display assembly is assembly A9. It is mounted to the front panel and holds the 23 rubber keys. It also has the LCD graphics display. A shaft encoder is mounted on the board that is used for a shuttle input.

5.5 Remote Interface (A7) (7006-715)

This board assembly is identified as A7. It has the IEEE 488, RS232 and USB transceivers and optionally an Ethernet interface (-LAN option). It also has isolators to provide safety isolation for all control interfaces. It also has a power supply that supplies isolated +5 and +3.3 supplies for all of the Remote Interface circuits.

5.6 Analog Board (A3) (5162062)

The Analog Board assembly, A3, has the following functions:

- CPLD to decode and encode the logic information to and from the Controller DSP.
- CPU to monitor the Auxiliary power sources, control the current scaling network and report to the DSP the number of power sources in the power system.
- Current Scaling network to normalize the current measurement signal for the number of power sources in the power system.
- Analog and digital interfaces for the System Interface and all direct analog and digital input and outputs.
- Isolation between the Controller and the Power Output Amplifiers.
- Error Amplifier for each of the three phase Power Output Amplifiers.
- Analog switches to steer analog signals for Master, Auxiliary, 1 and 3-phase outputs.
- Analog to TRMS digital converter for each of the three external inputs.
- Power supply steering for supplemental supplies.
- High voltage, 3-phase sense amplifier for External Voltage Sense input

5.7 Auxiliary Power Supply (A8) (5162048)

This assembly generates six low voltage outputs. These regulated outputs from the auxiliary power supply provide logic power to all the modules.

- a) +15V, 0.67A for Controller, Analog and Keyboard/ Display assemblies and indirectly for the Remote Interface assembly.
- b) -15V, 0.67A for Controller and Analog Board assemblies.
- c) +15V, 2.7A for all Output Amplifier auxiliary supplies.
- d) -15V, 0.67A for all Output Amplifier auxiliary supplies.
- e) +5V, 0.1A for all Output Amplifier auxiliary supplies.
- f) Variable 12 to 24 Vdc, 3A for both fans.

All the supplies c), d) and e) have a common ground. All other supplies have grounds that are isolated from all other supplies.

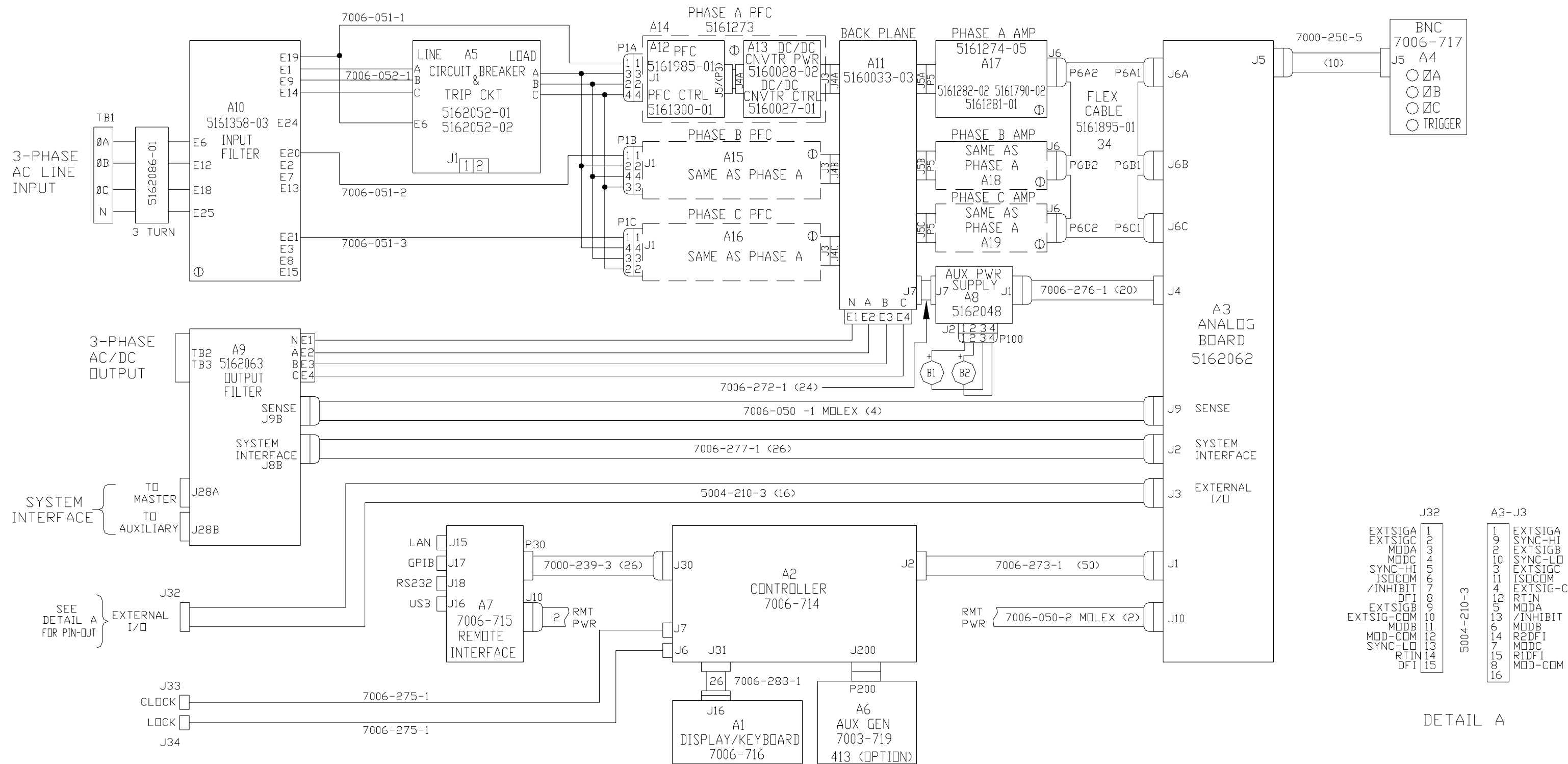

Figure 5-1: Power Source Module Block Diagram

5.8 PFC - DC/DC Module (A14, A15 and A16) (5161273)

There is one PFC–DC/DC module for each of the three phases. This module consists of a PFC and DC to DC converter assembly. One PFC-DC/DC module is associated with one output amplifier. One set is used for each output phase.

The PFC assembly controls the input power factor to be 0.99. One phase of the 3-phase AC line input is applied to the input of each module. The AC line is converted to a raw 380 Vdc bus. The bus is then delivered through a soft-start relay to the PFC circuit which consists of a boost converter. The output from the PFC is a regulated 380 Vdc bus that is delivered to the DC/ DC converter.

The DC/DC converter performs two functions. It isolates the line input from the high power DC outputs used for the output power amplifier. It generates two 290 Vdc buses for the applicable amplifier. The converter also generates an isolated 48 Vdc bus used for the power source Auxiliary Power supply. The 48 Vdc bus from each of the PFC-DC/DC modules is connected in parallel for a redundant supply.

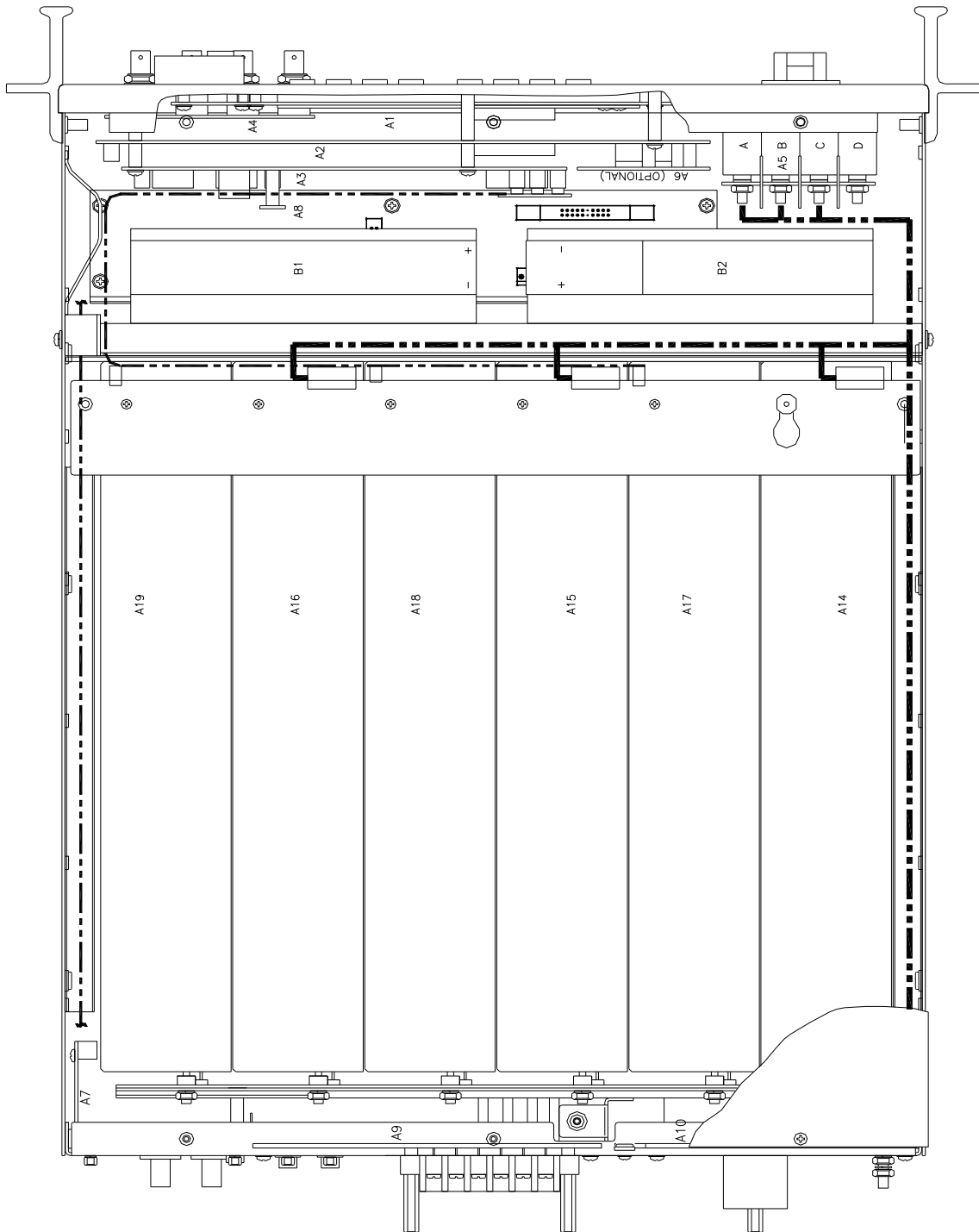

Figure 5-2: Internal Assembly Locations

5.9 Phase A, B and C Amplifiers (A17, A18, A19) (5161274-05)

The Output Phase amplifiers take the two isolated 290 Vdc supplies and generate a 156V or 312V direct coupled output. The power amplifier consists of two full bridge inverters, each inverter power with one of the 290 Vdc supplies. The two inverters are connected in parallel for the 156V range and in series for the 312V range.

The Output Amplifier assembly also contains the electro mechanical relays for isolating the output and for changing the voltage range.

5.10 Output Filter Board (A9) (5162063)

The Output Filter Board has two filter networks. One filter network reduces the output noise. The other network reduces the switching noise on the sense lines. This board assembly also holds the terminal blocks for the output power and sense lines. It also contains the two System Interface connectors.

5.11 Circuit Breaker & Trip Circuit (A5)

This assembly holds the AC line circuit breaker. This breaker is different for the 208 (5162052-02) and 400 (5162052-01) VAC line inputs.

This assembly also contains a circuit that monitors the AC line input. If the AC line input exceeds the spec limit it will trip the breaker. There is a jumper on the board assembly that must be changed between the 208 and 400 VAC levels.

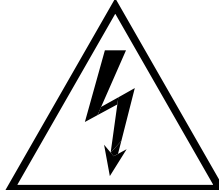

CAUTION

VOLTAGES UP TO 400 VAC AND 300 VDC ARE PRESENT IN CERTAIN SECTIONS OF THIS POWER SOURCE. THIS EQUIPMENT GENERATES POTENTIALLY LETHAL VOLTAGES.



DEATH

ON CONTACT MAY RESULT IF PERSONNEL FAIL TO OBSERVE SAFETY PRECAUTIONS. DO NOT TOUCH ELECTRONIC CIRCUITS WHEN POWER IS APPLIED.

6. Calibration

The Routine Calibration should be performed every 12 months. Non-routine Calibration is only required if a related assembly is replaced or if the periodic calibration is unsuccessful.

All standard models and configurations of the CSW555 may be calibrated using a PC running Windows 2000/XP, and the latest version of the CSWGui AC source control software. Refer to the CSWGui online help file of the CIGUISII software for additional procedures and guidance. To download the latest version of the CIGUISII, visit www.calinst.com.

6.1 Calibration Equipment

Digital Phase Meter:	Krohn-Hite, Model 6620 or equivalent. (0.01° resolution, 0.02° accuracy.)
Digital Multimeter:	Fluke 8506A or equivalent. HP 34401A
10 milliohm Current Shunt:	Isotek Model RUG-Z-R010-0.1 or equivalent
1 milliohm Current Shunt: (All multi-source power Systems)	Isotek Model RUG-Z-R001-0.1
Load Bank:	Various high power load resistors will be needed.
Computer (Optional)	PC to operate California Instruments GUI.

6.2 Calibration Screen Access

Output

To access the OUTPUT CALIBRATION screen for the first time press the MENU key twice to display the MENU 3 screen. Press the ↑ or ↓ key several times to highlight OUTPUT CAL. Press the ENTER key. Type 5000 and press the ENTER key to show the OUTPUT CALIBRATION screen.

Press the PHASE key to select the phase to be calibrated.

Measurements

To show the MEASUREMENT CALIBRATION screen follow the steps in paragraph 6.2.

Select the MEASUREMENT CAL function instead of OUTPUT CAL from the MENU 2 screen.

If another CALIBRATION screen has been accessed since power-up no password is needed. If prompted for a password, use the value 5000.

NOTE:

The Output calibration is only used to set the servo correction nominal Point. It will not affect the programmed output voltage accuracy. It is used to enhance the settling time. The Measurement Calibration is used for all programmed voltage output and current limit accuracy.

6.3 Routine Calibration

Connect the test equipment to the power source as shown in **Error! Reference source not found.**1. The AC output calibration does require an AC DVM operating with the highest accuracy. Either a Fluke 8506A or a HP 34401A may be used. If a HP 34401A is used it must be put into the slow filter mode.

6.3.1 Voltage Measurement Calibration, AC and DC

1. Program the power source and the External DMM to the AC function and 100 Hz.
2. Remove all of the output loads from the power source.
3. Connect DMM to phase A output.
4. Program the ALC OFF, the output to the AC mode, 312 volt range, 230 volts.
5. Go to the Measurement Calibration Screen. Type **5000** as the password. Press the PHASE key to select Phase A. Enter actual output (from external DMM) as the value for Phase A.
6. Repeat steps 3 through 4 for the Phase B and C outputs.
7. Program the source and External DMM to the DC function. Repeat steps 2 through 6.

6.3.2 Current Measurement Calibration, AC and DC

1. Program the power source and External DMM to the AC function.
2. Connect the load and the Current Shunt to the Phase A output as shown in Figure 6-1. Connect the Current Shunt to the Neutral output so it does not have to be moved when switching the load to the other phases. Connect the External DMM to the sense terminals of the Current Shunt.
3. Set load switches for the resistance value shown in Table 6-1 for the CSW model to be calibrated.
4. Program the output to the maximum current value, Constant Current [CC] Mode, High Voltage range, ALC OFF and 230.0 volts for all phases.
5. Go to the Current Measurement Calibration Menu. Enter the actual load current for phase A as the variable. Determine the current value from the formula; $I = V / R_{shunt}$ where V is the voltage from the shunt.
6. Repeat steps 1 through 4 for the Phase B and C outputs.
7. Program the 1-phase mode of operation. Connect the Phase A, B and C outputs together.
8. Repeat steps 1 through 4 for the 1-Phase mode of operation. Use the load value for the 1-Phase mode shown in Table 6-1.
9. Program the source and External DMM to the DC function. Repeat steps 2 through 8.

CSW Model	3-Phase Load Value	1-Phase Load Value
CSW5550	32.0 ohms	10.0 ohms
CSW11100	15.0 ohms	5.00 ohms
CSW16650	10.0 ohms	3.33 ohms
CSW22200	7.00 ohms	2.50 ohms
CSW27750	6.00 ohms	2.00 ohms
CSW33300	5.00 ohms	1.67 ohms

Table 6-1: Load Values for Output Current Calibration

6.3.3 Output Phase Calibration

1. Program the AC mode, 60 Hz, 120 volts and each Phase to the Square Wave.
2. Measure the output phase angle of phase B and C relative to phase A.
3. If the phase B and C outputs are not within ± 1 degree of the programmed phase angle, calibrate the **PHASE OFST** value in the **OUTPUT CAL** screen.

6.3.4 External Signal Input Calibration

The External Signal Input is applied to the 16-pin, D-Sub connector, J32 on the rear panel of the power source. A 0 to 5 volt signal, AC or DC, will generate a zero to full-scale output voltage, 156 or 312 volts. Refer to Table 6-2 for the connector pin connections. The A, B and C inputs will be tied together for the same input signal.

1. Connect the external AC signal to the A, B and C inputs. Use pin 10 for the common connection.
2. Program the ALC OFF and the High Voltage range. Do not close the output relays.
3. Press the MENU key to select UTILITY then VOLT/CURR CONTROL. Program VOLT REF to EXT.
4. Again press the MENU key to select EXTERNAL CALIBRATION. This screen will show four values to be calibrated:
 - a) The ZERO DC must have the value 0 entered with the **output relays open**. This value must be entered even though it already shows the zero value. Perform this operation for all three phases. This calibration must also be repeated for the RPV mode of operation. (this may change in the future since the result is the same)
 - b) FS OUT is the nominal output calibration value. This value must be between 0 and 4095. Start with a value of 1000. Close the output relays with the ALC OFF. Apply and External Input signal of 5.000 ± 0.005 volts. If necessary adjust the FS OUT value for an output of 62.4 times the exact value of the input signal. Repeat this calibration for all three phases. This procedure must also be repeated for the RPV mode but the exact same value may be programmed for the respective phase.
 - c) ZERO RMS This parameter is not used for the CSW.
 - d) FS ADC is the Full-scale calibration value. Turn OFF the ALC. Apply an External Input signal of 5.000 ± 0.005 volts. Select the phase for calibration. Enter the value of 312.0 or 62.5 times the External Signal input if it isn't exactly 5.000 volts. Repeat for all phases.

External Signal Input Function	J32 Connector Pin (Use pin 10 for the DMM common)
Phase A	1
Phase B	9
Phase C	2

Table 6-2: External Signal Input Connector Pins

6.3.5 External Gain Control (RPV)

The External Gain Control is also referred to as the RPV function. This function takes a 0 to 7.07 VDC input signal to adjust the output voltage from 0 to a full-scale output voltage, 156 or 312 Vrms. The output waveform is programmed by the internal signal generator. Follow the steps in Paragraph 6.3.4 as described below. The RPV input is applied to the same connector pins as described for the External Signal input in Paragraph 6.3.4. These connections are repeated below. The connections are made through a 16-pin, D-Sub connector, J32 on the rear panel of the power source. Refer to Table 6-2 for the connector pin connections. The A, B and C inputs will be tied together for the same input signal.

1. Connect the external AC signal to the A, B and C inputs. Use pin 10 for the common connection.
2. Program the ALC OFF and the High Voltage range. Do not close the output relays.
3. Press the MENU key to select UTILITY then VOLT/CURR CONTROL. Program VOLT REF to RPV.
4. Again press the MENU key to select EXTERNAL CALIBRATION. This screen will show four values to be calibrated:
 - a) The ZERO DC must have the value 0 entered with the **output relays open**. This value must be entered even though it already shows the zero value. Perform this operation for all three phases. This calibration must also be repeated for the RPV mode of operation.
 - b) FS OUT is the nominal output calibration value. This value must be between 0 and 4095. Start with a value of 1000. Close the output relays with the ALC OFF. Apply and External Input signal of 5.000 ± 0.005 volts. If necessary adjust the FS OUT value for an output of 62.4 times the exact value of the input signal. Repeat this calibration for all three phases. This procedure must also be repeated for the RPV mode but the exact same value may be programmed for the respective phase.
 - c) ZERO RMS This value is not used for the CSW.
 - d) FS ADC is the Full-scale calibration value. Turn OFF the ALC. Apply an External Input of 7.070 VDC ± 0.005 volts. Select the phase for calibration. Enter the value of 312.0 or 62.5 times the External input if it isn't exactly 7.070 volts. Repeat for all phases.

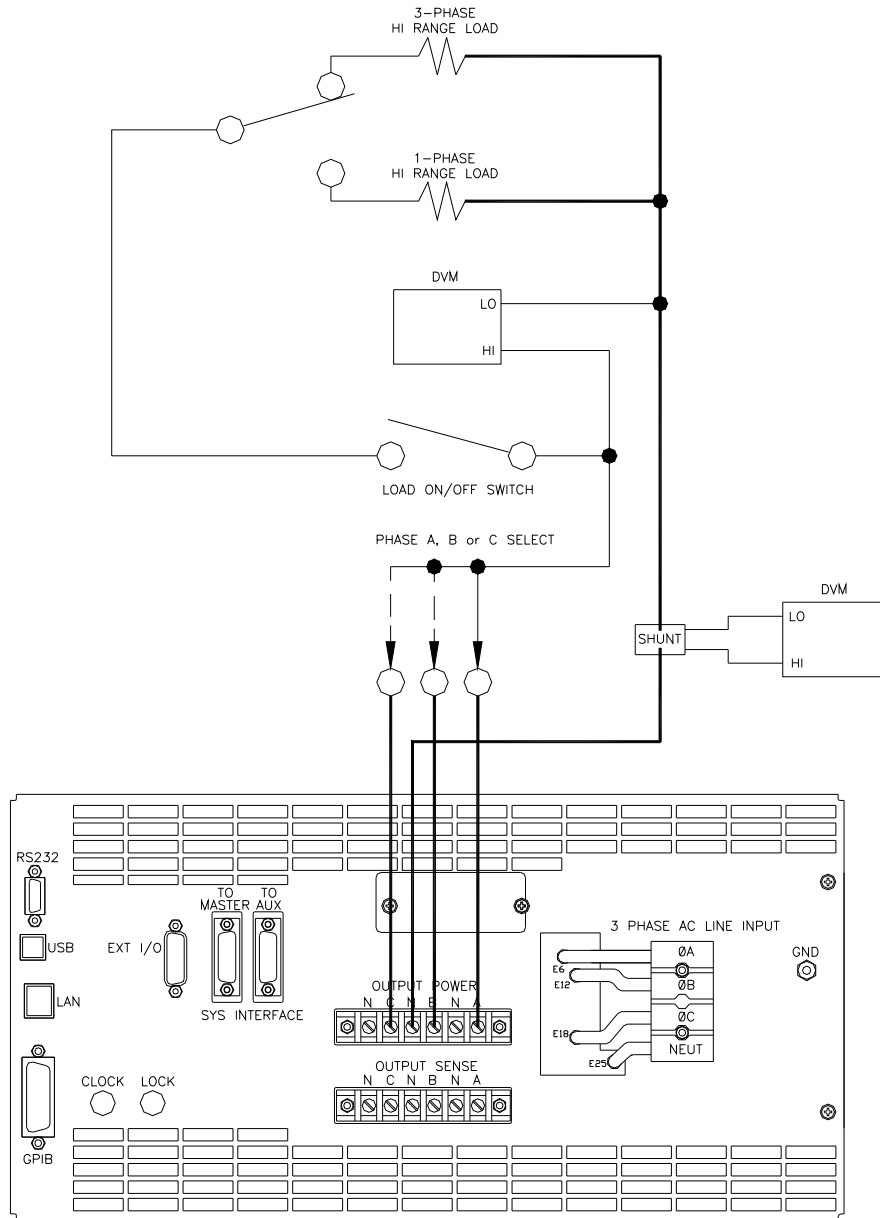

Figure 6-1: Test Equipment Hook-up for Calibration

6.4 Non-Routine Calibration

All internal adjustments are set at the factory at the time of original shipment. As such, non-routine calibration is generally not required unless one or more amplifier assemblies have been replaced in the field. In this case, perform the following sections in the order shown.

The non-routine calibration involves removing the top cover from the power source. Remove the line power from the power source before removing the top cover. All of the adjustments are on the Front Panel Assembly as shown in Figure 6-2.

6.4.1 AC Function AC Zero Adjustment (ALC can be either ON or OFF)

1. With the external DVM monitor the voltage at the power source output indicated in Table 6-3.
2. Press the PHASE key to indicate the corresponding phase to be adjusted.
3. Program the High Voltage Range, the AC function, 0.0 volts and 400 Hz.
4. Press the OUTPUT key to turn on the CSW. Perform the adjustment indicated in Table 3-1 for the indicated output phase. Make the adjustment for the lowest AC output signal. Refer to Figure 6-2 for the location of the adjustments. The external DVM should be on the 10 or 20 VAC range¹.

Output Phase	Controller Brd Adjustment	Adjustment Location
A	R229	Left
B	R230	Middle
C	R231	Right

Table 6-3 AC Zero Adjustment

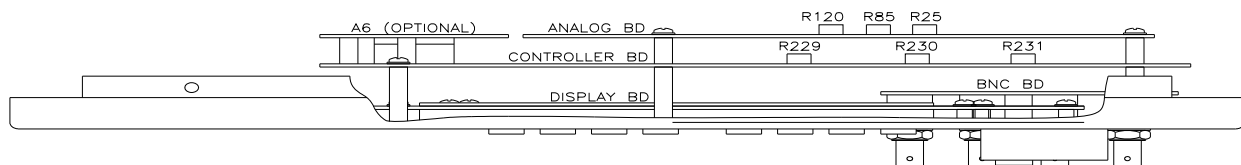

Figure 6-2: Front Panel Assembly Adjustment Location (Top View)

¹ Use the 10 or 20 VAC or VDC range to prevent an offset error in the External DVM caused by output noise.

6.4.2 AC Function DC Zero Adjustment (ALC can be ON or OFF for the following adjustments)

1. Program the External DMM to the DC function and 10 or 20 VDC range¹.
2. Program the Low Voltage Range, the AC function, 0.5 volts and 400 Hz
3. Perform the adjustment indicated in Table 6-4 on the Analog Board for the indicated output phase. Make the adjustment for the lowest DC output signal. Press the OUTPUT pushbutton to turn on the CSW. With the test station DMM set in DC mode (autoranging), verify that all output phases are 0 ± 10 mVDC. Adjust pots on the Analog Waveform Board as required to minimize DC component (Note: R25 [right] controls ϕ A, R85 [middle] controls ϕ B and R120 [left] controls ϕ C).

Output Phase	Analog Brd Adjustment	Adjustment Location
A	R25	Right
B	R85	Middle
C	R120	Left

Table 6-3: AC/DC Zero Adjustment

6.4.3 DC Function DC Zero Adjustment

1. Program the Output DC function, the High Voltage Range and enable the OUTPUT. To show the OUTPUT CALIBRATION screen for the first time, choose OUTPUT CAL from the MENU screen. Type 5000 as the password. Press the PHASE key to select the phase to be calibrated.
2. Program zero VDC and make the adjustments in the OUTPUT CALIBRATION screen with the Front Panel encoder or keypad. Adjust for ≤ 0.005 VDC.
3. Repeat step 3 for each output phase.

6.4.4 Output Adjustment:

This calibration will only affect the output voltage settling time. It sets the ALC or voltage servo to the center of its corrections range. Connect the test equipment to the power source as shown in Figure 6-1. Do not connect the load for the following adjustment. The AC output calibration does not require an AC DVM operating with the highest accuracy. The numeric value for the calibration range is from 0 to 65535.

Proceed as follows:

1. Cycle the Input Circuit breaker. Turn OFF the ALC. Program the High Voltage range and 200 volts for each phase.
2. Monitor the Phase A output voltage with the External DVM. Measure the voltage from the Phase A to the Neutral output terminals.
3. If the Phase A output voltage is not 200 ± 1 volts press the MENU key several times to display the OUTP CAL screen selection and press the ENTER key.
4. Enter the calibration password, CAL PWORD, of 5000 and press ENTER.
5. Adjust the VOLT FS for Phase A to make the external voltage 200 ± 1 volts. This must be done separately for each phase.
6. Repeat step 2 through 5 for the Phase B and C outputs.

7. Service

7.1 Cleaning

The exterior of the power source may be cleaned with a cloth dampened with a mild detergent and wrung out. Disconnect mains power to the source before cleaning. Do not spray water or other cleaning agents directly on the power source.

7.2 General

This section describes the suggested maintenance and troubleshooting procedures. The troubleshooting procedure is divided into two sections. The first section deals with basic operation and connection of the equipment. The second section requires opening the unit and using LED indicators and a simple multimeter to troubleshoot the unit down to the module level. Only a qualified electronic technician should attempt this level troubleshooting.

7.3 Basic operation

PARAGRAPH	PROBLEM
7.3.1	Excessive Output Voltage
7.3.2	Poor Output Voltage Regulation
7.3.3	Overload Light On
7.3.4	Distorted Output
7.3.5	Unit Shuts Down After 1-2 Seconds
7.3.6	No Output and no lights on front panel
7.3.7	No output, but front panel controller is active.

Table 7-1: Basic Symptoms

7.3.1 Excessive Output Voltage

CAUSE	SOLUTION
External sense not connected(If used)	Connect external sense wires from TB3 on rear panel to the AC power outlet TB2
Voltage on Output Terminal Block is higher than that on Sense Terminal Block	If the External Sense is connected to the load the voltage output on TB2 will be higher when the output is loaded
If the voltage is measured with an External DVM from Line to Line it will be higher than the programmed voltage	Connect the External DVM from Line to Neutral on the Output Sense Terminal Block, TB3) for the correct voltage.

7.3.2 Poor Output Voltage Regulation

CAUSE	SOLUTION
Unit is overloaded	Remove overload
Unit is programmed to wrong voltage range.	Select correct voltage range.
Input line has fallen below spec. limit.	Check input supply voltage.
Output Sense lines not connected to load	Connect Output Sense (TB3) to the load.

7.3.3 Overload Light is On

CAUSE	SOLUTION
Unit is overloaded	Remove overload or check CL setting
Unit is switched to high voltage range.	Select correct voltage range.
Current Limit is programmed to a value that is lower than the load current	Increase the Programmed Current Limit value.

7.3.4 Distorted Output

CAUSE	SOLUTION
Power source is grossly overloaded.	Reduce load
The crest factor of the load exceeds 3:1.	Reduce load current peaks by reducing load.

7.3.5 Unit Shuts Down after 1-2 Seconds

CAUSE	SOLUTION
Output shorted	Remove output short
Output grossly overloaded.	Remove overload.
-400 Input module failure	Have power module serviced
Operating load with too high inrush or start up currents.	Consult factory for application advice.

7.3.6 No Output and No Lights on Front Panel

CAUSE	SOLUTION
Input circuit breaker switched off.	Switch the breaker on.
No input power.	Ensure 3 phase power is present at AC input terminal block
-400 Input Power Supply failure	Have -400 input supply serviced.

7.3.7 No Output But Front Panel controller is active

CAUSE	SOLUTION
“OUTPUT ON” button is turned off.	Press OUTPUT ON so that “ON” LED is lit.
Current limit programmed down or to zero.	Program current limit higher.
Voltage programmed down or to zero.	Program the correct output voltage
Voltage programmed to the wrong output	Program the correct output phase
There is an output on at least one output but not on the other outputs	Check the 3-phase AC line input. If there is one phase of the AC line input missing one or more outputs will be missing.
REMOTE SHUTDOWN logic line at J32 pin 7 is shorted to D COM or A COM.	Remove connection from J32 pin 7.
Voltage programmed down or to zero.	Program a higher output voltage.

7.3.8 Distorted Output

CAUSE	SOLUTION
Power source is grossly overloaded.	Reduce load
The crest factor of the load exceeds 3:1 on the low range or 5:1 on the high range.	Reduce load current peaks by reducing load.

7.3.9 No Output and No Lights on Front Panel

CAUSE	SOLUTION
Input circuit breaker switched off.	Switch the breaker on.
No AC Line input power to TB1.	Ensure 3 phase power is getting to TB1.
Circuit Breaker tripped for overvoltage or over current.	Turn circuit breaker off - wait five seconds - turn circuit breaker back on. If breaker trips again measure the AC line input

8. Top Assembly Replaceable Parts

<u>Top Assy.</u>	<u>Model</u>
7006-404-2	CSW5550, 400 VAC INPUT
7006-404-1	CSW5550, 208 VAC INPUT

8.1 Sub assemblies

#	CI PART #	DESCRIPTION	VENDOR	QTY
	7006-405-1	Front Panel Assembly (A1, A2, A3 and A4)	CI	1
A1	7006-716-1	Display/ Keyboard Assembly	CI	1
A2	7006-714-1	Controller Assembly	CI	1
A3	5162062-01	Analog Board Assembly	CI	1
A4	7006-717-1	BNC Board Assembly	CI	1
A5	5162052-01	Circuit Breaker & Trip for 400V	CI	1
A5	5162052-02	Circuit Breaker & Trip for 208V	CI	1
A7	7006-715-1	Remote Interface Assembly	CI	1
A7	7006-715-2	Remote Interface Assembly with LAN	CI	1
A14-A16	516273-03	PFC Module Assembly for 208 VAC Line Input	CI	3
A14-A16	516273-04	PFC Module Assembly for 400 VAC Line Input	CI	3
A17-A19	5161274-05	Amplifier Module Assembly		
B1, B2	241183	FAN 6 INCH--JD24B2	Rotron	2

Table 8-1: Replaceable Parts

9. Options

9.1 RTCA/DO-160 Option

The RTCA/DO-160 Option is made up of both firmware that resides in the power source and the CSWGui Windows application program. The firmware covers revision D, and the GUI covers revision E.

The user interface for each implementation is different however. The revision D tests can be operated directly from the power source's front panel or through the supplied GUI program. The Revision E tests can only be operated through the GUI windows software. Thus, for Rev E use, a Windows PC and interface is required.

Section 9.1.1 covers operation of the firmware based revision D tests.

For information regarding the operation of the DO160 revision E tests with the CSWGui, please refer to the Avionics Software Manual (CI part no. 4994-971 included on CDROM). Note that future updates of the CSWGui may include overlapping coverage for revision D in the software as the CSWGui program is designed to support all revisions. For now, revision D has no associated data files in the CSWGui but does have its own unique interface control screen.

9.1.1 Option –160: RTCA/DO160 rev D Tests (Firmware)

9.1.1.1 General

The RTCA/DO-160D option is capable of performing all sections of RTCA/DO-160D, Section 16 and EUROCAE-14D / RTCA DO160D, Section 16 for the AC Source signal. A selection is made available to specify the type of standard, and groups.

Throughout this document, Groups 1 through 3 will be used to refer to EUROCAE-14D standard.

9.1.1.2 Initial Setup

Nominal parameters for the AC Power source are as follows:

Output Voltage	115V L-N or 230V L-N
Output Frequency	360 Hz to 800 Hz

Nominal parameters for the DC Power source are as follows:

Output Voltage	28V or 14V L-N
----------------	----------------

A setting outside these nominal values will disable the test and will prevent accessing to its Menu screens. To access the test for the 230V L-N, the power source must be capable of programming 360V.

9.1.1.3 Tests Performed

9.1.1.3.1 NORMAL STATE**AC Source:**

1. Normal State Voltage and Frequency test
2. Voltage unbalance test
3. Waveform Distortion test
4. Voltage Modulation test
5. Frequency Modulation test
6. Momentary Power Interrupt (Under voltage) test
7. Voltage Surge (Overvoltage) test
8. Frequency Transients test(Group 1 only)
Frequency Variation test (Group 2 and 3 only)

DC Source:

1. Normal State Voltage test
2. Momentary Power Interrupt (Under voltage) test
3. Voltage Surge and Under

9.1.1.3.2 EMERGENCY TEST**AC Source:**

1. Emergency Voltage and Frequency minimum
2. Emergency Voltage and Frequency maximum
3. Voltage unbalance

DC Source:

1. Emergency Voltage

9.1.1.3.3 ABNORMAL TEST**AC Source:**

1. Abnormal Voltage minimum
2. Abnormal Voltage maximum
3. Voltage Drop
4. Voltage Surge
5. Frequency Transients test (group 1 only)

DC Source:

1. Abnormal Voltage minimum
2. Abnormal Voltage maximum
3. Abnormal Voltage low
4. Voltage Drop
5. Voltage Surge

9.1.1.4 Front Panel Entry

To perform a test from the keyboard, from the MENU 2 screen, select the APPLICATIONS screen. The APPLICATIONS screen will appear as shown in Figure 9-1.



Figure 9-1: Application Menu

Scroll to the RTCA/DO-160D entry using the up and down cursor keys. Press the ENTER key to select the RTCA/DO 160D main menu. The screen will appear as shown in Figure 9-2.

Note: The user has to turn on the Output relay before starting a test.

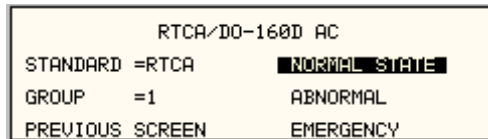

Figure 9-2: DO160 Main Menu

9.1.1.5 AC TESTS

Note: Prior to test selection the standard and the group selection are required. Use the shuttle to select the standard and the group if applicable.

9.1.1.5.1 Normal state test

Scroll to the NORMAL STATE AC entry using the up and down cursor keys. Press the ENTER key to select the NORMAL STATE screens. The screen will appear as shown in Figure 9-3.



Figure 9-3: Normal state

The DO160 NORMAL 1 and NORMAL 2 screens have the following tests:

- 1 VOLT FREQ MIN
- 2 VOLT FREQ MAX
- 3 VOLT UNBALANCE
- 4 WAVEFORM DISTORTION
- 5 VOLT MODULATION
- 6 FREQ MODULATION
- 7 POWER INTERRUPT
- 8 VOLTAGE SURGE
- 9 FREQ TRANSIENT (group 1)
FREQ VARIATION (group 2 & 3)

The above tests can be selected by scrolling to the highlighted selection using the up and down key and the ENTER key to start the selected test. For some of these tests, numeric data entry may be required to define the test number or the modulation rate.

VOLT FREQ MIN

Standard/Group		RTCA	Group1	Group2	Group3
Voltage	1	100	104	104	104
	3	101.5	105.5	105.5	105.5
Frequency		380	390	360	360

Table 9-1: Normal Voltage and Frequency minimum

Standard/Group		RTCA	Group1	Group2	Group3
Voltage	1	122	122	122	122
	3	120.5	120.5	120.5	120.5
Frequency		420	410	650	800

Table 9-2: Normal Voltage and Frequency Maximum

This test will set the voltage and frequency to levels defined by Table 9-1. The test will last for 30 minutes. The test will be repeated for the Group 2 and 3 using the Voltage setting from Table 9-2 and the frequency from Table 9-1. The ← key (backspace) will terminate the test at any time.

VOLT FREQ MAX

This test will set the voltage and frequency to levels defined by Table 9-2. The test will last for 30 minutes. The test will be repeated for the EURO standard using the Voltage setting from Table 9-1 and the frequency from Table 9-2. The CLR Key in local operation will terminate the test at any time. Group execute trigger will terminate the test remotely. The unselected phases will remain at 115 volts. The ← key (backspace) will terminate the test at any time.

VOLT UNBALANCE

Standard/Group	RTCA	Group1	Group2	Group3
Voltage offset	6	6	6	9
Frequency	400	400	360/650	360/800

Table 9-3: Normal Voltage Unbalance

This test will change the output voltage for each phase from 115 volts to 115V + offset. Refer to Table 9-3 for the offset value and the Frequency. The test will last 30 minutes. The test will be repeated for a second Frequency if applicable. The test can be terminated at any time. The ← key will terminate the test at any time.

WAVEFORM DISTORTION

This test will generate a 5% THD voltage distortion on the output voltage waveform. The distortion is generated by using a clipped sine wave. The test will last for 30 minutes. The ← key (backspace) will terminate the test at any time.

VOLTAGE MODULATION

This test requires a numeric value entry equal to the modulation rate in Hz. This entry value must be between 1 Hz and 200 Hz. The amplitude modulation is calculated based on the modulation rate as defined in Figure 9-4. This test will last for 2 minutes.

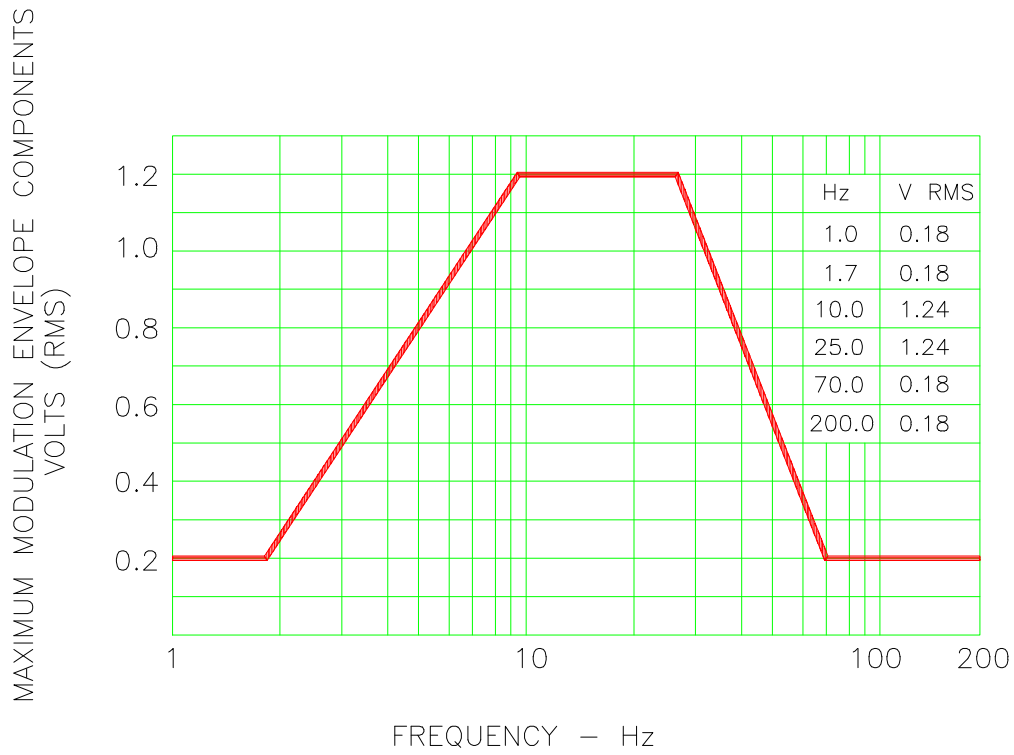

FREQUENCY CHARACTERISTICS OF AC VOLTAGE MODULATION ENVELOPE

Figure 9-4: Voltage Modulation

FREQUENCY MODULATION

This test requires a numeric value equal to the modulation rate in Hz. This value must be between 0.01 Hz and 100 Hz. The frequency modulation is calculated based on the modulation rate as defined in Figure 9-5. This test will last for a minimum of 2 minutes.

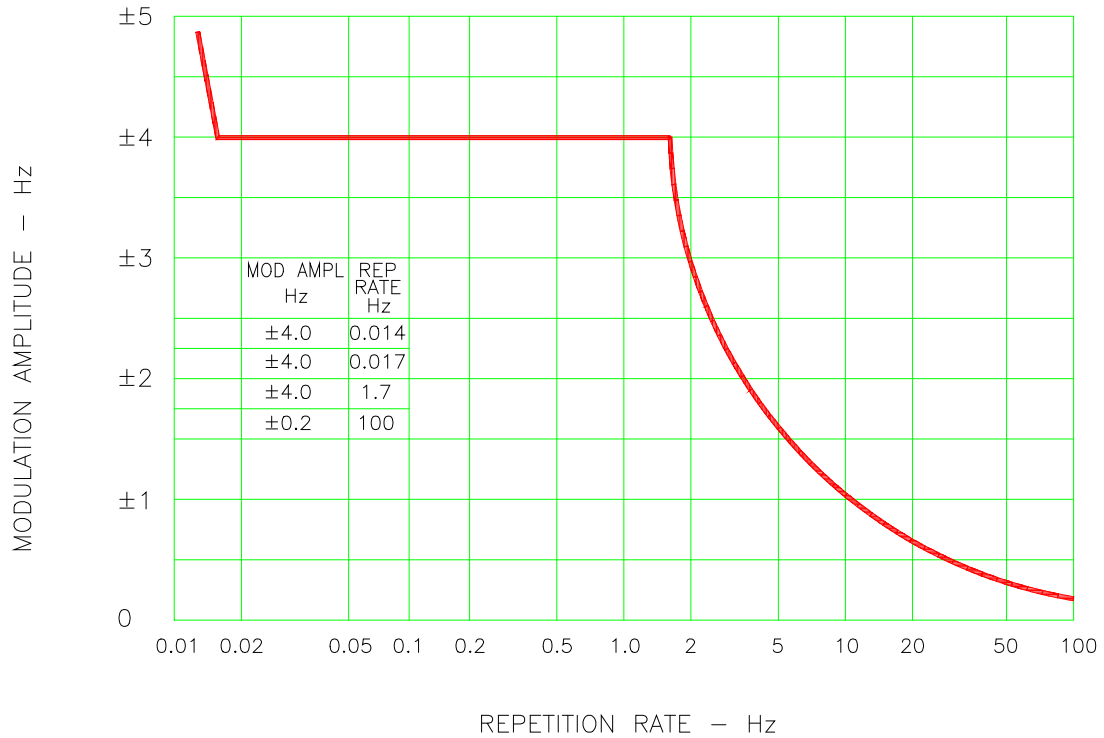

CHARTACTERISTICS OF AC FREQUENCY MODULATION

Figure 9-5: Frequency Modulation

POWER INTERRUPT

This test requires a numeric entry value equal to the test number. The tests are grouped as follows:

- Test numbers 1 through 15 are for all Standard and Groups. See Figure 9-6 for details of the tests.
- Test numbers 16 and 17 for all equipment that does not incorporate digital circuit. Test number 16 will drop the output to zero voltage for 50 ms. Test number 17 will drop the output to zero voltage for 200 ms. Test number 18 is used for DC equipment and will drop the output for 1 sec.
- Test numbers 21 through 26 are applicable for Groups 2 and 3 only. Output frequency will be set to the F1 value for 1 second prior to the test. The output frequency will remain set to the F2 value when the test is completed. This will allow the user to apply sequence of power interrupts. See Figure 9-7 for detail of the tests.

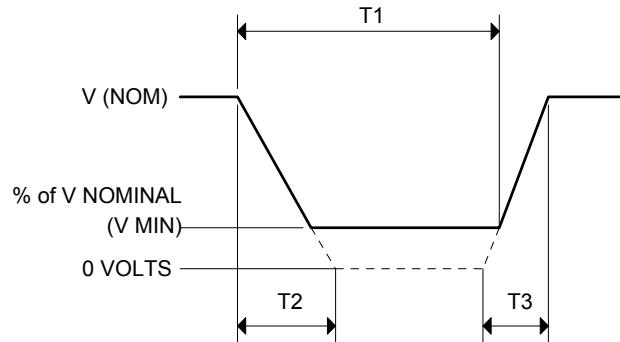

DO160 Table 16-1: Test conditions for equipment with digital circuits.

- NOTES
- 1: Definitions:
 T1 Power interrupt time
 T2 Time it would take for the applied voltage to decay from V (nom) to zero volts.
 T3 Time it would take for the applied voltage to rise from zero to V (nom) volts.
 V MIN The minimum level (expressed as a percentage of V NOMINAL) to which the applied voltage is permitted to decay.
 - 2: Tolerance to T1, T2, T3 = ± 10%
 - 3: Test condition numbers 8 and 15 are for category Z, dc powered equipment only.

Applicable Category:	A				A, Z			Z	A, B, Z			A, Z		Z	
	1**	2	3	4	5	6	7	8	9	10	11	12	13	14	15
T1 (ms)	2**	10	25	50	75	100	200	1000	10	25	50	75	100	200	1000
T2 (ms)	<1	20*	20	20	20	20	20	20	50*	50*	50	50	50	50	50
T3 (ms)	<1	5	5	5	5	5	5	5	20	20	20	20	20	20	20
%V Nom. (V min)	0	50	15	10	5	0	0	0	80	50	0	15	5	0	0

* Voltage will not reach zero in this test condition.

** Equipment performance standards may require repeating test n°1 with T1 varying from 5 to 200 ms by step defined in the test equipment performance standards (step typically comprised between 5 ms and 20 ms depending on equipment design).

Figure 9-6: Power Interrupt

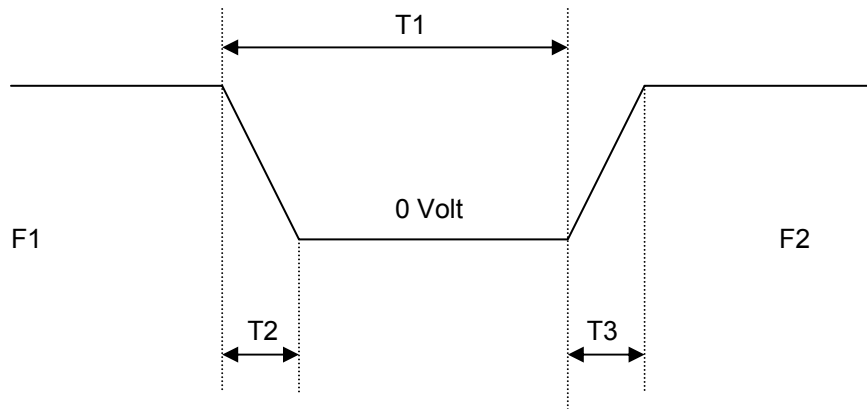

Test no.	21(I)	22(II)	23(III)	24(IV)	25(V)	26(VI)
T1 (ms)	50	50	100	100	200	200
F1 (Hz)	360	Fmax	360	Fmax	360	Fmax
F2 (Hz)	Fmax	360	Fmax	360	Fmax	360

Fmax = 650 Hz for Group 2
 Fmax = 800 Hz for Group 3
 T2 = 20 msec
 T3 = 5 msec

Figure 9-7: Power Interrupt for Group 2 and 3

VOLTAGE SURGE

This test requires 160 volts output. If the power source is set at the low voltage range, the high voltage range will be selected before the test starts. At the end of the test, the power source will be switched back to the low range automatically

Seq. No.	Voltage				Time
	RTCA	Group 1	Group 2	Group 3	ALL
1	115	115	115	115	5 Minute
2	160	160	160	170	30msec
3	115	115	115	115	5 Sec.
4	60	70	70	70	30msec
5	115	115	115	115	5 Sec.

Table 9-4: Normal VoltageSurge Sequence

The output voltage will follow the sequence in Table 9-4. The above sequence will repeat itself three times. Each repeat will start from sequence two. US and Group 1 will run at 400 Hz. Group 2 and Group 3 will run at 360 Hz and 650 Hz for Group 2 and 800 Hz for Group 3. The frequency will return to the nominal setting when the test is completed. The ← key (backspace) will terminate the test at any time.

FREQUENCY TRANSIENTS (Group 1 only)

Seq. No	Frequency	Time
1	400	5 Minute
2	440	150msec
3	400	5Sec.
4	350	150msec
5	400	5Sec.

Table 9-5: Normal Frequency Transient Sequence

This test applies to Group 1 only. At 115 voltage, change the frequency per sequence listed in Table 9-5. The test will cycle 5 times starting from sequence 2.

FREQUENCY VARIATION (Group 2 and 3 only)

Seq. No	Initial Frequency		Slew rate Hz/Sec	Final Frequency	
	Group2	Group3		Group2	Group3
1	360	360	100	650	800
2	650	800	100	360	360
3	360	360	Pause 5 sec	360	360

Table 9-6: Normal Frequency Variation Sequence

This test will apply to Group 2 and 3 only. At 115 voltage, the frequency is set to 360Hz for 5 minutes. The frequency is slowed per sequence listed in Table 9-6. The test will cycle 3 times. The frequency will return to nominal after the test is completed.

9.1.1.5.2 EMERGENCY TEST

From the DO160 MENU scroll to the EMERGENCY AC entry using the up and down cursor keys. Press the ENTER key to select the EMERGENCY screens. The screen will appear as shown in Figure 9-8.

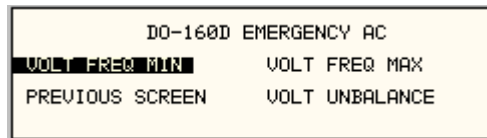

Figure 9-8: Emergency Screen

The EMERGENCY SCREEN has the following tests:

- 1 VOLT FREQ MIN
- 2 VOLT FREQ MAX
- 3 VOLT UNBALANCE

The above tests can be selected by scrolling to the highlighted selection using the up and down key and the ENTER key to start the selected test.

VOLT FREQ MIN

Standard/Group		RTCA	Group1	Group2	Group3
Voltage	1 Φ	100	104	104	104
	3 Φ	101.5	105.5	105.5	105.5
Frequency		360	360	360	360

Table 9-7: Emergency Voltage and Frequency Minimum

Standard/Group		RTCA	Group1	Group2	Group3
Voltage	1 Φ	122	122	122	122
	3 Φ	120.5	120.5	120.5	120.5
Frequency		440	440	650	800

Table 9-8: Emergency Voltage and Frequency Maximum

This test will set the voltage and frequency for a level defined by Table 9-7. The test will last for 30 minutes. The test will be repeated using the voltage from Table 9-8 and frequency from Table 9-7. The ← key (backspace) will terminate the test at any time.

VOLT FREQ MAX

This test will set the voltage and frequency for a level defined by Table 9-8. The test will last for 30 minutes. The test will be repeated using the voltage from Table 9-7 and frequency from Table 9-8. The ← key (backspace) will terminate the test at any time.

VOLT UNBALANCE

Standard/Group	RTCA	Group1	Group2	Group3
Voltage offset	8	8	8	12
Frequency	400	400	360/650	360/800

Table 9-9: Emergency Voltage Unbalance

This test will change the output voltage for each phase from 115 volts to 115V + offset. Refer to Table 9-9 for the offset value and the Frequency. The test will last 30 minutes. The test will be repeated for a second Frequency if applicable. The ← key (backspace) will terminate the test at any time.

9.1.1.5.3 ABNORMAL TEST

From the DO160 MENU Scroll to the ABNORMAL AC entry using the up and down cursor keys. Press the ENTER key to select the ABNORMAL screens. The screen will appear as shown in Figure 9-9.

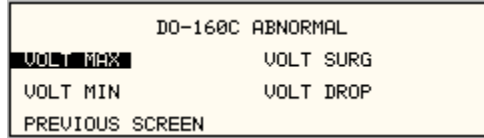

Figure 9-9: Abnormal Screen

The ABNORMAL SCREEN has the following tests:

- 1 VOLT MAX
- 2 VOLT MIN
- 3 VOLT SURG
- 4 VOLT DROP
- 5 FREQ TRANSIENTS

The above test can be selected by scrolling to the highlighted selection using the up and down key and the ENTER key to start the selected test.

VOLT MAX

Standard/Group		RTCA	Group1		Group2	Group3
Voltage	1	97	97	104	97	97
	3	98.5	98.5	105.5	98.5	98.5
Frequency		400	400	370	360	360

Table 9-10: Abnormal Voltage Minimum

Standard/Group		RTCA	Group1		Group2	Group3
Voltage	1	134	134	122	134	134
	3	120.5	132.5	120.5	132.5	132.5
Frequency		400	400	430	650	800

Table 9-11: Abnormal Voltage Maximum

This test will set the voltage and frequency to levels defined by Figure 9-10 for 5 minutes. The test will be repeated for Group1 only as indicated in Table 9-10 for voltage and Table 9-11 for frequency. All Groups will repeat the test using Table 9-10 for the voltage setting and Table 9-10 or Table 9-11 for the frequency setting. The ← key (backspace) will terminate the test at any time.

VOLT MIN

This test will set the voltage and frequency to levels defined by Table 9-11 for 5 minutes. The test will be repeated for Group1 only as indicated in Table 9-11. All Groups will repeat the test using Table 9-11 for the voltage setting and Table 9-10 for the frequency setting. The ← key (backspace) will terminate the test at any time.

VOLT UNDER

This test will drop the output voltage from 115 volts to 60 volts for 7 seconds.

VOLT SURGE

This test requires 180 volts output. If the power source is set at the low voltage range, the high voltage range will be selected before the test starts. At the end of the test the AC source will be switched back to the low range.

The output voltage will surge to 180 volts for 100 ms. followed by drop to 148 volts for 1 sec before it returns to 115 volts. The ← key (backspace) will terminate the test at any time.

FREQUENCY TRANSIENTS (Group 1 only)

Seq. No.	Frequency	Time
1	400	5 minutes
2	480	5 sec.
3	400	10 sec.
4	320	5 sec.
5	400	10 sec.

Table 9-12: Abnormal Frequency Transient

This test will set the voltage at 115V and will remain at this voltage throughout the test. The test will cycle the frequency three times as shown in Table 9-12. Each repeat will start from sequence 2.

9.1.1.6 DC TESTS

If the output voltage is set for 24V DC or 14V DC the DO-160 DC Main selection screen will appear as seen in Figure 9-10.

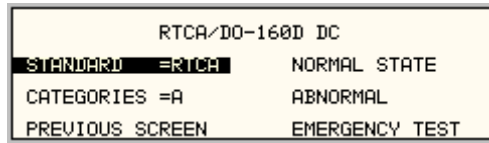

Figure 9-10: DO-160 DC Main Menu

Note: Prior to test selection the Standard selection and Category selection are required. Use the shuttle to select Standard RTCA or EUROCAE. Also, select equipment category A, B or Z.

9.1.1.6.1 Normal State Test

Scroll to the NORMAL STATE entry using the up and down cursor keys. Press the ENTER key to select the NORMAL STATE screen. The screen will appear as shown in Figure 9-11.

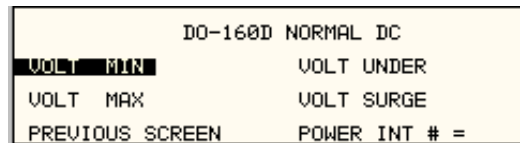

Figure 9-11: Normal State

The DO-160 NORMAL screen has the following tests:

1. VOLT MIN
2. VOLT MAX
3. VOLT UNDER
4. VOLT SURGE
5. POWER INTERRUPT

The above tests can be selected by scrolling to the highlighted selection using the up and down key and the ENTER key to start the selected test. For some of these tests, numeric data entry may be required to define the test number or the modulation rate.

VOLT MIN

Standard	Categories		
	A and Z	B 28V / 14V	
RTCA	22.0	22.0	11.0
EUROCAE	22.0	25.1	12.5

Table 9-13: Normal Voltage Minimum

This test will change the output voltage from 28V or 14V to 22V or 11V. The test will last for 30 minutes. The ← (backspace) will terminate the test at any time.

VOLT MAX

Standard	Categories		
	A and Z	B 28V / 14V	
RTCA	30.3	30.3	15.1
EUROCAE	30.3	29.3	14.6

Table 9-14: Normal Voltage Maximum

This test will change the output voltage from 28V or 14V to 30.3V or 15.1V. The test will last for 30 minutes. The ← (backspace) will terminate the test at any time.

VOLT UNDER

This test applies to category Z and 28 volt category B equipment. The output voltage will drop to 10 volts and will ramp up at a rate of 0.15 volt/sec for the US standard and at a rate of 0.30 volt/sec for EUROCAE standard for 30 seconds before it returns to nominal value.

VOLT SURGE

This test will surge and sag the voltage to a level and duration specified Table 9-15 with 5 seconds between transients. The test is repeated three times.

Category	Surge			Sags		
	Volt		Dwell(msec)	Volt		Dwell(msec)
	RTCA	EUR		US	EUR	
A	40	40	30	15	17	30
B	40	40	30	15	17	30
Z	50	50	50	12	12	30

Table 9-15: Voltage Surge

POWER INTERRUPT

Refer to section POWER INTERRUPT.

9.1.1.6.2 Abnormal Test

From the DO-160 MENU scroll to the ABNORMAL DC entry using the up and down cursor keys. Press the ENTER key to select the ABNORMAL screen. The screen will appear as shown Figure 9-12.

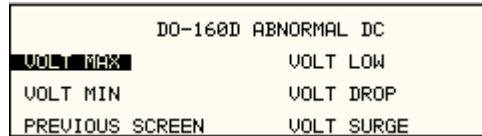

Figure 9-12: Abnormal State

The Abnormal Test has the following tests:

1. VOLT MIN
2. VOLT MAX
3. VOLT LOW
4. VOLT DROP
5. VOLT SURGE

The above tests can be selected by scrolling to the highlighted selection using the up and down key and the ENTER key to start the selected test.

VOLT MIN

This test will change the output voltage from 28V or 14V to 20.5V or 10V. The test will last for 30 minutes. The ← key (backspace) will terminate the test at any time.

VOLT MAX

This test will change the output voltage from 28V or 14V to 32.2V or 16V. The test will last for 30 minutes. The ← key (backspace) will terminate the test at any time.

VOLT LOW

This test applies for category B equipment.

This test will change the output voltage to the voltage minimum for one minute. The voltage will decay linearly to zero voltage in a ten minute period before returning to its nominal voltage.

VOLT DROP

This test will change the output to 12V from 28V or to 6V from 14V for seven seconds. The output voltage will return to nominal voltage after seven seconds.

VOLT SURGE

This test will produce voltage surge defined by Table 9-16. This test will be repeated three times with ten seconds intervals. The voltage values are halved for 14.0V category B equipment.

Category	Surge 1		Surge 2	
	Volt	Dwell(msec)	Volt	Dwell(msec)
A	46.3	100	37.8	1000
B	60	100	40	1000
Z	80	100	48	1000

Table 9-16: Abnormal Voltage Surge

9.1.1.6.3 Emergency Test

The Emergency test is selected from the DO-160 DC Main Menu. This test will set the output voltage to 18V for 28V equipment and to 9V for 14V equipment. The test will last for 30 minutes. The ← key (backspace) will terminate the test at any time.

9.2 IEC 61000-4-11 Option

9.2.1 General

The IEC1000-4-11 option is capable of performing IEC1000-4 section 11 voltage dips, short interruptions and voltage variations immunity tests. On three-phase CSW Configurations, the user can select one, two or all three phases to be active during the IEC1000-4-11 tests in this configuration.

9.2.2 Standard Revisions and EUT Classes

The -411 option supports both the first (1994-06) and the second edition (2004-03) of the IEC 61000-4-11 test standard. The desired standard revision can be selected when using the GUI Windows program. From the front panel, there is no need to select the revision but data values can be set that support either version of the standard.

Generic tests files are distributed with the GUI program for both editions of the test standard. Files applicable to Edition 2.0 have ED20 in their file name. Do not mix these files, as the data setup will not be correct if you do. To load a test file, select the Mode (Dips or Vars) and test standard revision first, then use the File, Open menu to load the test parameters. Test parameters can be a function of the EUT class. The different files provided with the program cover the various EUT classes. The relevant EUT class 1, 2, 3 or X is listed in the file names.

When using front panel operation, the user has to set levels for each individual test step in SINGLE mode.

9.2.3 Initial Setup

The user must set the operating frequency and voltage and close the output relay prior to the start of test. It is possible to change the normal voltage (U_t) from the IEC1000-4-11 menus before running each test. To run any IEC 61000-4-11 test, the IEC411 state must be turned on. If an EOS1 or EOS3 is detected, it will be put in ACTIVE mode as long as the IEC411 state is ON.

9.2.4 Phase Selection

On three phase power source models, phase selection for individually executed dips or the preset RUN ALL selection can be made using the PHASE key on the front panel. The phase or phases selected will be displayed in the upper right hand corner of the LCD as either A, B, C, AB, AC, BC or ABD.

With the introduction of Edition 2.0, three phase voltage dips testing has been redefined for both Wye and Delta loads.

For Star (Wye) connected three-phase EUT's, voltage dips should be performed on both individual Line-to-Neutral voltages as well as on all three Line-to-Line voltages. Thus, each test should be run 6 times, each time selecting a different phase option: A, B, C, A+B, A+C and B+C.

For Delta connected three-phase EUT's, voltage dips, only Line-to-Line voltages dips have to be run. Thus, each test can be run 3 times, each time selecting a different phase A+B, A+C and B+C.

Note that the -411 option in CSW Series AC sources with Firmware revision lower than 2.38 will not support 2 phase out of 3 selections. CSW Series I systems with firmware revision 3.04 or higher and CSW Series II systems with firmware revision 4.17 or higher support three phase dips testing using the preferred method referenced in figure 4b) (A) of IEC 61000-4-11, Edition 2.0. CSW units with revisions prior to this will change the L-N amplitude by the set dip level but

retain the normally programmed phase angle relationship. For firmware upgrades, contact support@calinst.com.

Note that required phase angles and amplitudes are automatically set for dips of 0, 40, 70, 80 and 100% to conform with method (A). For all other dip levels, method (A) can be used by programming the required phase angles to be used during the programmed dips. The amplitude and phase angles required to obtain the correct line-to-line voltage dip per method (A) for standard dip levels of 40, 70 and 80% are embedded in the firmware and conform to table C.2 of IEC 61000-4-34.

Since all phase programming on the CSW series is referenced to phase A, voltage dip with a phase angle for A other than 0° are implemented by offsetting all three phases by the required number of degrees to get phase A at 0°. This is reflected in the actual output settings shown on the CSW versus the data in table C.2 of the IEC61000-4-34. The actual output settings are shown in the last 3 columns.

Phase Mapping

The phase rotation on the CSW series is ACB. This means phase A is mapped to L1, phase B is mapped to L3 and phase C is mapped to L2. The required phase selection letter combination for the required Line-to-line dip is shown in table C.2 for reference.

IEC Tables	CSW Reference
L1	A
L2	C
L3	B

Table 9-17: Phase mapping

To select the desired phase-to-phase dip, select the phase selection as shown in column 8 and either 80, 70 or 40 % dip level from the IEC411 screen or the Gui. Table C.2

	Line to Line			Line to Neutral			Phase Selection	CSW Setting		
	L1-L2	L2-L3	L3-L1	L1-N	L2-N	L3-N		A-N	C-N	B-N
100% dip (no dip)	100 % 150°	100 % 270°	100 % 30°	100 % 0°	100 % 120°	100 % 240°	n/a	100 % 0°	100 % 120°	100 % 240°
80% dip L1-L2	80% 150°	100% 270°	92% 41°	72% 14°	100% 120°	100% 240°	AC	72% 0°	100% 106°	100% 226°
80% dip L2-L3	92% 161°	80% 270°	100% 30°	100% 0°	72% 134°	230 240°	BC	100% 0°	72% 134°	100% 240°
80% dip L1-L3	100% 150°	92% 281°	80% 30°	100% 0°	100% 120°	72% 254°	AB	100% 0°	100% 120°	72% 254°
70% dip L1-L2	70% 150°	100% 270°	89% 47°	61% 25°	100% 120°	100% 240°	AC	61% 0°	100% 95°	100% 215°
70% dip L2-L3	89% 167°	70% 270°	100% 30°	100% 0°	61% 145°	100% 240°	BC	100% 0°	61% 145°	100% 240°
70% dip L1-L3	100% 150°	89% 287°	70% 30°	100% 0°	100% 120°	61% 265°	AB	100% 0°	100% 120°	61% 265°
40% dip L1-L2	40% 150°	100% 270°	87% 67°	53% 79°	100% 120°	100% 240°	AC	53% 0°	100% 41°	100% 161°
40% dip L2-L3	87% 187°	40% 270°	100% 30°	100% 0°	53% 199°	100% 240°	BC	100% 0°	53% 199°	100% 240°
40% dip L1-L3	100% 150°	87% 307°	40% 30°	100% 0°	100% 120°	53% 319°	AB	100% 0°	100% 120°	53% 319°

Table 9-18: IEC 61000-3-34 Table C.2

Other Dip levels for 2 phase selections.

Note that any other dip level not listed in this table will result in voltage dips conform method (B) so both phases will dip by the actual dip percentage set.

To implement user defined three phase dips other than those listed in this table, the IEC411 phase setting for phases A, B and C may be used to set the desired phase angle for each dips. This setting is ignored if the dip levels is set to 80, 70 or 40 but otherwise controls the phase angle of the selected phase during the dip.

9.2.5 Tests Performed

DIPS AND INTERRUPTIONS

- | | |
|---------------|-----------------------------------|
| 1. Run All | Run predefined sequence of tests. |
| 2. Run Single | Run user defined test. |

VOLTAGE VARIATIONS

- | | |
|---------------|-----------------------------------|
| 1. Run All | Run predefined sequence of tests. |
| 2. Run Single | Run user defined test. |

9.2.6 Front Panel Entry

To perform a test from the keyboard, select the APPLICATIONS screen from the MENU 2 screen. The APPLICATIONS screen will appear as shown in Figure 9-13



Figure 9-13: Application menu

Scroll to the IEC 1000-4-11 entry using the up and down cursor keys. Press the ENTER key to select the IEC 1000-4-11 main menu. The screen will appear as shown in Figure 9-14.

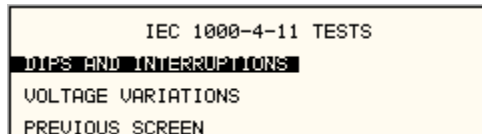

Figure 9-14: IEC1000-4-11 Menu

9.2.6.1 DIPS AND INTERRUPTIONS TEST

Scroll to the DIPS AND INTERRUPTIONS entry using the up and down cursor keys. Press the ENTER key to select the DIPS AND INTERRUPTIONS menu. The screen will appear as shown in Figure 9-15.

```

IEC 1000-4-11 DIPS/INTERRUPTIONS  0A
STATE = ON
RUN HLL  NOMINAL Ut =230.0V
RUN SINGLE  DIP TO =0.0%
EOS ST. =ACTIVE  NO CYCLES =0.5
PREVIOUS SCREEN  START ANGLE =0.0

```

Figure 9-15: IEC Dips and Interrupts

STATE

This field enables or disables the -411 test mode. If an EOS option is present, it will be engaged when the STATE is toggled on. This field may also be used to reset a fault condition occurring on the EOS option due to a temperature or over current fault.

EOS STATE

This field can have one of three values:

N/A	Indicates no EOS option is present or the EOS option was not powered up when the STATE was enabled.
ACTIVE	The EOS option is active. When active, the -411 firmware will use the EOS for voltage dips at 0, 40 or 70% test levels. If a second generation EOS is used and the 70/80 Tap selection on the EOS is set to 80%, you must still program 70 as the DIP TO level to activate the 80% tap as the firmware only has one control code for this tap. Thus, the 70% programmed level will activate the 70/80 tap. The actual level will be determined by the setting of the EOS in this case.
OFF	The EOS option is in Bypass mode.

RUN ALL

The RUN ALL selection will cause the following automated test sequence suggested by the standard to be run:

Step	Output in % of U_T	No of Cycles	Start angle (degrees)	Repeat # times	Delay between repeats (s)
1	0	0.5	0	3	10
2	0	0.5	180	3	10
3	0	1	0,45,90	3 at diff \emptyset	10
4	0	5	45,90,135	3 at diff \emptyset	10
5	0	10	90,135,180	3 at diff \emptyset	10
6	0	25	180,225,270	3 at diff \emptyset	10
7	0	50	270,315,0	3 at diff \emptyset	10
8	40	0.5	0	3	10
9	40	0.5	180	3	10
10	40	1	0,45,90	3 at diff \emptyset	10
11	40	5	45,90,135	3 at diff \emptyset	10
12	40	10	90,135,180	3 at diff \emptyset	10
13	40	25	180,225,270	3 at diff \emptyset	10
14	40	50	270,315,0	3 at diff \emptyset	10
15	70	0.5	0	3	10
16	70	0.5	180	3	10
17	70	1	0,45,90	3 at diff \emptyset	10
18	70	5	45,90,135	3 at diff \emptyset	10
19	70	10	90,135,180	3 at diff \emptyset	10
20	70	25	180,225,270	3 at diff \emptyset	10
21	70	50	270,315,0	3 at diff \emptyset	10

Table 9-19: Dips and Interruptions Tests Performed During RUN ALL

The user can change the NOMINAL U_t voltage for this. The RUN ALL Command line will change to ABORT during the test. Selecting ABORT and pressing the ENTER key will terminate the test at any time and the output voltage will return to the nominal value.

RUN SINGLE

RUN SINGLE command will run a single test once. The Dip or Interrupt test is defined by the DIP TO, NO CYCLES, and START ANGLE parameters. These parameters must be set before starting the test. The following is a description of these parameters.

DIP TO: The dip voltage level as a percentage of the nominal voltage.

NO CYCLES: The dip duration in cycles.

START ANGLE: The start phase angle of the dip

Note: After each individual run, a 10 second delay is inserted.

9.2.6.2 VOLTAGE VARIATION TESTS

From the IEC1000-4-11 Main Menu screen shown in Figure 9-14, scroll to the VOLTAGE VARIATIONS entry using the up and down cursor keys. Press the ENTER key to select the VOLTAGE VARIATIONS menu. The screen will appear as shown in Figure 9-16.

IEC 1000-4-11 VOLTAGE VARIATIONS	
RUN ALL	NOMINAL U_T =230.0V
RUN SINGLE	REDUCE TO =40.0%
	FALL TIME =2.0S
	HOLD TIME =1.0S
PREVIOUS SCREEN	RISE TIME =2.0S

Figure 9-16: Voltage Variation screen

RUN ALL

The RUN ALL selection will cause the following automated test sequence suggested by the standard to be run:

Step	Type	Start V in % of U_T	Dwell time	End V in % of U_T	Delay between steps (s)
1	VSweep	100	2	40	0
2	Hold	40	1	40	0
3	VSweep	40	2	100	10
4	VSweep	100	2	40	0
5	Hold	40	1	40	0
6	VSweep	40	2	100	10
7	VSweep	100	2	40	0
8	Hold	40	1	40	0
9	VSweep	40	2	100	10
10	VSweep	100	2	0	0
11	Hold	0	1	0	0
12	VSweep	0	2	100	10
13	VSweep	100	2	0	0
14	Hold	0	1	0	0
15	VSweep	0	2	100	10
16	VSweep	100	2	0	0
17	Hold	0	1	0	0
18	VSweep	0	2	100	10

Table 9-20: Voltage Variations Test Performed During RUN ALL

The user can change the NOMINAL U_T voltage for this test. The RUN ALL Command line will change to ABORT during the test. Selecting ABORT and pressing the ENTER key will terminate the test at any time and the output voltage will return to the nominal value.

RUN SINGLE

RUN SINGLE command will run the test once. The Variation test is defined by the REDUCE TO, FALL TIME, HOLD TIME and RISE TIME parameters. These parameters must be set before starting the test. The following is a description of these parameters.

- REDUCE TO:** The lowest voltage level as a percentage of the nominal voltage. Thus, 0% is 0 Volts. 100% is full nominal voltage.
- FALL TIME:** The time in seconds it will take the output to reach the REDUCE TO voltage. Values must be entered in seconds. A 0.000 sec time may be used for abrupt voltage drops instead of voltage sweeps to support Edition 2.0 of the test standard. This requires firmware 2.38 or higher however.
- HOLD TIME:** The time in seconds the output will hold at the REDUCE TO voltage. Values must be entered in seconds.
- RISE TIME:** The time in seconds the output will reach the NOMINAL voltage from the REDUCE TO voltage. Values must be entered in seconds.

The timing of voltage variations is different between editions 1.0 and 2.0 of the IEC 61000-4-11 test standard. While the original standard used voltage ramps on both sides of the variation test level, the Edition 2.0 standard calls out an abrupt drop to the test level, followed by a voltage ramp back to the nominal voltage. Thus, for Edition 2.0, the fall time must be set to 0.000 seconds.

Furthermore, where under Edition 1.0 rise and fall times were specified in seconds, they are specified in number of cycles in Edition 2.0. This is an effort to normalize both 50 Hz and 60 Hz voltage variations.

Refer to Figure 9-17 and Figure 9-18 for an illustration of how these parameters affect the V RMS output under the different standard revisions.

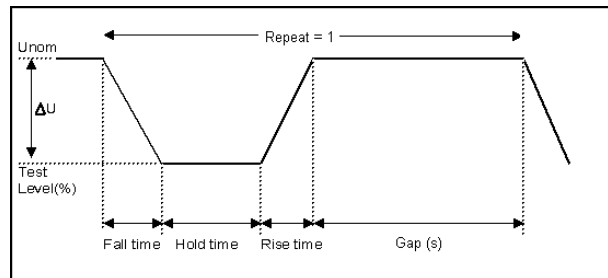

Figure 9-17: EN 61000-4-11 Voltage Variation specification- Edition 1.0

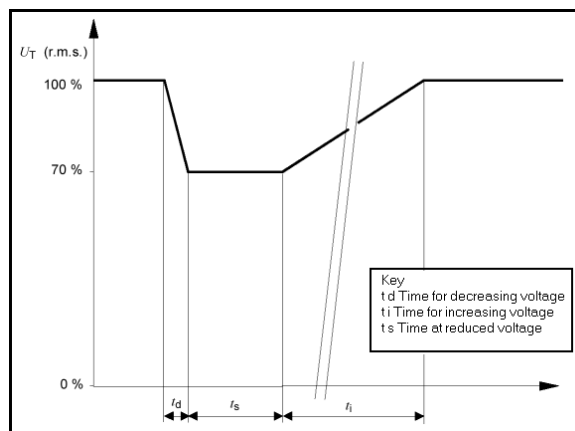

Figure 9-18: EN 61000-4-11 Voltage Variation specification- Edition 2.0

9.2.7 Using the GUI Windows Program for IEC 61000-4-11 Testing

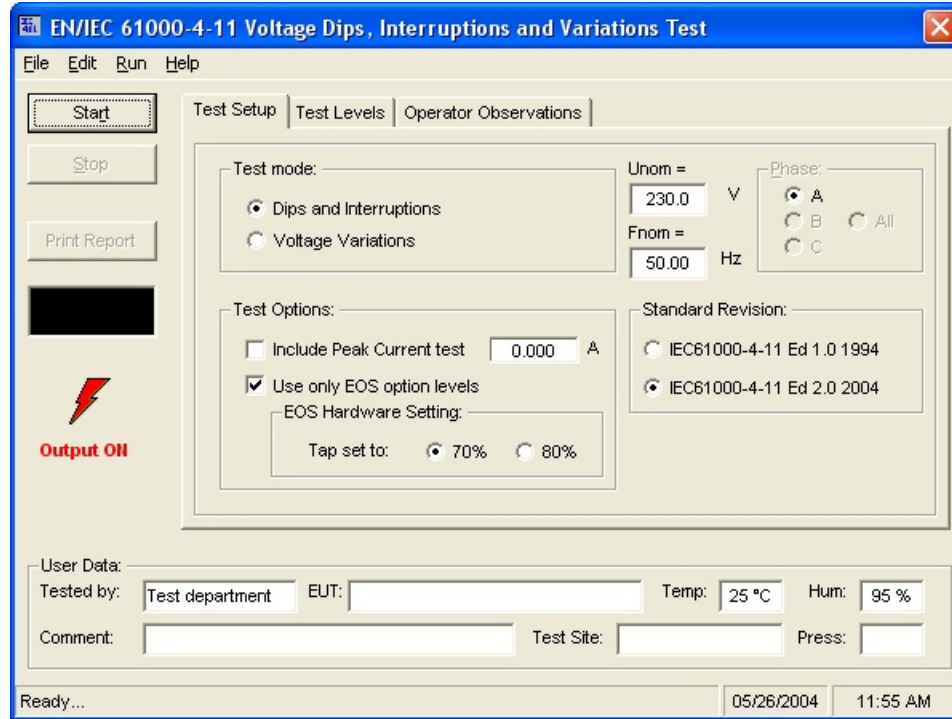

Figure 9-19: IEC 61000-4-11 GUI screen.

The GUI Windows control program will detect the presence of the –411 option on the CSW AC power source. It will also detect the presence of an EOS1 or EOS3 and use the EOS for the appropriate test levels. Test reports can be generated at the end of a test for documentation purposes.

To support Edition 2.0 of the IEC 61000-4-11 test standard, version 2.0.0.0 of the CSWGui or higher is required. Older versions of the GUI will only support Edition 1.0 tests. The desired Edition can be selected by the user and provides the relevant data entry mode for the Edition selected.

Generic tests files are distributed with the GUI program for both editions of the test standard. Files applicable to Edition 2.0 have ED20 in their file name. Do not mix these files, as the data setup will not be correct if you do. To load a test file, select the Mode (Dips or Vars) and test standard revision first, then use the File, Open menu to load the test parameters. Test parameters can be a function of the EUT class. The different files provided with the program cover the various EUT classes. The relevant EUT class 1, 2, 3 or X is listed in the file names.

The user must select the desired test type before executing the test. Since both test types require a number of test parameters, the test sequence parameters must be entered in the data entry grid or loaded from disk using the File, Open menu entry.

For complete details on how to use the GUI –411 option test screen, refer to the on-line help of the GUI program available from the Help menu.

9.3 IEC 61000-4-13 Option

9.3.1 General

The IEC413 option is capable of performing IEC 61000-4 section 13 Harmonics and inter harmonics low frequency immunity tests. The tests are based on IEC 61000-4-13:2002-03, First Edition. It is assumed that the user has a copy of the test standard available. This manual section only cover operation of the –413 option from the front-panel of the CSW Series power source.

Note: It is possible to upgrade the CSW Series and add the –413 option. Contact the California Instruments service department for information. support@calinst.com

9.3.2 Initial Setup

The user must set the operating voltage and close the output relay prior to the start of test. The following set of parameters must be set before the start of test.

1. Frequency to 50 or 60 Hz.
2. Voltage mode to AC.
3. Waveform to sine wave.

9.3.3 Tests Performed

The IEC61000-4-13 test consists of several types of tests. These tests can be run individually or in sequence (ALL). The following tests are available:

1. Harmonic combination test flat curve and over swing.
2. Sweep in frequency and resonance frequency detection.
3. Individual harmonics and inter harmonics.
4. Meister curve test.

Front Panel Entry

While it is possible to perform IEC 61000-4-13 testing from the front panel of the CSW Series AC power source, it is recommended to use the provided GUI Windows program for report generation. This also provides a more convenient way to perform Class 1 and User class tests as test levels can be saved to disk.

To perform a test from the keyboard, select the APPLICATIONS screen from the MENU 2 screen. The APPLICATIONS screen will appear as shown in Figure 9-20.



Figure 9-20: Application menu

Scroll to the IEC 61000-4-13 entry using the up and down cursor keys. Press the ENTER key to select the IEC 61000-4-13 main menu. The screen will appear as shown in Figure 9-21.

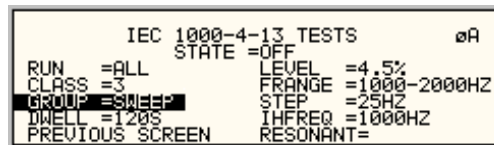

Figure 9-21: IEC 61000-4-13 Menu

9.3.3.1 IEC 61000-4-13 Screen Parameters

The IEC 61000-4-13 screen has the following common fields for all IEC 61000-4-13 test groups.

STATE

The STATE field must be set to ON before the test can run. Initial setup conditions must be met to run the test.

RUN

The RUN field has the following selections:

1. ALL Run all IEC 61000-4-13.
2. GROUP Run the selected group.
3. RANGE Run the selected range for the selected group.
4. POINT Run the selected frequency for the selected range and selected group.

Note: The RANGE and POINT do not apply to all groups. See individual groups for details.

When the test is running, this field will have the following selection:

1. ABORT The test will stop running and all parameters will return to the state prior to the start of the test.
2. PAUSE The test will pause at the time the ENTER key is pressed while the PAUSE field is selected. The field will change to RESUME. When the ENTER key is pressed again, the test will resume from the point it stopped.

EUT CLASS

This field selects the desired product or EUT class. There are four EUT classes. Class 1, 2 and 3 are predefined by the standard and its level parameters cannot be changed. The user class can be edited at any time. Changing between class 2 and 3 can be done while the state is on. Changing to the user class requires the state to be in the off position.

For Class 1 EUT, the user class must be used. Only class 2 and 3 test levels are pre-programmed. When using the provided, GUI Windows program, class 1 tests are set up by the GUI program automatically.

GROUP

This field selects the test GROUP. Selecting a group is required for editing the data fields associated with the group as well as running the individual group if run group is selected. The field has the following groups:

1. FCURVE This is the first part of harmonic combination test.
2. OSWING This is the second part of harmonic combination test.
3. SWEEP This is the sweep in frequency and resonance frequency detection.
4. HRAM This is the first part of the Individual harmonics and inter harmonics test.
5. IHARM This is the second part of the Individual harmonics and inter harmonics test.
6. MCURVE This is the Meister test.

See the appropriate sections for details on each group.

DWELL

This field will show the dwell time in seconds for each group during the test and will allow changes to the dwell time to be made.

The dwell time for the Meister curve group is the dwell time for each inter harmonics. This combined with the frequency step size results in a 5-minute test time per frequency decade.

The dwell time for the sweep group is the dwell time for each frequency decade.

9.3.3.2 IEC GROUPS

This section will describe the groups and parameters associated with IEC 61000-4-13. Refer to paragraph 9.3.3.1 for groups associated with the test.

FCURVE GROUP

If the FCURVE group is selected, the screen will appear as shown in Figure 9-22. The screen has the following parameters that are unique to the group:

```

      IEC 1000-4-13 TESTS      @A
      STATE =OFF
RUN  =ALL      LEVEL =80.0%
CLASS =3      PAUSE =10S
GROUP =FCURVE
DWELL =120S
PREVIOUS SCREEN
  
```

Figure 9-22: IEC 61000-4-13 FCurve

1. **LEVEL** Set the Flat curve clip level. This field can be set when the IEC 1000-4-13 is in the OFF state and the Class is set for USER class.
2. **PAUSE** Time in seconds the test will pause prior to proceeding to the following test. This field can be set at any time when the test is not running.

OSWING GROUP

If the OSWING group is selected, the screen will appear as shown in Figure 9-23. The screen has the following parameters that are unique to the group:

```

      IEC 1000-4-13 TESTS      @A
      STATE =OFF
RUN  =ALL      LEVEL =8.0%
CLASS =3      HARM NO=3
GROUP =OSWING PHASE =180.0°
DWELL =120S   PAUSE =10S
PREVIOUS SCREEN
  
```

Figure 9-23: IEC 61000-4-13 OSwing

1. **LEVEL** The level of the harmonics relative to the fundamental in percent. There are two levels, one for harmonic #3 and the other for harmonic #5. The harmonic number must be selected prior to the harmonic level entry. To change levels, the test state must be off and USER class must be selected.
2. **HARM NO** There are only two harmonic numbers. This field is used to set the harmonics level that corresponds to the harmonics number.
3. **PHASE** Sets the phase angle of the harmonics relative to the fundamental. The phase can be set when the test state is off and USER class is selected.
4. **PAUSE** Sets the time in seconds. The test will pause prior to proceeding to the following test. This field may be changed at any time as long as the test is not running.

SWEEP GROUP

If the SWEEP group is selected, the screen will appear as shown in Figure 9-24. The screen has the following parameters that are unique to the group:

```

      IEC 1000-4-13 TESTS          @A
      STATE =OFF
  RUN  =ALL          LEVEL =4.5%
  CLASS =3          FRANGE =1000-2000HZ
  GROUP =SWEEP      STEP  =25HZ
  DWELL =120S      IHFREQ =1000HZ
  PREVIOUS SCREEN  RESONANT=

```

Figure 9-24: IEC 61000-4-13 Sweep

1. LEVEL Sets the percentage level of the inter harmonics relative to the fundamental. The level is fixed for the entire frequency range, which is defined by FRANGE. To change level, the test state must be off and user class must be selected.
2. FRANGE The range is selected by rotating the shuttle. The range selection is required to change the level for the selected range. Also, an individual range sweep is possible by selecting the desired range and selecting RUN RANGE from the RUN field.
3. STEP The step size defines the inter harmonics sweep points. Step size is fixed for the entire sweep range. The STEP size can be changed when the test state is off.
4. IHFREQ This field will show the current inter harmonic frequency when the test is running. An inter harmonic frequency can be selected using the shuttle. To run a frequency without sweeping through the entire range, a RUN POINT can be selected.
5. RESONANT This field is used to report the resonant points, if any, after running the sweep test. No editing is allowed in this field. When the test is completed, a display of harmonics current versus frequency plot is available. To view the graph, select the field and press the ENTER key.

HARMONICS GROUP

If the Harmonics group is selected, the screen will appear as shown in Figure 9-25. The screen has the following parameters that are unique to the group:

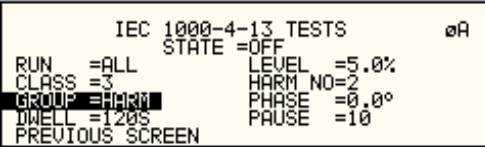

```
IEC 1000-4-13 TESTS      @A
STATE =OFF
RUN  =ALL                LEVEL =5.0%
CLASS =3                 HARM NO=2
GROUP =HARM              PHASE =0.0°
DWELL =120S             PAUSE =10
PREVIOUS SCREEN
```

Figure 9-25: IEC 61000-4-13 Harmonics

1. **LEVEL** Sets the percentage level of the harmonic relative to the fundamental. Each level is associated with a harmonic number. To change levels, the test state must be off and user class must be selected.
2. **HARM NO** Selecting a harmonic number using the shuttle knob will allow examination of the LEVEL and PHASE of each harmonic and changing the level and phase angle when USER class is selected.
3. **PHASE** Sets the phase angle of the harmonics relative to the fundamental. To change phase, the test state must be off and user class must be selected.
4. **PAUSE** Sets the pause time in seconds between harmonics tests. There is only one value for the entire test. The PAUSE value can be changed when the test is not running.

INTERHARMONICS GROUP

If the Harmonics group is selected, the screen will appear as shown in Figure 9-26. The screen has the following parameters that are unique to the group:

```

      IEC 1000-4-13 TESTS      @A
      STATE =OFF
RUN  =ALL      LEVEL =4.0%
CLASS =3      FRANGE =1000-2000HZ
GROUP =IHARM  STEP  =25HZ
DWEEL =120S   IHFREQ =1000HZ
PREVIOUS SCREEN PAUSE =10S
  
```

Figure 9-26: IEC 61000-4-13 Inter harmonics

1. LEVEL Sets the percentage level of the inter harmonics relative to the fundamental. The level is fixed for the entire frequency range defined by FRANGE. To change levels, the test state must be off and user class must be selected.
2. FRANGE The range is selected by rotating the shuttle. The range selection is required to change the level. An individual range step can be run by selecting the desired range, followed by RUN RANGE from the RUN field.
3. STEP The step size defines the inter harmonics sweep points. This step size is fixed for the entire range of the sweep. The STEP size can be changed when the test state is off.
4. IHFREQ This field shows the current inter harmonic frequency when the test is running. An inter harmonic frequency can be selected with the shuttle. To run an inter harmonic frequency without sweeping through the entire range, RUN POINT must be selected.
5. PAUSE Sets the time in seconds for which the test will pause between inter harmonic frequencies. There is only one value for the entire test. The PAUSE can be set when the test is not running.

MEISTER CURVE GROUP

If the Meister curve group is selected, the screen will appear as shown in Figure 9-27. The screen has the following parameters that are unique to the group:

```

IEC 1000-4-13 TESTS          0A
STATE =OFF
RUN  =ALL                     LEVEL =4.0%
CLASS =3                      FRANGE =1000-2000HZ
GROUP =IHHK
DWELL =120S                   IHFREQ =1000HZ
PREVIOUS SCREEN              PAUSE =10S

```

Figure 9-27: IEC 61000-4-13 Meister Curve

1. **LEVEL** Sets the percentage level of the inter harmonics relative to the fundamental. The level is fixed for the entire frequency range defined by FRANGE. To change levels, the test state must be off and user class must be selected.
2. **FRANGE** The range is selected by rotating the shuttle. The range selection is required to change the level. An individual range step can be run by selecting the desired range, followed by RUN RANGE from the RUN field.
3. **STEP** The step size defines the inter harmonics sweep points. This step size is fixed for the entire range of the sweep. The STEP size can be changed when the test state is off.
4. **PAUSE** Sets the time in seconds for which the test will pause between ranges. There is only one value for the entire test. The PAUSE can be set when the test is not running. For the Meister curve test, the pause time is normally set to 0 secs. If a value other than 0 is entered, the inter harmonics are set to 0% during the pause times.
5. **RESONANT** This field is used to report the resonant points, if any, after running the Meister curve test. No editing is allowed in this field. When the test is completed, a display of harmonics current versus frequency plot is available. To view the graph, select the field and press the ENTER key.

9.3.3.3 RUNNING THE TEST

The test sequence used is a function of the EUT class. The end user needs to determine the appropriate class of EUT. The test protocol is document in the IEC 61000-4-13 test standard. For reference, the test flow charts are shown here. It is assumed that the end user has a copy of the actual test standard however.

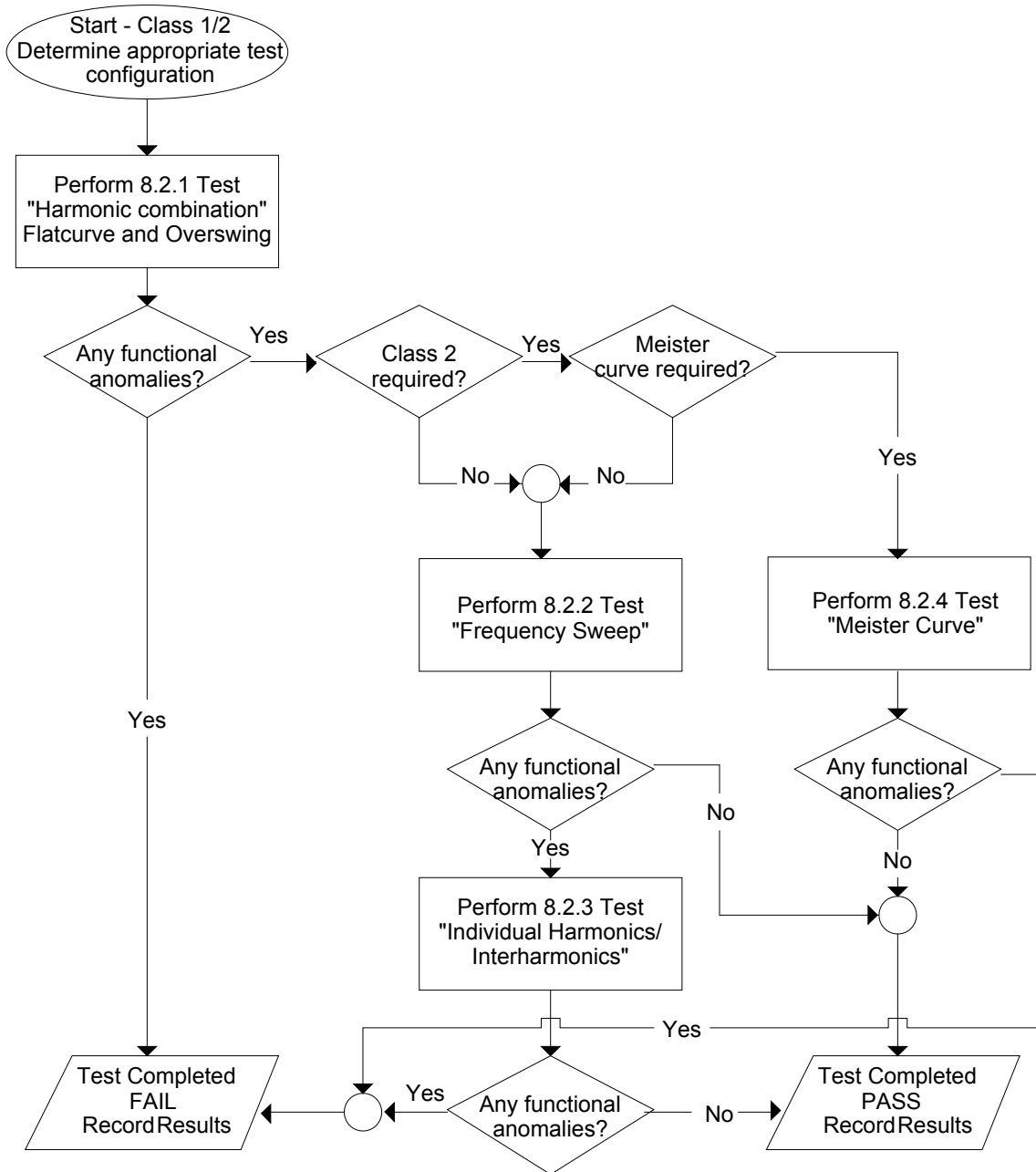

Figure 9-28: IEC 61000-4-13 Test Flowchart Class 1 and 2

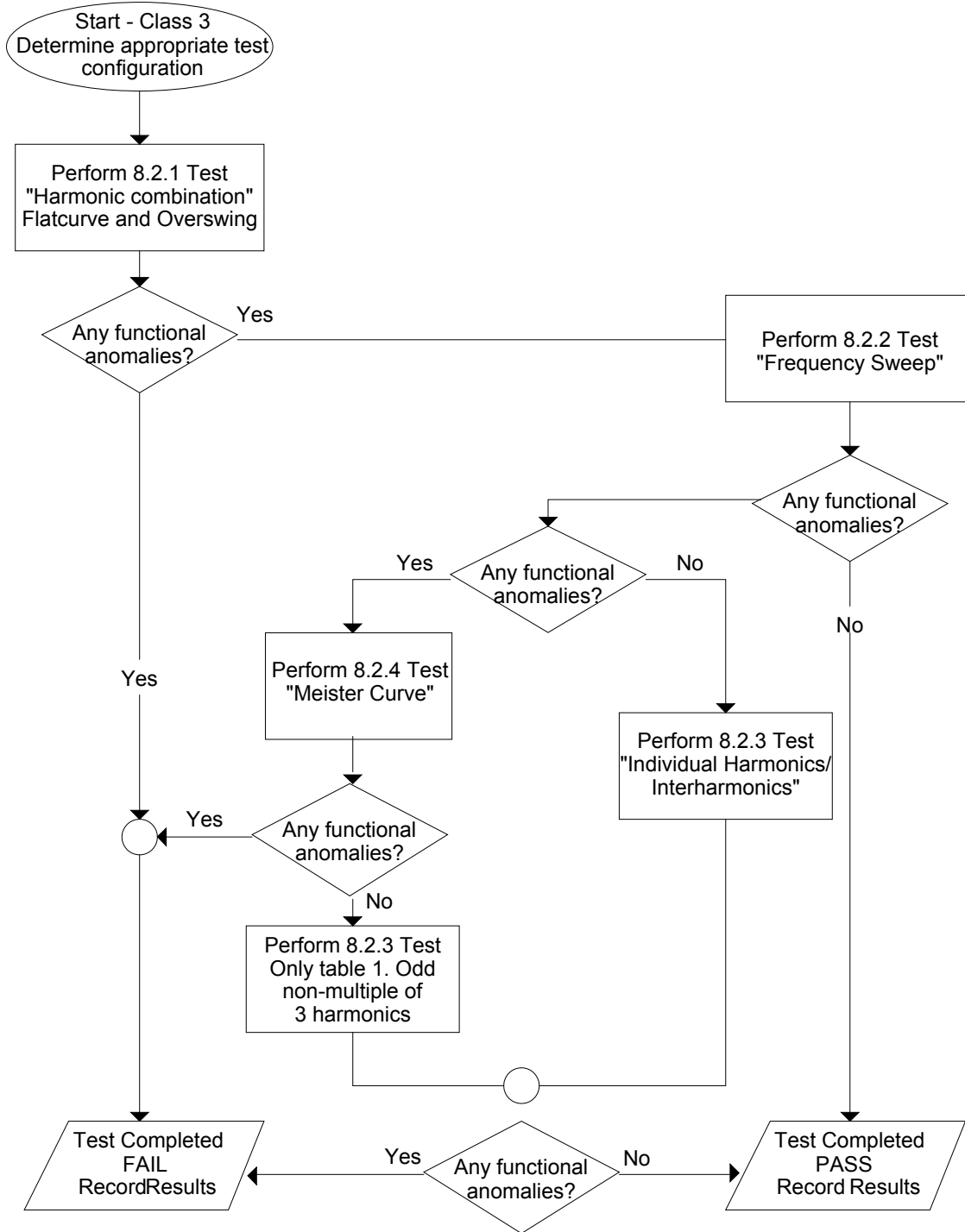

Figure 9-29: IEC 61000-4-13 Test Flowchart Class 3

To run the test, the IEC 61000-4-13 mode must be selected. Refer to paragraph 4 for access to the screen. The following conditions have to be met before running the test:

1. Prior to the test, set the nominal voltage, frequency, and phase angle. The frequency must be 50 or 60 Hz. Function must be set to sine wave.
2. Select EUT CLASS 2, 3 or USER. The default parameters for the USER class are identical to those for class 3. If USER class is selected, the level and phase parameters can be edited. For Class 1 EUT's, the USER class must be used as well. In this case, set the levels to those called out in the test document.
3. Set the STATE to ON. It will take a few seconds to initialize data required to perform the test.
4. If it is desired to run all tests, select ALL from the RUN parameter with the shuttle knob and press the ENTER key. The tests will run in the following sequence:

FCURVE, OSWING, SWEEP, HARM, IHARM,MCURVE

Note: The test for class 3 will take about 25 minutes, class 2 slightly less.

5. While the test is running, the ABORT and PAUSE selection is accessible from the RUN field by rotating the shuttle.
6. If it is desired to run a specific group, the group must be selected from the group screen. Also, the RUN GROUP must be selected prior to the start of test.
7. To run an individual range, applicable for sweep and individual harmonics only, the desired range and the RUN RANGE mode must be selected prior to the start of the test. In case the harmonics group is selected, RUN RANGE will run the harmonics from the second harmonics to the harmonics number specified by the HARM NO field. See Figure 9-25.
8. To run individual harmonics or individual inter harmonics, set the harmonic number or the inter harmonics frequency and select RUN POINT prior to running the test.

9.3.3.4 INTERHARMONICS

A single inter harmonic frequency may be generated using the INTERHARMONICS screen. This screen allows insertion of any inter harmonic from 1Hz to 2400Hz in 1Hz steps. The amplitude level of the harmonics range is from 0 to 20% of the programmed voltage. To select the inter harmonics screen, press the menu screen until the MENU 2 screen appears as shown in Figure 9-30. Select INTERHARMONICS using the up or down key.



Figure 9-30: MENU 2 SCREEN

INTERHARMONICS SCREEN

The inter harmonics screen will appear as shown in Figure 9-31. This screen has the following parameters:



Figure 9-31: INTERHARMONICS SCREEN

1. REFERENCE This field will enable the Inter harmonics generator if ON is selected and will disable the inter harmonics generation if OFF is selected.
2. REF. COUPL If turned on, the REF. VOLT will follow the programmed voltage value.
3. REF. VOLT This field must be programmed to a value if REF. COUPL is off. This value has a range from 0 to 230 volts. This value is set to a value equal to the phase A voltage if the REF. COUPL is turned on.
4. VOLTAGE This field programs the Inter harmonic level in percentage of the REF.VOLT. This value has a range from 0 to 20%

9.4 Option –704: MilStd704 Tests

The MIL704 option is made up of both firmware that resides in the power source and the GUI Windows application program. The firmware covers revision D and E of the Mil-Std704 standard. The GUI covers the remaining revisions A, B, C and F. This provides coverage of all available standard revisions.

The user interface for each implementation is different however. The revision D and E tests can be operated directly from the power source's front panel or through the supplied GUI program. The revision A-C, F tests can only be operated through the supplied GUI program. Thus, for rev A-C and F, a Windows PC and interface is required.

Section 9.8.1 covers operation of the firmware based revision D and E tests.

For information regarding the operation of the MIL-STD-704 revision A, B, C, and F tests with the GUI, please refer to the Avionics Software Manual (CI part no. 4994-971 included on CDROM). Note that future updates of the GUI may include overlapping coverage for revisions D and E in the software as the GUI program is designed to support all revisions. For now, revisions D and E have no associated data files in the GUI.

9.4.1 Option –704: MIL-STD-704 rev D & E Tests. (Firmware)

9.4.1.1 General

The MIL704 option is capable of performing most sections of MIL-STD-704 rev D and E in either of the AC or DC mode.

Note: The Distortion Spectrum tests:

*Table I and II, Figure 7
Table III, Figure 12
Table IV, Figure 18*

are not supported by the –704 option. These tests require the use of additional external equipment.

9.4.1.2 Initial Setup

Nominal parameters for the AC Power source are as follows:

Output Voltage	115V L-N
Output Frequency	400 Hz

Nominal parameters for the DC Power source are as follows:

Output Voltage	28V or 270V L-N
----------------	-----------------

A setting outside these nominal values will disable the test and will prevent access to its Menu screens.

9.4.1.3 Revision

The MIL704 option defaults to Revision E. The System is capable of performing Revision D test by changing the selection to Revision D. All Revision D tests can be performed except for the 270V DC TRANSIENT and ABNORMAL where Revision E level are used despite the revision selection.

All levels and timing in this document refers to Revision E. For Revision D refer to MIL-STD-704D date 9/30/1980

9.4.1.4 Tests Performed

9.4.1.4.1 STEADY STATE

AC Mode:

1. Steady State Voltage and Frequency test
2. Waveform Distortion test
3. Voltage Modulation test
4. Voltage Unbalance test
5. Phase Unbalance test
6. Frequency Modulation test
7. Transient Voltage low and high test
8. Transient Frequency low and high test

DC Mode:

1. Steady State Voltage test
2. Ripple test

9.4.1.4.2 EMERGENCY TEST

AC Mode:

1. Emergency Voltage minimum and maximum test
2. Emergency Frequency minimum and maximum test

DC Mode:

1. Emergency Voltage minimum and maximum test

9.4.1.4.3 ABNORMAL TEST

AC Mode:

1. Abnormal Voltage under
2. Abnormal Voltage over
3. Abnormal Frequency under
4. Abnormal Frequency under

DC Mode:

1. Abnormal Voltage under
2. Abnormal Voltage over

9.4.1.5 Front Panel Entry

To perform a test from the keyboard, from the MENU 2 screen, select the APPLICATIONS screen. The APPLICATIONS screen will appear as shown in Figure 9-32.



Figure 9-32: Application Menu

Scroll to the MIL-STD-704 entry using the up and down cursor keys. Press the ENTER key to select the MIL704 main menu. One of the screens will appear as shown in Figure 9-33. The voltage mode and setting will define which menu to select. Refer to Section 9.4.1.2

Note: The user has to turn on the Output relay before starting a test and set the steady state setup for the test.

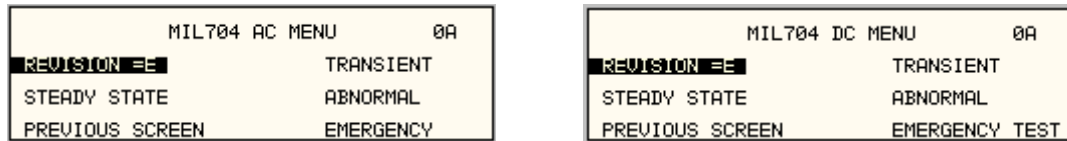

Figure 9-33: MIL704 Menu

9.4.1.6 Revision Selection

The default Revision is E. Revisions supported are D and E. The Revision can be changed from the front panel. Scroll to the REVISION entry using the up and down cursor keys (see Figure 9-33). Use the shuttle to change the selection.

9.4.1.7 AC MODE TESTS

9.4.1.7.1 Steady State Test

Scroll to the STEADY STATE AC entry using the up and down cursor keys. Press the ENTER key to select the STEADY STATE screens. The screen will appear as shown in Figure 9-34.



Figure 9-34: Steady State Menu

The MIL704 Steady state 1 and Steady state 2 screens have the following tests:

- 1 VOLTAGE
- 2 FREQUENCY
- 3 VOLT UNBALANCE
- 4 PHASE DIFFERENCE
- 5 VOLT MODULATION
- 6 FREQ MODULATION
- 7 DISTORTION

The above tests can be selected by scrolling to the highlighted selection using the up and down cursor keys and the ENTER key to start the selected test.

VOLTAGE

This test will change the output voltage in the following sequence:

- 108V for 1 minute.
- 118V for 1 minute.
- 115V for 1 minute.

The ← key (backspace) will terminate the test at any time.

FREQUENCY

This test will change the output frequency in the following sequence:

- 393Hz for 1 minute.
- 407Hz for 1 minute.
- 400Hz for 1 minute.

The ← key (backspace) will terminate the test at any time.

VOLT UNBALANCE

This test will change the output voltage for the selected phase only in the following sequence:

- 112V for 1 minute.
- 118V for 1 minute.
- 115V for 1 minute.

The test will be repeated on three phase systems to include all three phases if the coupling is set to all.

The ← key (backspace) will terminate the test at any time.

PHASE DIFFERENCE

This test applies to three phase systems only. The phase angle for the selected phase will change relative to phase A in the following sequence:

If phase B is selected:

- 236° for 1 minute.
- 244° for 1 minute.
- 240° for 1 minute.

If phase C is selected:

- 116° for 1 minute.
- 124° for 1 minute.
- 120° for 1 minute

VOLTAGE MODULATION

This test will vary the output voltage by $\pm 2.5V$ rms over a period of one second. The test will last for 2 minutes. The ← key (backspace) will terminate the test at any time.

FREQUENCY MODULATION

This test will vary the output frequency by $\pm 4Hz$ over a period of one minute. The test will last for 4 minutes. The ← key (backspace) will terminate the test at any time.

WAVEFORM DISTORTION

This test will generate a 5% THD voltage distortion on the output voltage waveform. The distortion is caused by using a clipped sine wave. The test will last for 1 minute. The ← key (backspace) will terminate the test at any time.

9.4.1.7.2 TRANSIENT TEST

From the MIL704 main menu (Figure 9-33) scroll to the TRANSIENT AC entry using the up and down cursor keys. Press the ENTER key to select the TRANSIENT screens. The screen will appear as shown in Figure 9-35.

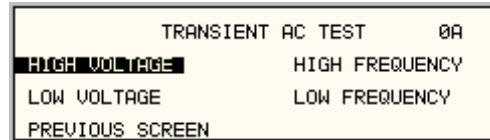

Figure 9-35: Transient Menu

The MIL704 Transient screen has the following tests:

- 1 HIGH VOLTAGE
- 2 LOW VOLTAGE
- 3 HIGH FREQUENCY
- 4 LOW FREQUENCY

The above tests can be selected by scrolling to the highlighted selection using the up and down key and the ENTER key to start the selected test.

HIGH VOLTAGE

This test will change the output voltage for the selected phase in the following sequence:

- 180V for 10 msec.
- Linearly reduced to 118V in 78msec.
- Stay at 118V for 87msec before returning to 115V.

Prior to the test, a range change may take place if the power source is set for the low voltage range.

The ← key (backspace) will terminate the test at any time.

Note: A range change will result in momentary loss of power to the EUT. If this is not acceptable, the power source must be left in high range at all times.

LOW VOLTAGE

This test will change the output voltage for the selected phase only in the following sequence:

- 80V for 10 msec.
- Linearly increase to 108V in 70msec.
- Stay at 108V for 95msec before returning to 115V.

The ← key (backspace) will terminate the test at any time.

HIGH FREQUENCY

This test will change the output frequency in the following sequence:

- 425Hz for 1 sec.
- 420Hz for 4 sec.
- 410Hz for 5 sec.
- 407Hz for 4 sec.

LOW FREQUENCY

This test will change the output frequency in the following sequence:

- 375Hz for 1 sec.
- 380Hz for 4 sec.
- 390Hz for 5 sec.
- 393Hz for 4 sec.

9.4.1.7.3 EMERGENCY TEST

From the MIL704 main menu (Figure 9-33) scroll to the EMERGENCY AC entry using the up and down cursor keys. Press the ENTER key to select the EMERGENCY screens. The screen will appear as shown in Figure 9-36.

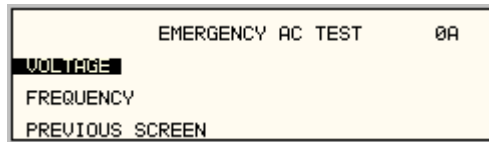

Figure 9-36: Emergency Menu

The EMERGENCY SCREEN has the following tests:

- 1 VOLTAGE
- 2 FREQUENCY

The above tests can be selected by scrolling to the highlighted selection using the up and down key and the ENTER key to start the selected test.

VOLTAGE

This test will change the output voltage in the following sequence:

- 108V for 1 minute.
- 118V for 1 minute.
- 115V for 1 minute.

The ← key (backspace) will terminate the test at any time.

FREQUENCY

This test will change the output frequency in the following sequence:

- 393Hz for 1 minute.
- 407Hz for 1 minute.
- 400Hz for 1 minute.

The ← key (backspace) will terminate the test at any time.

9.4.1.7.4 ABNORMAL TEST

From the MIL704 main menu (Figure 9-33) scroll to the ABNORMAL AC entry using the up and down cursor keys. Press the ENTER key to select the ABNORMAL screens. The screen will appear as shown in Figure 9-37.

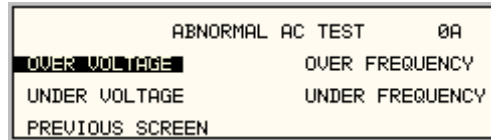

Figure 9-37: Abnormal Screen

The ABNORMAL SCREEN has the following tests:

- 1 OVER VOLTAGE
- 2 UNDER VOLTAGE
- 3 OVER FREQUENCY
- 4 UNDER FREQUENCY

The above test can be selected by scrolling to the highlighted selection using the up and down key and the ENTER key to start the selected test.

OVER VOLTAGE

This test will change the output voltage for the selected phase in the following sequence:

- 180V for 50msec.
- The voltage gradually decays with time to 125 volt by the following equation:
 $V = 124.6 + 2.77/t$, for $0.05 \leq t \leq 6.925$
- Stay at 125V for 93 seconds before returning to 115V.

Prior to the test, a range change may take place if the power source is set at the low voltage range.

The ← key (backspace) will terminate the test at any time.

Note: A range change will result in momentary loss of power to the EUT. If this is not acceptable, the power source must be left in high range at all times.

UNDER VOLTAGE

This test will change the output voltage for the selected phase in the following sequence:

- 0V for 7 seconds.
- 100V for 93 seconds.
- The ← key (backspace) will terminate the test at any time.

OVER FREQUENCY

This test will change the output frequency in the following sequence:

- 480Hz for 5 seconds.
- 420Hz for 9 seconds.

The ← key (backspace) will terminate the test at any time.

UNDER FREQUENCY

This test will change the output frequency in the following sequence:

- 0Hz for 7 seconds.
- 380Hz for 7 seconds.

The ← key (backspace) will terminate the test at any time.

9.4.1.8 DC TESTS

If the output voltage is set for 28V DC or 270V DC the MIL704 DC Main selection screen will appear as seen in Figure 9-38.

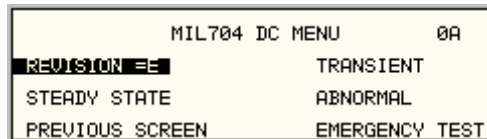

Figure 9-38: MIL704 DC Menu

9.4.1.8.1 Steady State Test

Scroll to the STEADY STATE entry using the up and down cursor keys. Press the ENTER key to select the STEADY STATE screen. The screen will appear as shown Figure 9-39.

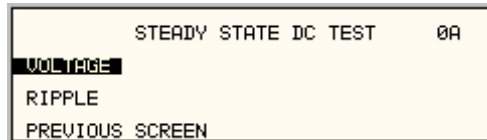

Figure 9-39: Steady State DC

The MIL704 STEADY STATE screen has the following tests:

- 1 VOLTAGE
- 2 RIPPLE

The above tests can be selected by scrolling to the highlighted selection using the up and down key and the ENTER key to start the selected test.

VOLTAGE

This test will change the output voltage for the selected phase in the following sequence:

1. 28V system:
 - 22V for 1 minute.
 - 29V for 1 minute.
 - 28V for 1 minute.
2. 270V system:
 - 250V for 1 minute.
 - 280V for 1 minute.
 - 270V for 1 minute.

The ← key (backspace) will terminate the test at any time.

DC RIPPLE

This test will impose a 400Hz frequency component to the output voltage. The test will last for 2 minutes. The level of the ripple is as follows:

1. 28V system:

- ±1.5V.
- 2. 270V system:
 - ±6.0V.

The ← key (backspace) will terminate the test at any time.

9.4.1.8.2 Transient Test

From the MIL704 DC MENU scroll to the TRANSIENT DC entry using the up and down cursor keys. Press the ENTER key to select the TRANSIENT screen. The screen will appear as shown in Figure 9-40.

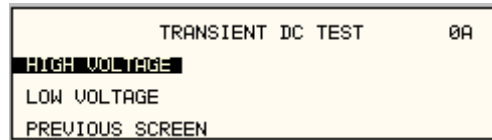

Figure 9-40: Transient Menu

The Transient Test has the following tests:

- 1 HIGH VOLTAGE
- 2 LOW VOLTAGE

HIGH VOLTAGE

This test will change the output voltage for the selected phase in the following sequence:

1. 28V System
 - 50V for 12.5 msec.
 - Linearly reduce to 29V in 70msec.
 - Stay at 29V for 92.5msec before returning to 28V.
2. 270V System
 - 330V for 20 msec.
 - Linearly reduce to 280V in 20msec.
 - Stay at 280V for 135msec before returning to 270V.

Prior to the test, a range change may take place if the power source is set for the low voltage range.

The ← key (backspace) will terminate the test at any time.

Note: A range change will result in momentary loss of power to the EUT. If this is not acceptable, the power source must be left in high range at all times.

LOW VOLTAGE

This test will change the output voltage for the selected phase in the following sequence:

1. 28V System
 - 18V for 15 msec.
 - Linearly increase to 22V in 85msec.
 - Stay at 22V for 75msec before returning to 28V.

2. 270V System

- 200V for 10 msec.
- Linearly increase to 250V in 30msec.
- Stay at 250V for 135msec before returning to 270V.

The ← key (backspace) will terminate the test at any time.

9.4.1.8.3 Abnormal Test

From the MIL704 DC MENU scroll to the ABNORMAL DC entry using the up and down cursor keys. Press the ENTER key to select the ABNORMAL screen. The screen will appear as shown in Figure 9-41.

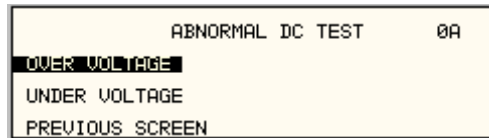

Figure 9-41: Abnormal Test Screen

The Abnormal Test has the following tests:

- 1 OVER VOLTAGE
- 2 UNDER VOLTAGE

The above tests can be selected by scrolling to the highlighted selection using the up and down cursor keys and the ENTER key to start the selected test.

OVER VOLTAGE

This test will change the output voltage for the selected phase in the following sequence:

1. 28V system:
 - 50V for 50msec.
 - The voltage gradually decays with time to 31.5 volts by the following equation:

$$V = 31.38 + 0.93/t. \text{ for } 0.05 \leq t \leq 7.758$$
 - Stay at 31.5V for 92.242 seconds before returning to 28V.
2. 270V system:
 - 350V for 50msec.
 - The voltage gradually decays with time to 290 volts by the following equation:

$$V = 289.6 + 3.02/t. \text{ for } 0.05 \leq t \leq 7.55$$
 - Stay at 290V for 92.45 seconds before returning to 270V.

Prior to the test, a range change may take place if the power source is set at the low voltage range. Note: See Section 9.4.1.7.2 under HIGH VOLTAGE.

The ← key (backspace) will terminate the test at any time.

Note: A range change will result in momentary loss of power to the EUT. If this is not acceptable, the power source must be left in high range at all times.

UNDER VOLTAGE

This test will change the output voltage for the selected phase in the following sequence:

1. 28V system:

- 0V for 7sec.
 - 20V for 93sec.
2. 270V system:
 - 0V for 7sec.
 - 240V for 93sec.

The ← key (backspace) will terminate the test at any time.

9.4.1.8.4 Emergency Test

From the MIL704 DC MENU scroll to the EMERGENCY DC entry using the up and down cursor keys (Figure 9-42). Press the ENTER key to start the EMERGENCY TEST.

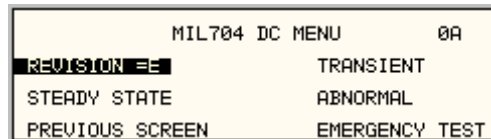

Figure 9-42: Emergency Test

VOLTAGE

This test will change the output voltage for the selected phase in the following sequence:

1. 28V system:
 - 18V for 1 minute.
 - 29V for 1 minute.
 - 28V for 1 minute.
2. 270V system:
 - 250V for 1 minute.
 - 280V for 1 minute.
 - 270V for 1 minute.

The ← key (backspace) will terminate the test at any time.

9.5 ABD Option: Airbus ABD0100.1.8 Test

For information regarding the operation of the ABD0100.1.8 tests with the CSWGui, please refer to the Avionics Software Manual (CI part no. 4994-971 included on CDROM).

9.6 AMD Option: Airbus AMD24C Test

For information regarding the operation of the Airbus AMD24C tests with the CSWGui, please refer to the Avionics Software Manual (CI part no. 4994-971 included on CDROM).

9.7 A350 Option: Airbus A350 (ABD0100.1.8.1) Test

For information regarding the operation of the Airbus A350 tests with the CSWGui, please refer to the Avionics Software Manual (CI part no. 4994-971 included on CDROM).

9.8 787 Option: Boeing B787-0147 Test

For information regarding the operation of the Boeing B787-0147 tests with the CSWGui, please refer to the Avionics Software Manual (CI part no. 4994-971 included on CDROM).

9.9 WHM Option

9.9.1 General

This section describes the WHM option for the CSW Series Power Source.

9.9.2 Specification

All specifications are the same as the standard CSW Power Source specifications in addition to the following specifications:

Watt-hour

0-6.000KW	0.01KWH + 0.1% <100Hz
	0.02KWH +0.1% 100-500Hz
>6.000KW	Times three of the above specification

9.9.3 Local Operation

- From the Menu screen 2, select the APPLICATIONS SETUP 2 screen. The screen will appear as shown in Figure 9-43. Use the up and down key to position the cursor to the WH METER field. Press the Enter Key.

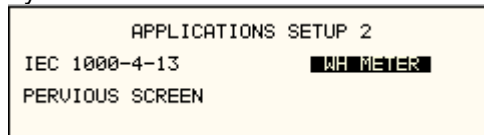

Figure 9-43: Application Screen

- The WATT-HOURS METER screen shown in Figure 9-44 has the following fields:

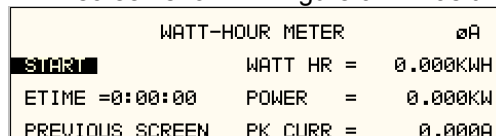

Figure 9-44 Watt-Hour Meter Screen

START: This field will activate the watt-hour measurements. Moving the shuttle clockwise when the field is highlighted will activate the watt hour function and the field will change to STOP as shown in Figure 9-45.

- ETIME: This field will accumulate the time in hours, minutes and seconds.
- WATT HR: This field will accumulate the watt-hour in KWH.
- POWER: This field will report the instantaneous power in KW.
- PK CURR: This field will report the peak current and will hold the maximum reading.

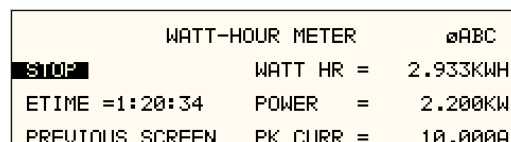

Figure 9-45: WH-Meter Screen With Function Active

Note: Changing from stop to start will stop the measurement and will maintain the last data record for the watt-hour meter. To restart the measurements, the field is toggled to the stop position from the start position and the previous data will be reset to zeros.

WATT HR, POWER and PK CURR will display the data for the phase selected with the phase key. If the phase is selected for all phases in a two or three phase system, the WATT HR and POWER fields will show the sum of all phases. PK CURR will remain at the last selected phase.

Note: Changing Mode of operation from single phase to three phases while the Watt-hour meter is in the active state will generate an error: "Input buffer full". This error will halt the measurements. To clear the error, the Watt-hour meter must be switched to the stopped state. It is advised that the Watt-hour meter should be set to the stop state before changing the mode of operation.

9.9.4 Remote PROGRAMMING

The following SCPI command will be used to control the WHM functions:

WHMeter:

[STATe]	Turn on or of the watt hour function
ETIMe?	Return the elapse time
WHOur?	Return the watt-hour in KWH

WHMeter[:STATe]

This command will start or stop the watt-hour function.

Command Syntax	WHMeter[:STATe]<bool>
Parameters	0 OFF 1 ON
Examples	WHM ON
Query Syntax	WHM[:STATe]?
Returned Parameters	0 1

WHMeter:ETIMe?

This command will return the total amount of time the watt-hour meter accumulated. The returned data has four fields separated by commas. These fields are hours, minutes, seconds and milliseconds.

Command Syntax	WHMeter:ETIMe?
Parameters	none
Query Syntax	WHM:ETIM?
Returned Parameters	h,mm,ss,ms

WHMeter:WHOur?

Phase Selectable

This command will return the total accumulated kilowatt-hour for the selected phase. If coupling is set to all, the value returned is the sum of all phases in the system irregardless of the selected phase.

Command Syntax	WHMeter:WHOur?
Parameters	none
Query Syntax	WHM:WHO?
Returned Parameters	<numeric value>

Note: If the watt-hour meter is active, the total power of all phases in the system will be returned when querying the power.

10. Error Messages

Any errors that occur during operation from either the front panel or the remote control interface will result in error messages. Error messages are displayed in the upper left hand corner of the LCD display. They are also stored in the error message queue from which they can be queried using the SYST:ERR? Query. The error queue has a finite depth. If more error messages are generated than can be held in the queue, a queue overflow message will be put in the last queue location. To empty the queue, use the error query until the No Error result is received.

Errors appearing on the LCD will generally remain visible until the user moves to another screen. If multiple error messages are generated in succession, only the last message will be visible as there is only space for one error message on the LCD display.

The same area of the display is also used to display status messages. While error messages always have a negative error number, status messages have a positive number.

The table below displays a list of possible error and status messages along with their possible cause and remedy.

Number	Message String	Cause	Remedy
0	"No error"	No errors in queue	
-100	"Command error"	Unable to complete requested operation	Unit may be in a mode inconsistent with request.
-102	"Syntax error"	Command syntax incorrect.	Misspelled or unsupported command
-103	"Invalid separator"	SCPI separator not recognized	See SCPI section of programming manual.
-104	"Data type error"	Data type invaled.	Check command for supported data types
-108	"Parameter not allowed"	One or more additional parameters were received.	Check programming manual for correct number of parameters
-109	"Missing parameter"	Too few parameters received for requested operation	Check programming manual for correct number of parameters
-110	"Command header error"	Command header incorrect	Check syntax of command.
-111	"header separator error"	Invalid command separator used.	Use semi-colon to separate command headers
-112	"Program mnemonic too long"	Syntax error	Check programming manual for correct command syntax
-113	"Undefined header"	Command not recognized error	Check programming manual for correct command syntax
-120	"Numeric data error"	Data received is not a number	Check programming manual for correct command syntax
-121	"Invalid character in number"	Number received contains non-numeric character(s)	Check programming manual for correct command syntax
-123	"Exponent too large"	Exponent in number exceeds limits	Check programming manual for correct parameter range
-128	"Numeric data not allowed"	Number received when number is not allowed.	Check programming manual for correct command syntax

Number	Message String	Cause	Remedy
-168	"Block data not allowed"	Block data was sent.	Check programming manual for correct command syntax
-200	"Execution error"	Command could not be executed	Command may be inconsistent with mode of operation such as programming frequency when in DC mode.
-201	"Invalid while in local"	Command issued but unit is not in remote state	Put instrument in remote state before issuing GPIB commands.
-203	"Command protected"	Command is locked out	Some commands are supported by the unit but are locked out for protection of settings and are not user accessible.
-210	"Trigger error"	Problem with trigger system.	Unit could not generate trigger for transient execution or measurement.
-211	"Trigger ignored"	Trigger request has been ignored.	Trigger setup incorrect or unit was not armed when trigger was received. Check transient system or measurement trigger system settings.
-213	"Init ignored"	Initialization request has been ignored	Unit was told to go to armed state but was unable to do so. Could be caused by incorrect transient system or measurement acquisition setup.
-220	"Parameter error"	Parameter not allowed.	Incorrect parameter or parameter value. Check programming manual for allowable parameters
-221	"Setting conflict"	Requested setting conflicts with other setting in effect.	Check other settings. E.g. trying to program a DC offset while in AC mode
-222	"Data out of range"	Parameter data outside of allowable range.	Check programming manual for allowable parameter values
-223	"Too much data"	More data received than expected	Check programming manual for number of parameters or data block size
-224	"Illegal parameter value"	Parameter value is not supported	Check programming manual for correct parameters
-226	"Lists not same length"	One or more transient lists programmed has different length.	All lists must be of same length or transient cannot be compiled and executed.
-241	"Hardware missing"	N/A	N/A
-254	"Media full"	No storage space left to save settings or data.	Delete other settings or data to make room.
-255	"Directory full"	Too many waveform directory entries	Delete one or more waveforms from waveform memory to make room.
-256	"File name not found"	Waveform requested not in directory	Check waveform directory for waveform names present.
-257	"File name error"	Incorrect filename	Too many or non ASCII characters used in waveform file definition.
-283	"Illegal variable name"	Variable name illegal.	Use ASCII characters only

Number	Message String	Cause	Remedy
-300	"Device specific error"	Hardware related error	Check hardware for proper operation.
-311	"Memory error"	Waveform memory checksum error.	May be the result of incomplete user-defined waveform download. Check interface and try downloading waveform again. Successful download may clear this error condition. Alternatively, use TRAC:DEL:ALL command to clear waveform memory.
-314	"Save/recall memory lost"	User setup register contents lost	Store setup in same register again.
-315	"Configuration memory lost"	Hardware configuration settings lost.	Contact CI service department at support@calinst.com to obtain instructions on restoring configuration data.
-330	"Self-test failed"	Internal error	Contact CI service department at support@calinst.com
-350	"Queue overflow"	Message queue full.	Too many message. Read status using SYST:ERR query until 0, "No Error" is received indicating queue empty.
-400	"Query error"	Unable to complete query.	Check programming manual for correct query format and parameters
-410	"Query INTERRUPTED"	Query issued but response not read.	Check application program for correct flow. Response must be read after each query to avoid this error.
-420	"Query UNTERMINATED"	Query incomplete.	Check for terminator after query command.
-430	"Query DEADLOCKED"	Query cannot be completed	Check application program for multiple queries
-440	"Query UNTERMINATED"	Query incomplete.	Check for terminator after query command.
-831	"Lan connection missing"		
-831	"Duplicate IP, Set to DHCP"		
-832	"Duplicate IP, REM set to reject"		
-833	"Duplicate IP, LOC set rejected"		
-834	"Out of reach IP"		
1	"Output volt fault"	Output voltage does not match programmed value.	Load exceeds current limit and unit is in Constant Voltage (CV) mode of operation. Reduce load or increase CL setting Output voltage is driven above programmed voltage by external influence (Load, voltage kickback, etc.)

Number	Message String	Cause	Remedy
2	"Current limit fault"	Current limit exceeded.	Load exceeds current limit and unit is in Constant Voltage (CV) mode of operation. Reduce load or increase CL setting
3	"Temperature fault"	Temperature of heat sink too high.	Reduce load. Ensure proper air flow and exhaust clearance. Check fan(s) for operation.
4	"External sync. error"	Could not sync to external sync signal.	External sync signal missing, disconnected or out of range.
5	"Initial memory lost"	Power on settings could not be recalled.	Save power on settings again to overwrite old content.
6	"Limit memory lost"	Hardware configuration settings lost.	Contact CI service department at support@calinst.com to obtain instructions on restoring configuration data.
7	"System memory lost"	Memory corrupted.	Recycle power.
8	"Calibration memory lost"	Calibration data lost.	Contact CI service department at support@calinst.com to obtain instructions on restoring calibration data or recalibrate unit.
9	"Start angle must be first sequence"	Start phase angle in wrong place..	Start phase angles can only be programmed at the start of a transient list. Once a transient is in progress, phase angle cannot be changed.
10	"Illegal for DC"	Operation not possible in DC mode.	Switch to AC or AC+DC mode.
11	"Duplicate sequence"	N/A	N/A
12	"Too many sequence"	N/A	N/A
13	"Missing list parameter"	One or more transient list parameters missing.	Check programmed lists.
14	"Voltage peak error "	Peak voltage exceeds internal bus voltage	This error may occur when selecting user defined wave shapes with higher crest factors. Reduce programmed RMS value.
16	"Illegal during transient"	Operation requested not available while transient is running.	Wait till transient execution is completed or abort transient execution first.
17	"Output relay must be closed"	Operation not possible with open relay	Close relay before attempting operation. E.g. transient execution requires output relay to be closed.
18	"Trans. duration less than 1msec"	Dwell time below minimum or 1 msec	Increase dwell time to at least 1 msec.
19	"Clock and sync must be internal"	Operation not possible with external clock	Switch to internal sync. (Default)
20	"Input buffer full"	Too much data received.	Break up data in smaller blocks.

Number	Message String	Cause	Remedy
22	"Waveform harmonics limit"	Harmonic contents of user defined wave shape is too high and could damage amplifier output stage.	Reduce harmonic content or reduce fundamental frequency programmed.
24	"Output Relay must be closed"	Attempt to change voltage range while output relay is closed.	Open output relay first, then change range.
25	"Overvoltage Protection Trip"	Over voltage trip limit exceeded.	Check for inductive kickbacks or overshoot on eut.
26	"Peak Current Protection Trip"	Peak current exceeds trip limit.	Reduce load or increase trip level.
29	"DC component exceed limit"	Waveform selected has too much DC content to be supported on AC coupled voltage range.	Use AC waveform without DC offset only or select DC coupled voltage range. (Applies to MX with –HV models only).
30	"Dc Bus Fault"	Amplifier DC bus lower than required to support the output load	AC Line input too low.

Table 10-1: Error Messages.

11. Index

+		EOS	
+/- key	46	State	143
7		error messages	176
704	160	Ethernet	76
A		F	
A350 Option	172	FFT	
ABD option	172	analysis	91
ABD0100.1.8	81	data displays	93
Acoustic	26	Finish	
active group	87	paint	25
ALC mode	77	Frequency Range	20
AMD Option	172	front panel	43
arrow keys	44	lock	43
aux. PS	106	front panels	
B		blank	37
B787 Option	172	Function Strobe	24
blinking		Functional Test	38
parameter entry	44	G	
bridge rectifier	105	GPIB	76
C		H	
calibration		handles	27
measurements	112	I	
calibration factors	82, 83	IEC 1000-4-11	80
CE" mark	26	IEC 61000-4-11	
circuit breaker	43, 105	Edition 1.0	140
clip level	68	Edition 2.0	140
clock and lock	37	IEEE-488	76
Clock and Lock		IGBT's	110
-LKS configuration	80	iM Series	12
clock mode	54	Immunity	26
Construction		installation	30
internal	25	Introduction	12
Cooling	25	K	
current limit	106	keypad	45
custom waveforms	87	function	45
creating	87	knob	44
deleting	87	L	
downloading	87	LAN	23, 76
D		Configuration	74
DC offset	54	connector	36
Dimensions	25	MAC Address	36
Distorted output	120, 121	Settings	74
DVM	106	-LAN option	27
E		LCD display	48
Emissions	26	LED	106, 119
		LED indicators	119

list transient	101	Shock	25
M		Short Circuit	
MAC Address	36	current	24
maintenance	119	shuttle	44
Material		SET mode	44
chassis	25	Shuttle	
MEAS key	45	IMMEDIATE mode	44
measurement calibration	82	single phase	37
MENU key	45	slew rates	103
MIL/STD-704	80	status	43
MS704	81	step transient	100
O		system	
Offset Voltage		single phase	12
DC	20	system interconnect	105
oscillator	105	system interface	37
oscillator assembly	105	T	
output		temperature	
frequency	53	over	43
voltage	53	Temperature	
output calibration	82, 83	operating, storage	25
output mode	54	terminal block	
OUTPUT ON/OFF key	46	connections	25
OUTPut[:STATe]	175	three phase	37
Overcurrent	24	output	37
overload	43	Three phase	105
Overtemperature	24	transient	
Overvoltage	24	execution	104
P		transient execution	67
phase angle	54	transients	
PHASE key	46	list	101
power factor	105	pulse	100
PROG key	45	slew rate	103
pulse transient	100	step	100
R		switching waveforms	103
registers	67	Transients	
remote control	43	Input	24
Remote Inhibit	34	trigger output	24
repeat	67	troubleshooting	119
replacement parts	122	U	
RJ45		UP key	47
connector	36	USB	23, 76
RS232	76	connector	35
Cable	35	V	
Connector	35	Vibration	25
RTCA DO160	80	volt mode	54
S		voltage drop	
Safety	26	cables	32
sense	119	voltage ranges	38
wiring	31	W	
SET key	46	WAVE key	45
SET mode	44	waveform	
		data displays	95

Waveform		WHM.....	81
acquisition.....	94	Wire Sizes.....	32
waveform group	79	wiring	
Weight	25	input	30