

**Models 3112, 3106B, 3119,
3115, 3117, 3116C**

Double-Ridged Waveguide Horn Antennas

User Manual



Model 3117



Model 3116C

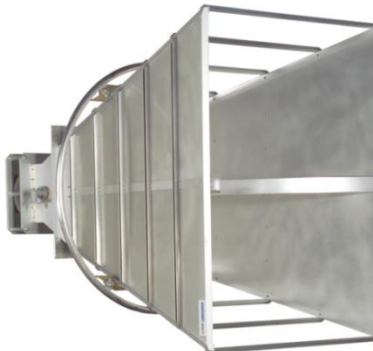

Model 3112

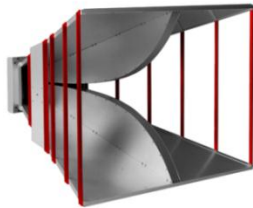

Model 3106B

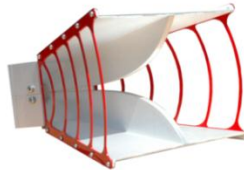

Model 3115

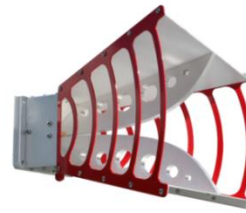

Model 3119

 **ETS-LINDGREN**[™]
An ESCO Technologies Company

ETS-Lindgren Inc. Although the information in this document has been carefully reviewed and is believed to be reliable, ETS-Lindgren does not assume any liability arising out of the application or use of any product or circuit described herein; nor does it convey any license under its patent rights nor the rights of others. All trademarks are the property of their respective owners.

© Copyright 2010–2013 by ETS-Lindgren Inc. All Rights Reserved. No part of this document may be copied by any means without written permission from ETS-Lindgren Inc.

Trademarks used in this document: The *ETS-Lindgren* logo is a trademark of ETS-Lindgren Inc.

Revision Record

MANUAL, DOUBLE-RIDGED WAVEGUIDE HRN FAM | Part #399318, Rev. C



Revision	Description	Date
A	Initial Release	October, 2010
B	Update 3116B to 3116C. Updates to all sections.	May , 2012
C	Updated 7-TR boom information; updated mounting information; added 3106B on 7-TR mounting instructions	August, 2013

Table of Contents

Notes, Cautions, and Warnings	v
1.0 Introduction	7
Double-Ridged Waveguide Horn Antennas	7
Model 3112	7
Model 3106B	7
Model 3119	8
Model 3115	8
Model 3117	8
Model 3116C	9
Optional Items	9
Tripod Options	9
7-TR Boom Options	10
Model 3112 Positioning System	11
ETS-Lindgren Product Information Bulletin	11
2.0 Maintenance	13
Annual Calibration	13
Replacement and Optional Parts	13
Service Procedures	14
3.0 Specifications	15
Electrical Specifications	15
Model 3112	15
Model 3106B	15
Model 3119	16
Model 3115	16
Model 3117	16
Model 3116C	17
Physical Specifications	17
Model 3112	17
Model 3106B	17
Model 3119	17
Model 3115	18
Model 3117	18
Model 3116C	18
4.0 Mounting Instructions	19

4-TR Mounting Instructions	19
Included Mounting Hardware	19
Attach Mounting Bracket to Antenna	20
Attach Stinger Mount (Models 3117 and 3116C Only)	21
Mount Antenna and Bracket to 4-TR	22
7-TR and Mast Mounting Options.....	23
2x2 Boom Mounting Options	24
5.0 Mounting a Model 3112 to the Optional Positioning System	25
Rear Plate Mounting Pattern	25
Connecting the Optional Positioning System	27
Input Locations	27
Air Polarization Option.....	28
6.0 Mounting a Model 3106 Series Antenna to a 7-TR	29
7.0 Typical Data.....	33
Model 3112.....	33
Model 3106B.....	35
Model 3119.....	37
Model 3115.....	40
Model 3117.....	43
Model 3116C	46
Appendix A: Warranty	49
Appendix B: Typical Measured Radiated Patterns	51
Model 3106B.....	51
Model 3119.....	56
Model 3115.....	62
Model 3117.....	68

Notes, Cautions, and Warnings

	<p>Note: Denotes helpful information intended to provide tips for better use of the product.</p>
	<p>Caution: Denotes a hazard. Failure to follow instructions could result in minor personal injury and/or property damage. Included text gives proper procedures.</p>
	<p>Warning: Denotes a hazard. Failure to follow instructions could result in SEVERE personal injury and/or property damage. Included text gives proper procedures.</p>



See the ETS-Lindgren *Product Information Bulletin* for safety, regulatory, and other product marking information.

This page intentionally left blank.

1.0 Introduction

The **ETS-Lindgren family of Double-Ridged Waveguide Horn Antennas** consists of linearly polarized broadband antennas ranging in frequency from 100 MHz to 40 GHz. These antennas were designed and built specifically from EMI measurements and specifications compliance testing. However, they can also be used for antenna gain, pattern measurement, surveillance, automotive, and military EMC immunity applications.

Double-Ridged Waveguide Horn Antennas

MODEL 3112

The Model 3112 Double-Ridged Waveguide Horn is a linearly polarized antenna covering the frequency range of 100 MHz to 1 GHz.

The Model 3112 is especially effective for generating high electromagnetic fields with relatively low power input. The antenna is also useful for receiving low-level signals where high gain characteristics are needed.



MODEL 3106B

The Model 3106B Double-Ridged Waveguide Horn is a linearly polarized broadband antenna covering a frequency range of 200 MHz to 2.5 GHz. It is precision-machined from aluminum, making it lightweight and durable. Two brackets are attached to the sides of the antenna so it can be polarized either horizontal or vertically.

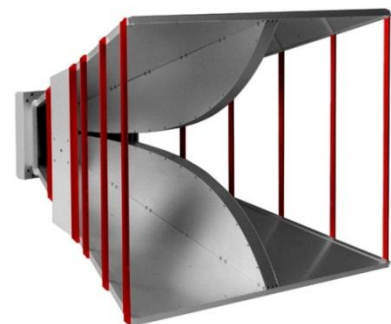

The Model 3106B has high gain and excellent VSWR characteristics over the entire frequency range (see Appendix B on page 51 for data charts). It is especially effective for generating high electromagnetic field with relatively low power input. The antenna is also useful for receiving low level signals where high gain characteristics are needed.

MODEL 3119

The Model 3119 Double-Ridged Waveguide Horn is a linearly polarized broadband antenna covering the frequency range of 400 MHz to 6 GHz.

The Model 3119 is ideally suited for immunity over 1 GHz and as a reference antenna for wireless testing. In addition, the 3119 is useful for antenna pattern measurement as a source antenna.



MODEL 3115

The Model 3115 Double-Ridged Waveguide Horn is a linearly polarized broadband antenna covering the frequency range of 750 MHz to 18 GHz.

The Model 3115 is ideally suited for IEC 61000-4-3 and MIL-STD 461E immunity tests as well as ANSI C634 and EN 55033 emissions testing. In addition, the 3115 is useful for antenna pattern measurement as a source antenna.

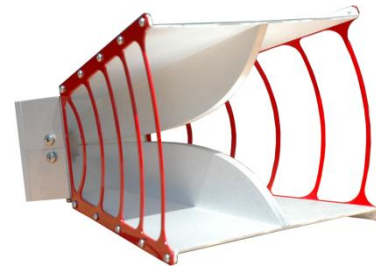

MODEL 3117

The Model 3117 Double-Ridged Waveguide Horn is a linearly polarized broadband antenna covering the 1 GHz to 18 GHz frequency range.

A single well-defined main lobe radiation pattern over the entire frequency range provides excellent illumination of the Equipment Under Test (EUT).



The Model 3117 is ideally suited for IEC 6100-4-3 and MIL-STD 661/462 immunity tests as well as ANSI C634 and EN 55033 emissions tests. The 3117 includes a stinger for flexible mounting options.

MODEL 3116C

The Model 3116C Double-Ridged Waveguide Horn is a linearly polarized broadband antenna covering the frequency range 10 GHz to 40 GHz. It is designed and built specifically for emissions and susceptibility testing.

The Model 3116C is precision-machined from aluminum. A 50 Ω Type K (2.92 mm) female connector is mounted on the base block of the antenna for increased performance at high frequencies. For flexible mounting options, the 3116C includes a bracket that accepts a 1/4–20 thread screw and a rear stinger-style mount.



Optional Items

TRIPOD OPTIONS

ETS-Lindgren offers the following non-metallic, non-reflective tripods for use at both indoor and outdoor EMC test sites.

- **4-TR Tripod**—Constructed of linen phenolic and delrin, designed with an adjustable center post for precise height adjustments.

Maximum Height:	2.0 m (80.0 in)
Minimum Height:	94 cm (37.0 in)
Maximum Load:	11.8 kg (26.0 lb)



- 7-TR Tripod**—Constructed of PVC and fiberglass components, providing increased stability for physically large antennas. The unique design allows for quick assembly, disassembly, and convenient storage. Allows several different configurations, including options for manual or pneumatic polarization. Quick height adjustment and locking wheels provide ease of use during testing.



Maximum Height:	2.17 m (85.8 in)
Minimum Height:	0.8 m (31.8 in)
Maximum Load:	13.5 kg (30 lb)

7-TR BOOM OPTIONS

Boom Type	Function
Straight (109042)	For general antenna mounting on a 7-TR.
Offset (108983)	For general antenna mounting on a 7-TR with pneumatic or manual polarization. Can also be used to mount stinger-type antennas.
Stinger Only (118947)	For stinger mount antennas only.
Centerline Rotation (108507)	For Model 3106 Series antennas only; when changing polarization, maintains centerline rotation. For mounting information, see <i>Mounting a Model 3106 Series Antenna to a 7-TR</i> on page 29.

MODEL 3112 POSITIONING SYSTEM

The Model 3112 features an option for a fixed height pneumatic-assisted polarization positioning system. The position system is ideal when using the Model 3112 for immunity testing.



Power Supply:	160 mA 120 VAC Optional 220 VAC available
Pneumatic Interface:	50–80 PSI
Weight:	181.43–226.76 kg 400–500 lb
Maximum Height:	355.6 cm 140 in
Maximum Load:	194.13 cm 76.43 in

ETS-Lindgren Product Information Bulletin

See the ETS-Lindgren *Product Information Bulletin* included with your shipment for the following:

- Warranty information
- Safety, regulatory, and other product marking information
- Steps to receive your shipment
- Steps to return a component for service
- ETS Lindgren calibration service
- ETS Lindgren contact information

This page intentionally left blank.

2.0 Maintenance

CAUTION

Before performing any maintenance, follow the safety information in the ETS-Lindgren *Product Information Bulletin* included with your shipment.



Maintenance of a Double-Ridged Waveguide Horn Antenna is limited to external components such as cables or connectors.

If you have any questions concerning maintenance, contact ETS Lindgren Customer Service.

Annual Calibration

See the *Product Information Bulletin* included with your shipment for information on ETS-Lindgren calibration services.

Replacement and Optional Parts



ETS-Lindgren may substitute a similar part or new part number with the same functionality for another part/part number. Contact ETS-Lindgren for questions about part numbers and ordering parts.

Following are the part numbers for ordering replacement or optional parts for the Double-Ridged Waveguide Horn Antennas.

Part Description	Part Number
Model 3112 Pneumatic Assisted Pedestal	109621
4-TR Tripod	4-TR
4-TR Mounting Bracket, 3115	101501
7-TR Tripod Options	
1. 7-TR Tripod, No Polarization	7-TR
2. 7-TR Tripod, Pneumatic Polarization	7-TR/POL
3. 7-TR Tripod, Manual Polarization	7-TR/POL-M

Part Description	Part Number
7-TR Boom Assembly Options	
1. Boom Assembly, Antenna Mounting, Straight—Standard for general antenna mounting on 7-TR	109042
2. Boom Assembly, Antenna Mounting, Offset—Standard for general antenna mounting on 7-TR/POL and 7-TR/POL-M; can also be used to mount stinger-type antennas.	108983
3. Boom, Stinger Only— For stinger-mount antennas only.	118947
4. Boom Assembly, Antenna Mounting, 3106—For mounting Model 3106 antennas only.	108507

Service Procedures

For the steps to return a system or system component to ETS-Lindgren for service, see the *Product Information Bulletin* included with your shipment.

3.0 Specifications

Electrical Specifications

MODEL 3112

Frequency Range	100 MHz—1 GHz
VSWR Ratio (Average)	< 1.6:1
Maximum Continuous Power	800 W
Peak Power	1.5 kW (Type N, female connector) 2.5 kW CW (EIA 1 5/8-in flange connector)
Impedance (Nominal)	50 Ω
Connector	Type N, female EIA 1 5/8-in flange
Front-to-Back Ratio	20 dB
Cross Polarization	20 dB minimum

MODEL 3106B

Frequency Range	200 MHz—2.5 GHz
VSWR Ratio (Average)	<1.6:1
Maximum Continuous Power	800 W
Peak Power	1600 W
Impedance (Nominal)	50 Ω
Connector	Type N, female
Front-to-Back Ratio	20 dB
Cross Polarization	20 dB minimum

MODEL 3119

Frequency Range	400 MHz—6 GHz
VSWR Ratio (Average)	3.5:1
Maximum Continuous Power	800 W
Peak Power	2500 W
Impedance (Nominal)	50 Ω
Connector	Type N, female
Front-to-Back Ratio	20 dB
Cross Polarization	20 dB minimum

MODEL 3115

Frequency Range	750 MHz—18 GHz
VSWR Ratio (Average)	5:1
Maximum Continuous Power	750 W
Peak Power	500 W
Impedance (Nominal)	50 Ω
Connector	Type N, female
Front-to-Back Ratio	20 dB
Cross Polarization	20 dB minimum

MODEL 3117

Frequency Range	1 GHz—18 GHz
VSWR Ratio (Average)	3.5:1 max <2:1 above 1.5 GHz
Maximum Continuous Power	300 W
Peak Power	400 W
Impedance (Nominal)	50 Ω
Connector	Type N, female
Front-to-Back Ratio	>6.42 dB at 1 GHz >12.08 dB at 2 GHz >20 dB at 3 GHz—18 GHz
Cross Polarization	20 dB at 3 GHz—18 GHz

MODEL 3116C

Frequency Range	10 GHz—40 GHz
VSWR Ratio (Average)	2.5:1 max
Maximum Continuous Power	20 W @ 40 GHz 40 W @ 10 GHz
Peak Power	200 W
Impedance (Nominal)	50 Ω
Connector	Type K, female 2.92 mm
Front-to-Back Ratio	20 dB
Cross Polarization	20 dB minimum

Physical Specifications

MODEL 3112

Width	203.2 cm (80 in)
Depth	182 cm (71.65 in)
Height	139.7 cm (56 in)
Approximate Weight	86.1 kg (189.81 lb)

MODEL 3106B

Width	93.3 cm (36.7 in)
Depth	97.8 cm (38.5 in)
Height	72.9 cm (28.7 in)
Approximate Weight	11.8 kg (26.01 lb)

MODEL 3119

Width	48.84 cm (19.23 in)
Depth	40 cm (15.74 in)
Height	31.37 cm (12.35 in)
Approximate Weight	7.4 kg (16.3 lb)

MODEL 3115

Width	24.4 cm (9.6 in)
Depth	27.9 cm (11 in)
Height	15.9 cm (6.2 in)
Approximate Weight	1.8 kg (4 lb)

MODEL 3117

Width	17.5 cm (6.9 in)
Depth	17.5 cm + 15.5 cm mount (6.9 in + 6.1 in mount)
Height	15.5 cm (6.1 in)
Approximate Weight	1.13 kg (2.5 lb)

MODEL 3116C

	With Stinger	With Bracket
Width	10.8 cm 4.25 in	
Depth	25.73 cm 10.13 in	13.03 cm 5.13 in
Height	6.35 cm 2.5 in	8.9 cm 3.5 in
Approximate Weight	0.334 kg 0.74 lb	0.201 kg 0.44 lb

4.0 Mounting Instructions

CAUTION

Before connecting any components or operating the Double-Ridged Waveguide Horn Antennas, follow the safety information in the ETS-Lindgren *Product Information Bulletin* included with your shipment.

CAUTION

The Double-Ridged Waveguide Horn Antennas are precision instruments. Handle with care.



Make sure that no part of the antenna is in contact with the tripod or tower.

4-TR Mounting Instructions

CAUTION

Due to the size of the Model 3112, 3119, and 3106B Double-Ridged Waveguide Horn Antennas, do not mount them onto a 4-TR.

CAUTION

Failure to provide continuous support of the antenna when attaching or removing the mounting bracket or thumbscrews may result in damage.

INCLUDED MOUNTING HARDWARE

All Double-Ridged Waveguide Horn Antennas (except the 3112, 3119, and 3106B) mount directly to a 4-TR Tripod using the included mounting hardware; no additional hardware is required.



The Model 3117 Model and 3116C include a stinger mount for centerline rotation measurements; see page 21 for more information.

All Double-Ridged Waveguide Horn Antennas ship with the following mounting hardware:

- Mounting bracket drilled to accept ETS-Lindgren or other tripod mount with 1/4–20 threads.
- Thumbscrews (2) for attaching the antenna to the mounting bracket.

ATTACH MOUNTING BRACKET TO ANTENNA



The Model 3117 Model and 3116C include a stinger mount for centerline rotation measurements; see page 21 for more information.

The following illustration represents a typical assembly of the mounting bracket to an antenna. The Model 3116C is shown; however, the steps are similar for each of the Double-Ridged Waveguide Horn Antennas.

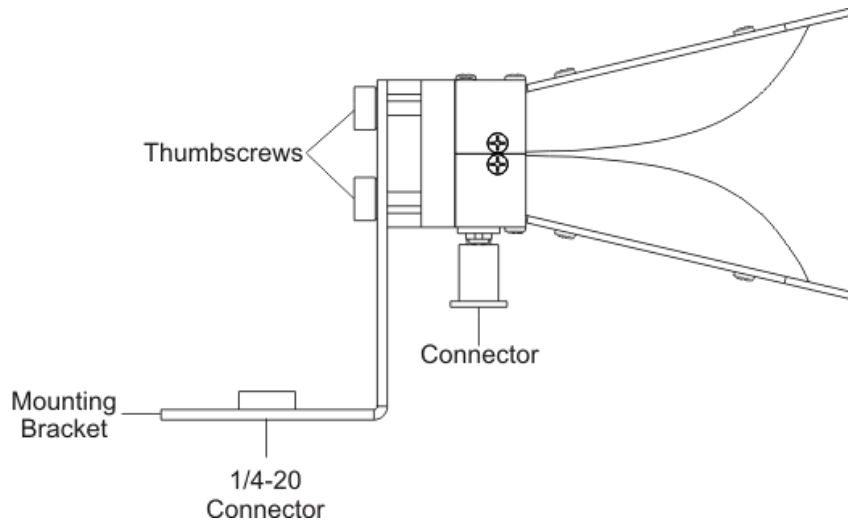

1. Hold the antenna with the connector pointing to the floor and align the holes on the back of the antenna with the ones on the bracket provided.
2. Select set of holes for horizontal or vertical polarization as desired.
3. Insert both thumbscrews and tighten.

ATTACH STINGER MOUNT (MODELS 3117 AND 3116C ONLY)

The Model 3117 Model and 3116C include a stinger mount for centerline rotation measurements.

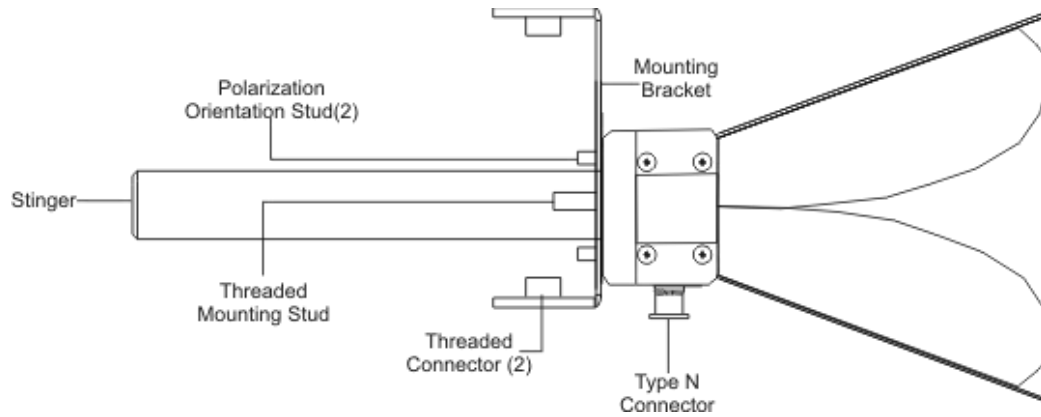

1. Hold the antenna with the connector pointing to the floor and align the holes on the back of the antenna with the ones on the bracket provided.
2. Select set of holes for horizontal or vertical polarization as desired.
3. Insert both thumbscrews and tighten.
4. Align the stinger with the threaded mounting stud then tighten.

MOUNT ANTENNA AND BRACKET TO 4-TR

1. Attach the mounting bracket to the 4-TR by aligning the 1/4–20 connector on the bracket with the 1/4–20 bolt on the tripod. Support the antenna securely while turning the mounting bracket to tighten the connection.
2. To change polarization, support the antenna securely and remove the thumbscrews. Turn the antenna to align the holes on the mounting bracket with the desired set of holes on the back of the antenna. Re-insert the thumbscrews and tighten.



Model 3117 shown mounted onto 4-TR

7-TR and Mast Mounting Options

CAUTION

Due to the size of the Model 3112, do not mount it onto a 7-TR.



For a list of 7-TR boom options, see page 10. For 7-TR mounting instructions, see the 7-TR manual.



For instructions to mount a Model 3106B to a 7-TR, see page 29.



The stinger on the Model 3117 and Model 3116C enables you to mount the antenna directly to an ETS-Lindgren 7-TR without additional hardware.

This illustration provides an option for mounting a Double-Ridged Waveguide Horn Antenna (except Model 3106B and Model 3112) onto an ETS-Lindgren 7-TR Tripod or mast. Contact the ETS-Lindgren Sales Department for information on ordering optional mounting hardware.

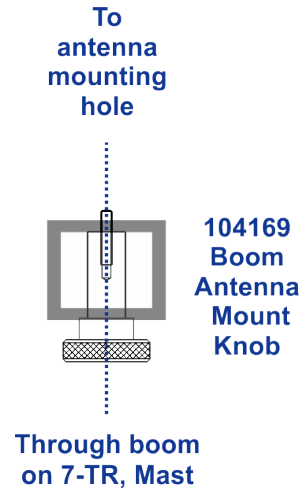

2x2 Boom Mounting Options



2x2 boom refers to a typical 2-inch by 2-inch boom.

Following are options for mounting a Double-Ridged Waveguide Horn Antenna onto a 2x2 boom. Contact the ETS-Lindgren Sales Department for information on ordering optional mounting hardware.

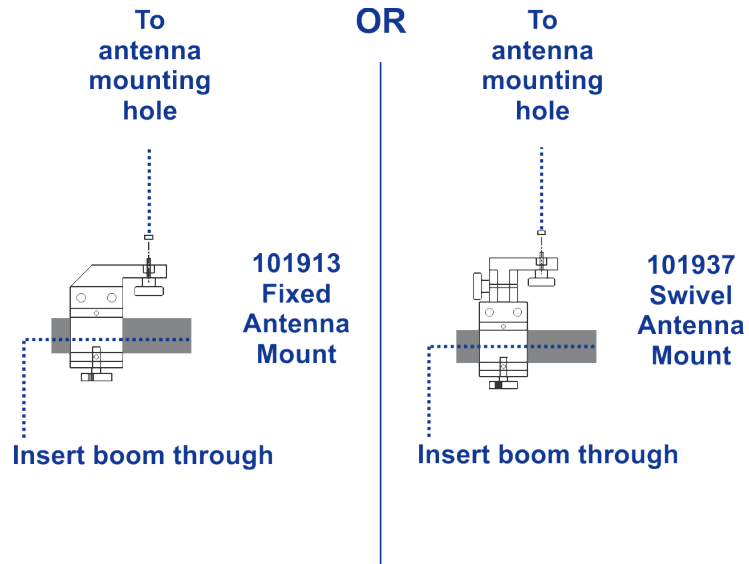

5.0 Mounting a Model 3112 to the Optional Positioning System

CAUTION

Before connecting any components or operating the Double-Ridged Waveguide Horn Antennas, follow the safety information in the ETS-Lindgren *Product Information Bulletin* included with your shipment.

CAUTION

Failure to provide continuous support of the antenna when attaching or removing the antenna from the positioning system may result in damage and/or personal injury.



The customer is responsible for providing an adequate and safe support system for the Model 3112 Double-Ridged Waveguide Horn when moving and attaching to the optional positioning system.

Rear Plate Mounting Pattern

The Model 3112 Double Ridged Waveguide Horn Antenna includes a series of outer holes in the rear plate that is compatible with the optional positioning system. Additionally, the mounting holes can be used to meet customer-specific mounting requirements.



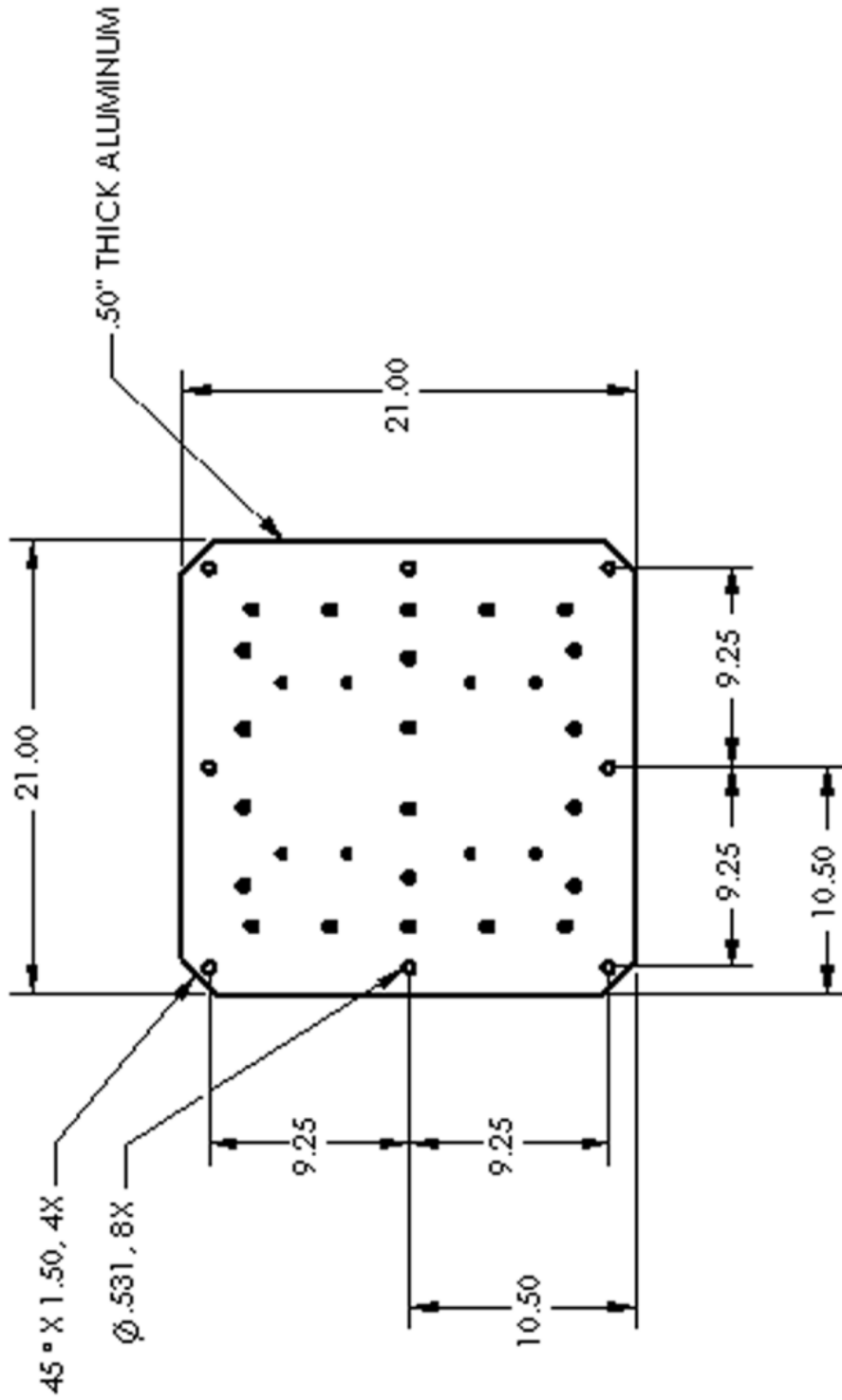

Model 3112 Mounting Pattern
Rear plate with outer hole pattern for end mounting

Connecting the Optional Positioning System

Once the Model 3112 is securely mounted on the positioner, loosen the nuts and turn the wheel at the base of the horn support for better field uniformity. This bore sights the horn 10 degrees.

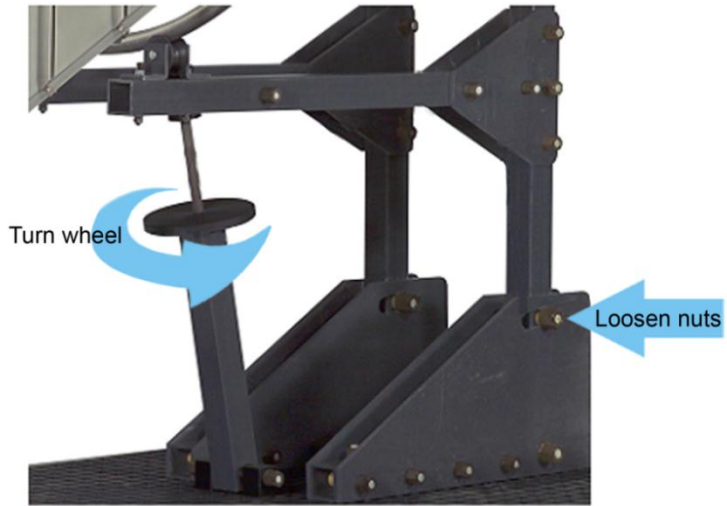

Model 3112 with optional positioner

Input Locations

CAUTION

Do not connect power to the positioner until the antenna is securely mounted and all connections have been made.

The input panel is located on the base of the Model 3112 positioner.

- Plug one end of the fiber optic cable into the **FIBER OPTIC INPUT** connector.
- Plug the opposite end of the fiber optic cable into the ETS-Lindgren Model 2090 Multi-Device Controller or compatible controller.

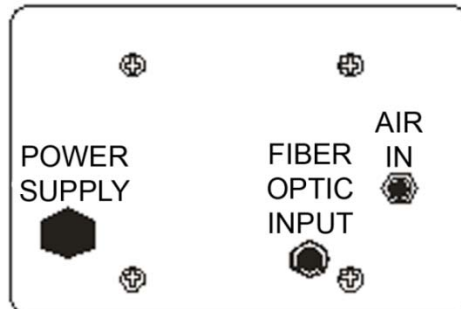

- Plug the cord included first into the **POWER SUPPLY** outlet. Make connection with the power source only once all other connections have been made and the antenna is securely attached to the positioner.

Air Polarization Option

- Plug the ends of the twin air hoses into the two **AIR OUT** connectors located on the interface box at the base of the custom positioning system.
- Plug the opposite ends of the twin hoses into the two 90 degree fittings on the air cylinder of the custom positioning system.

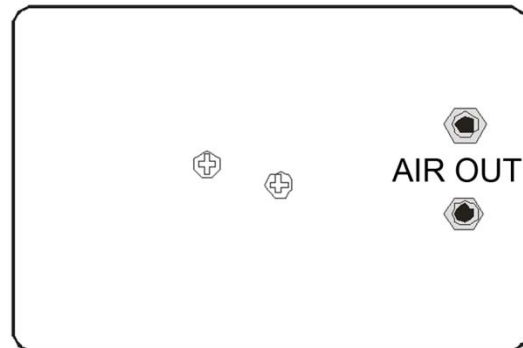

- Plug one end of the single air hose into the **AIR IN** connector located on the opposite side of the interface box at the base of the custom positioning system (shown in previous diagram).
- Plug the opposite end of the single air hose into the air supply.
- Once the antenna is completely secure and the connections are made, connect the power supply to the **POWER SUPPLY** port on the opposite side of the interface box at the base of the custom positioning system (shown in previous diagram).

6.0 Mounting a Model 3106 Series Antenna to a 7-TR

CAUTION

Before connecting any components or operating the Double-Ridged Waveguide Horn Antennas, follow the safety information in the ETS-Lindgren *Product Information Bulletin* included with your shipment.

CAUTION

You will need assistance from two team members to mount a Model 3106 Series antenna to the 7-TR.



You must install the 108507 boom onto the 7-TR before performing these steps. For clarity, the following illustrations do not show the 7-TR.



ETS-Lindgren may substitute a similar part with the same functionality for another part (for example, a wingnut for a hex nut).

The following steps to mount a Model 3106B Double-Ridged Waveguide Horn Antenna onto a 108507 boom apply to all Model 3106 Series antennas.

Step 1

Remove the two 104136 boom knobs from the underside of the 108507 boom. You will re-use the knobs in Step 7.

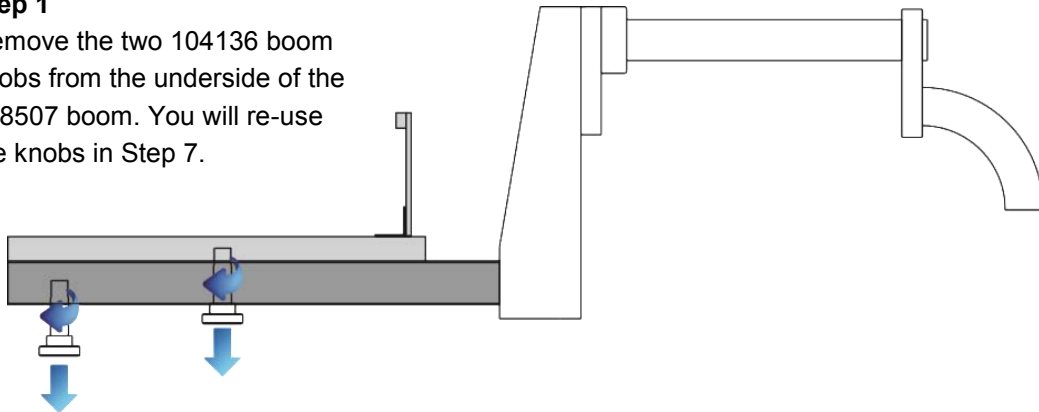

Step 2

Lift the mount adapter up and away from the boom.

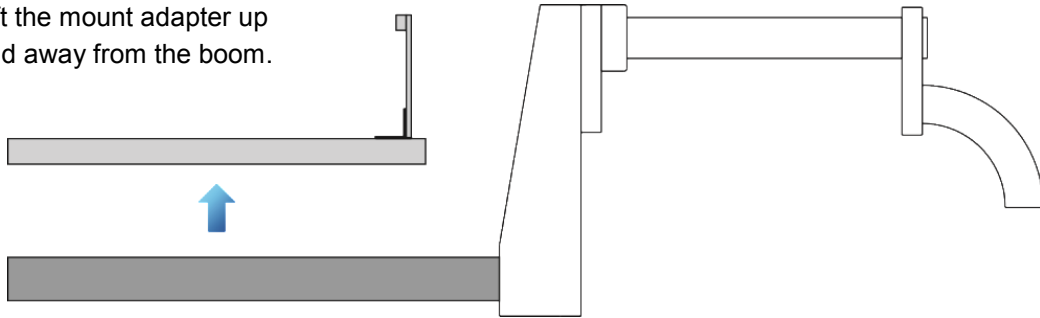

Step 3

Remove the wingnut to free the 1/4–20 screw from the mount adapter. You will re-use the screw in Step 6.

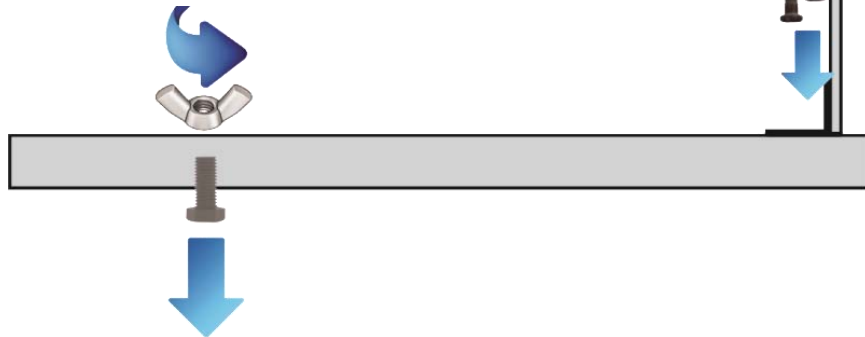

Step 4

Remove the nuts to free the two screws from the vertical plate on the mount adapter. You will re-use the screws in Step 6.



Step 5

On the side of the Model 3106B with the antenna connector, remove the two screws from the mount plate.

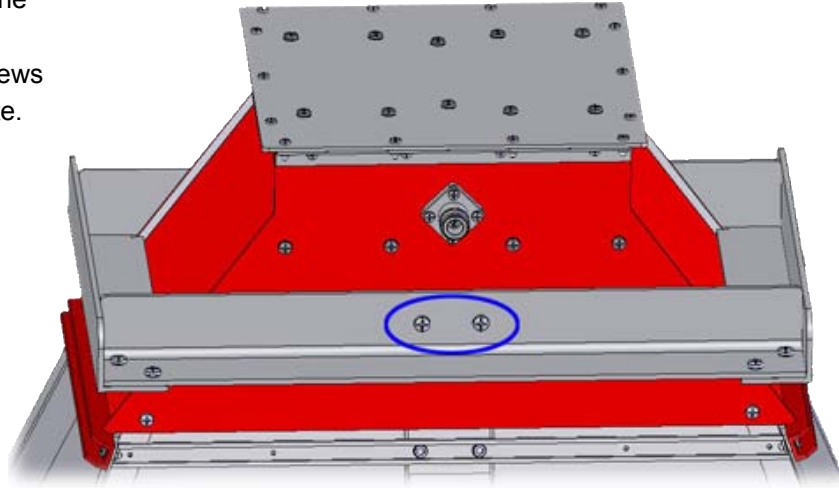

Retain these two screws for future use; if you remove the Model 3106B from the 7-TR, you will need to replace these screws to provide support for the inner ridge of the antenna.

Step 6

Attach mount adapter to the Model 3106B:

- Using the two screws removed in Step 4, insert the screws through the lip on the vertical part of the mount adapter and into the two holes on the antenna. Tighten to secure.
- Using the screw removed in Step 3, insert the screw through the horizontal part of the mount adapter and into the mount block on the antenna. Tighten to secure.

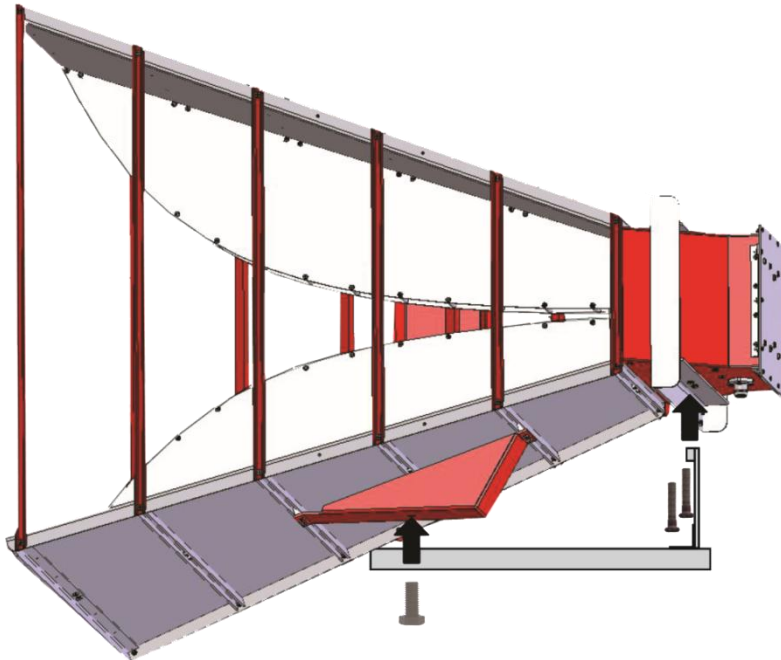

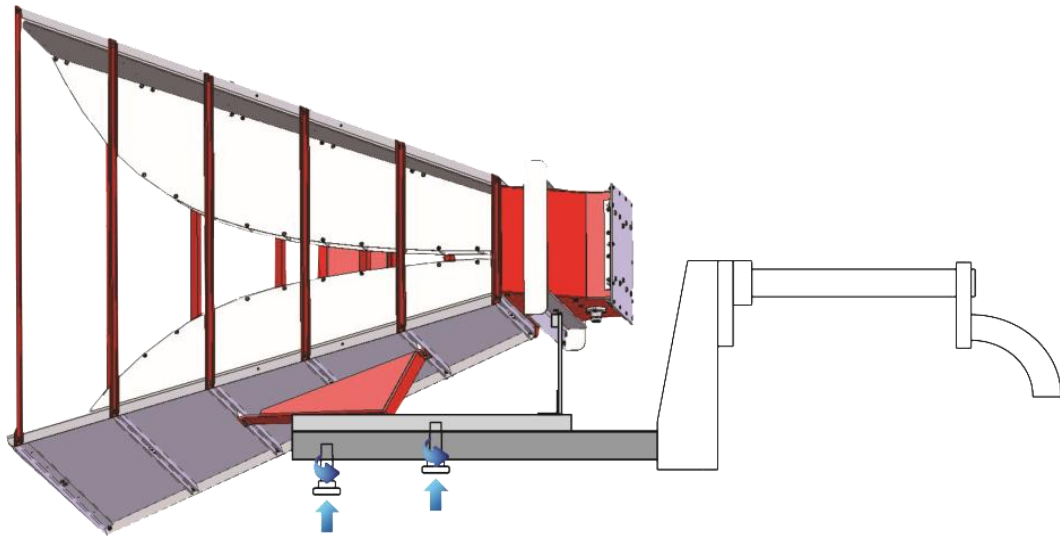

Step 7

Attach the mounted assembly to the boom: Use the two 104136 knobs removed in Step 1 to attach the antenna and mount adapter assembly to the boom. Tighten to secure.

7.0 Typical Data

CAUTION

Before placing into operation, follow the safety information in the ETS-Lindgren *Product Information Bulletin* included with your shipment.

Model 3112

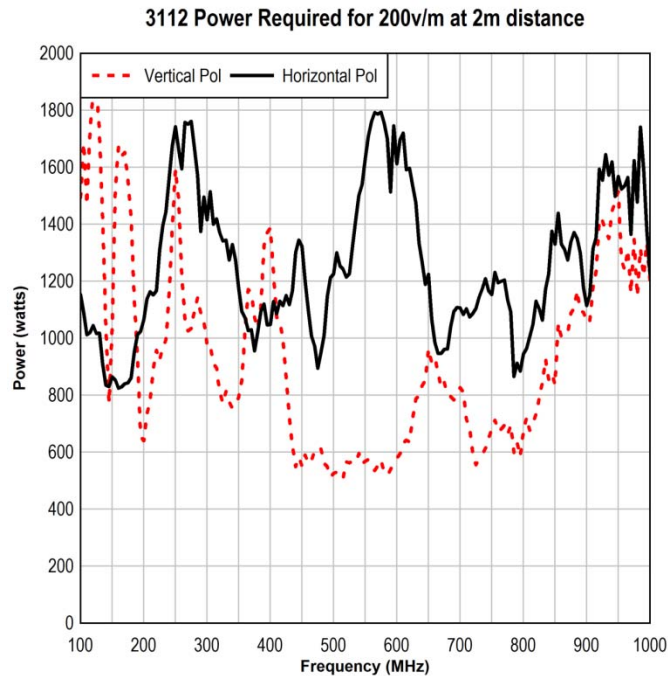
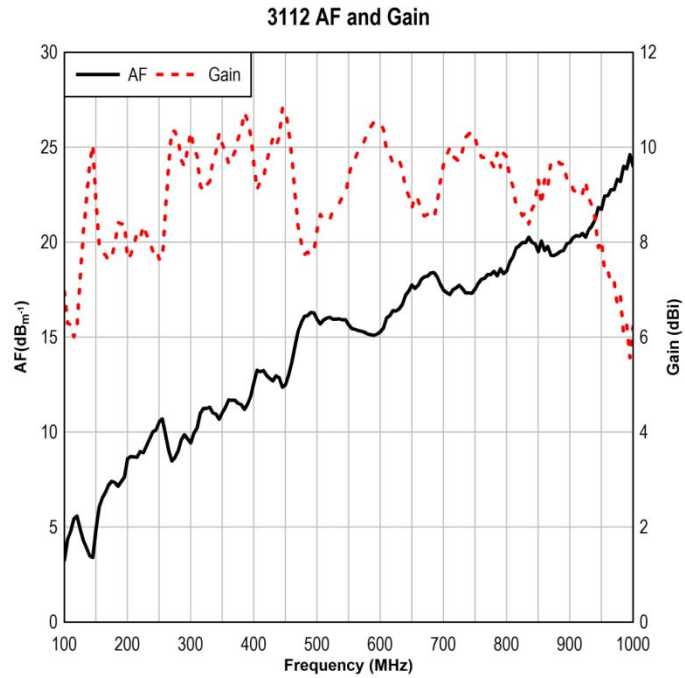

3112VSWR

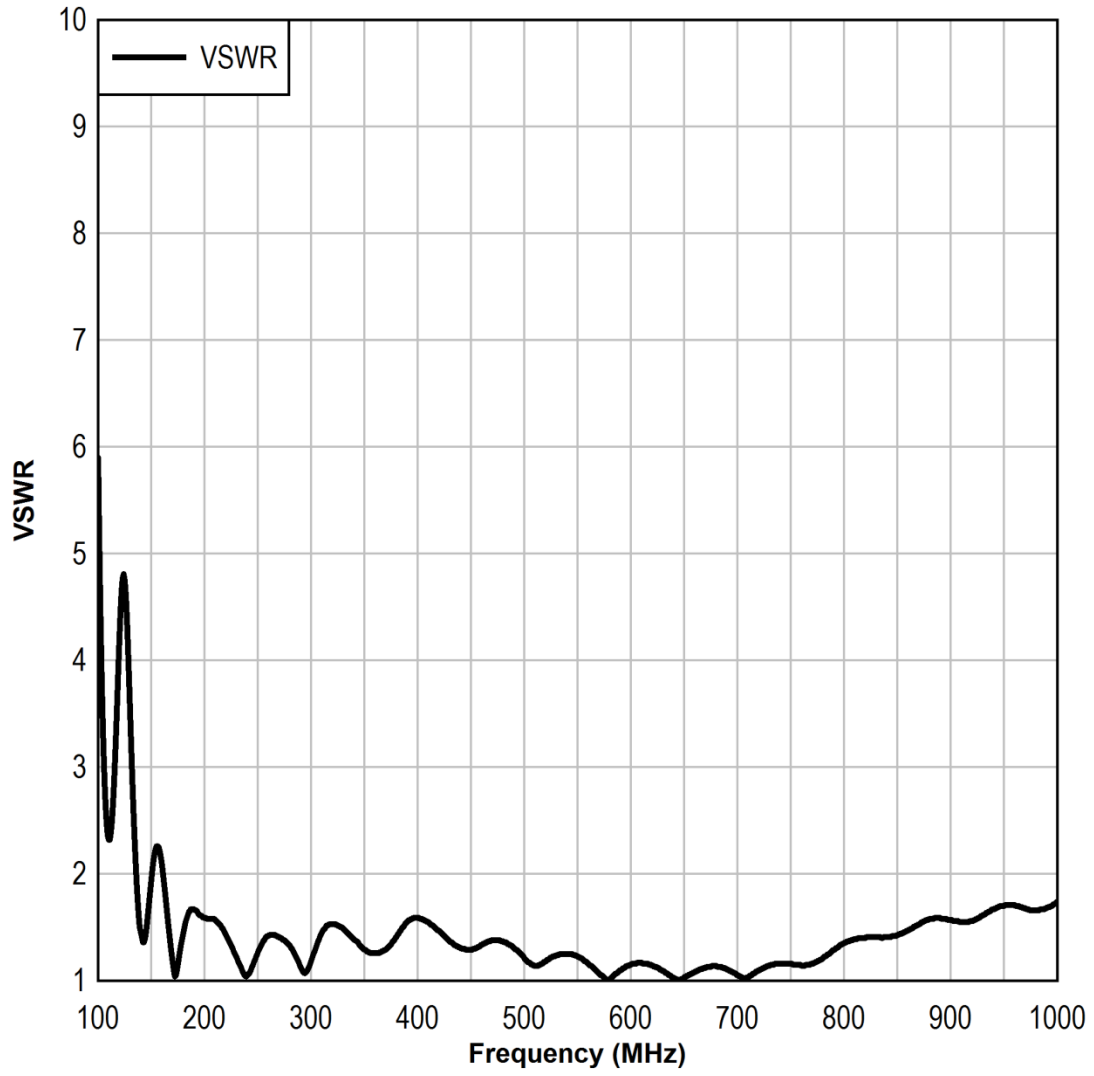

3106B AF and Gain

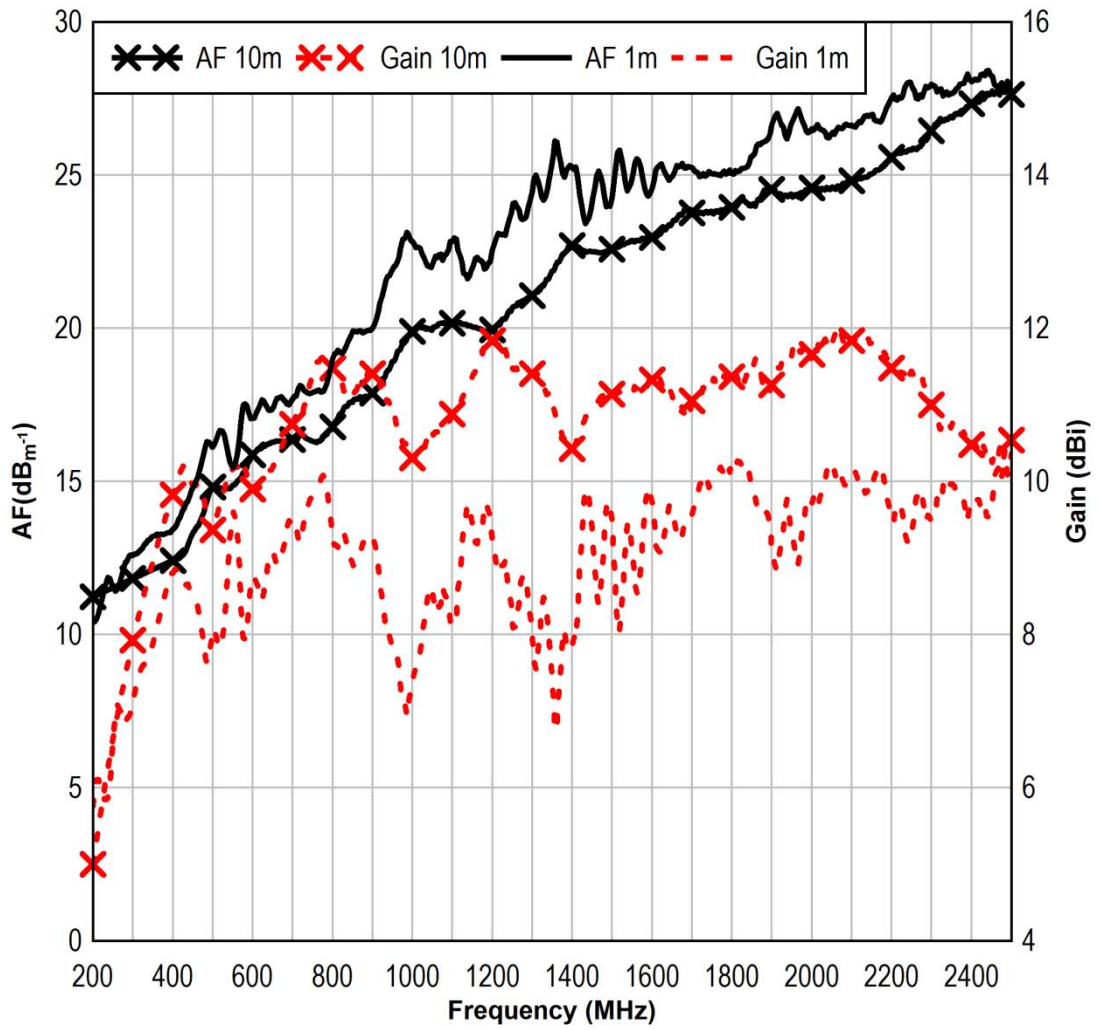

3106B Half Power Beamwidth

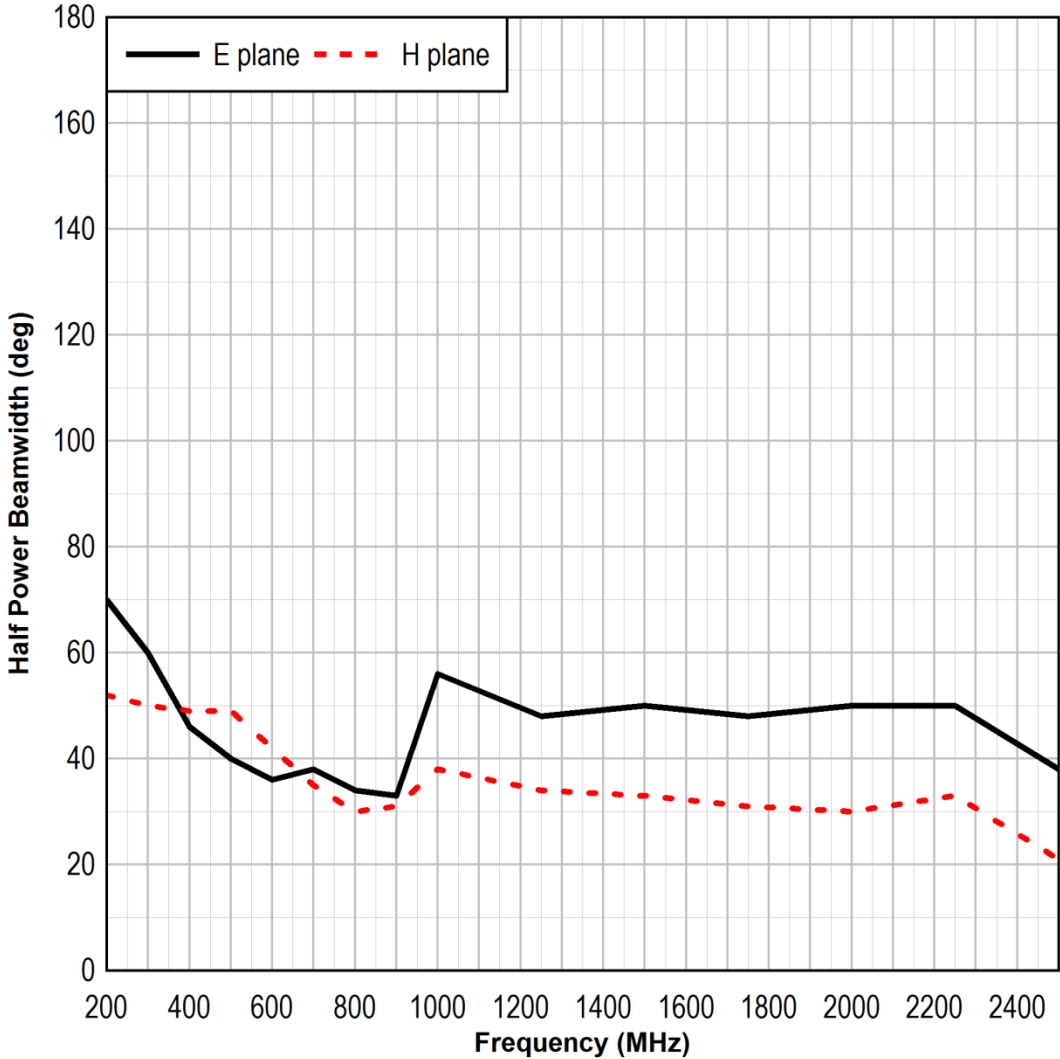

3119 AF and Gain

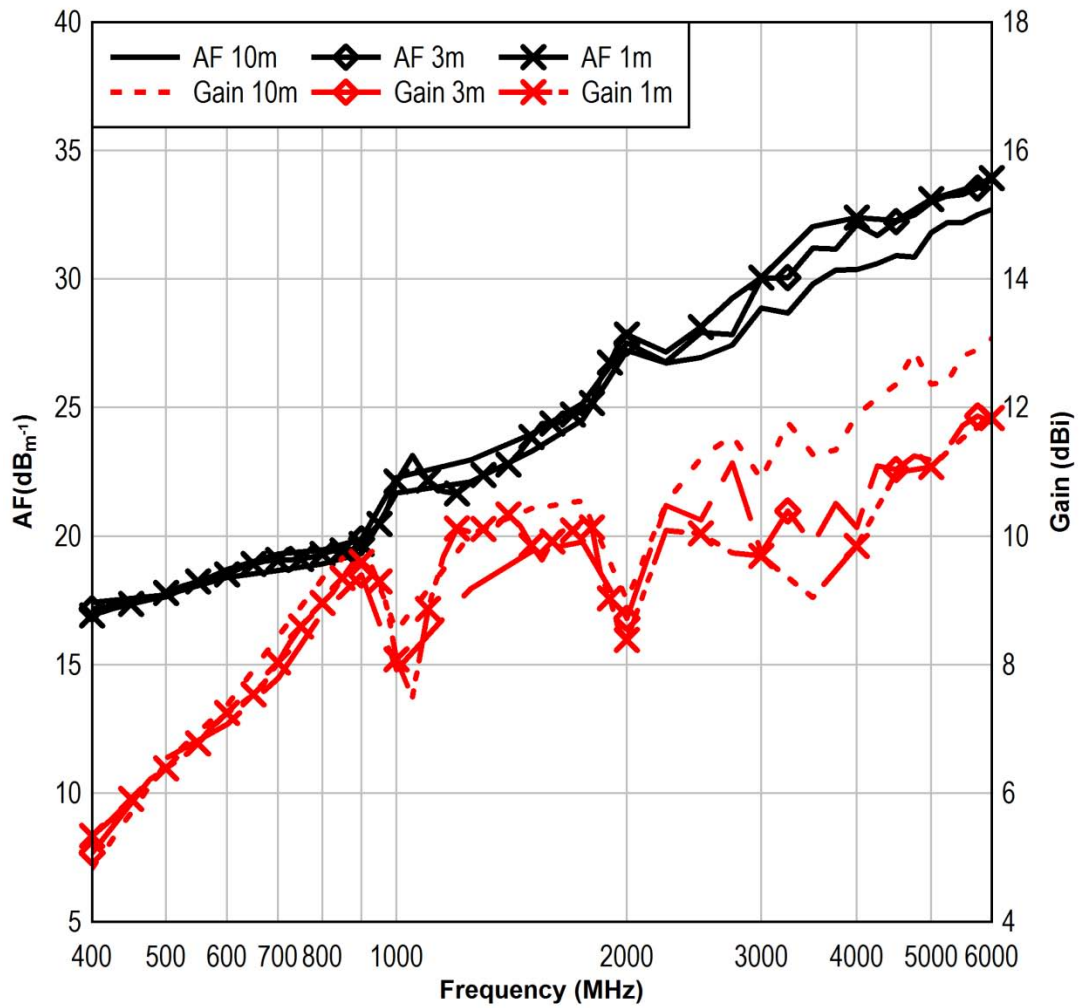

3119 Half Power Beamwidth

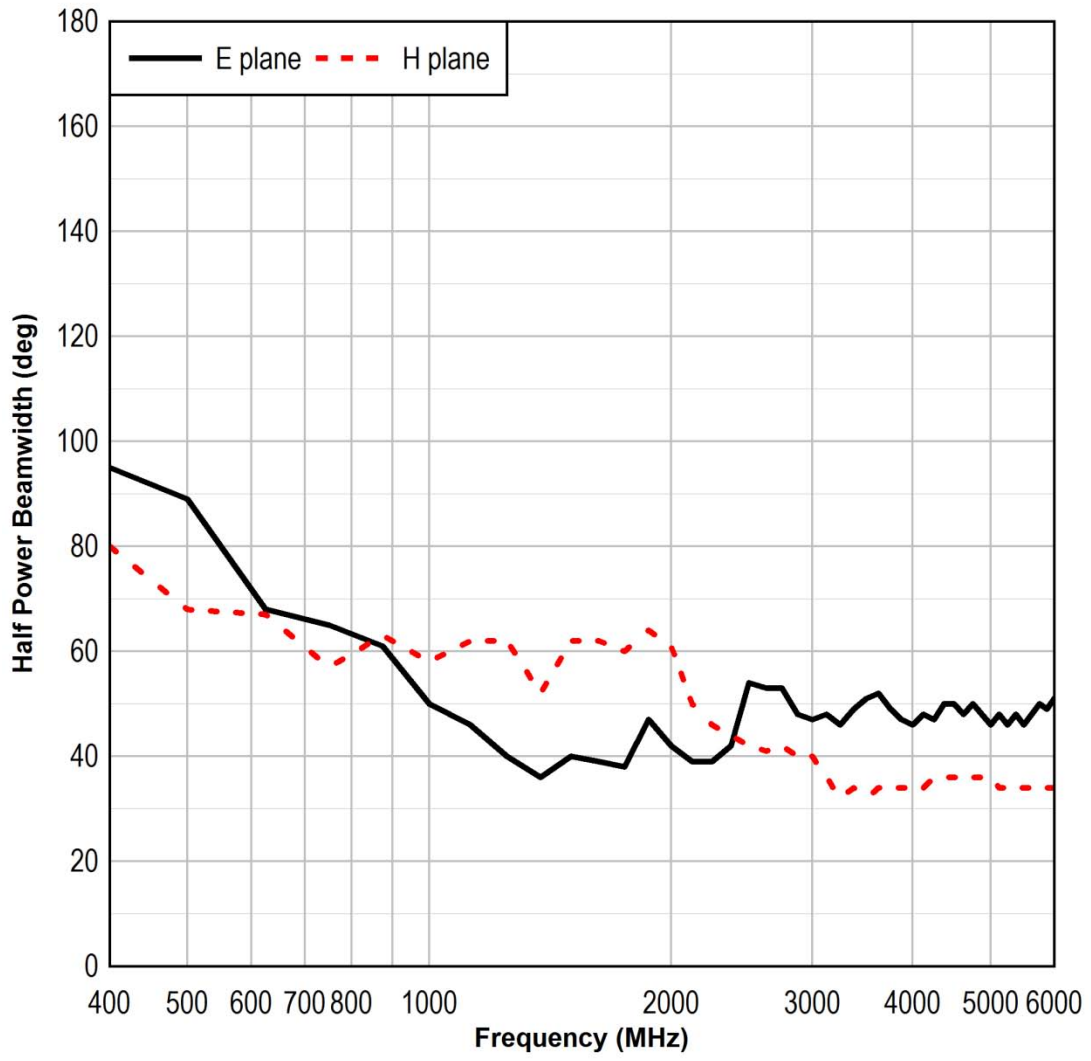

3119 VSWR

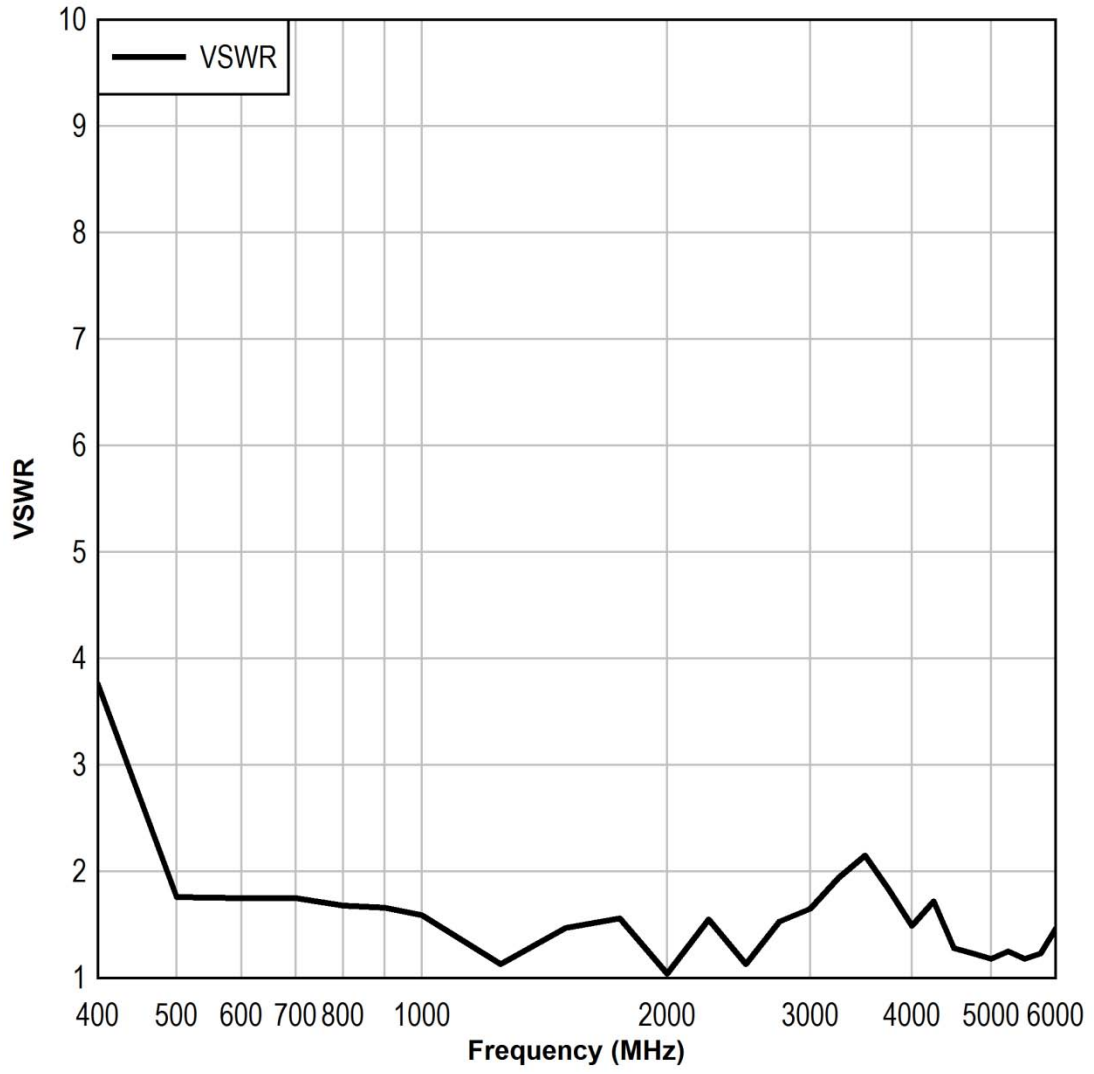

3115 AF and Gain

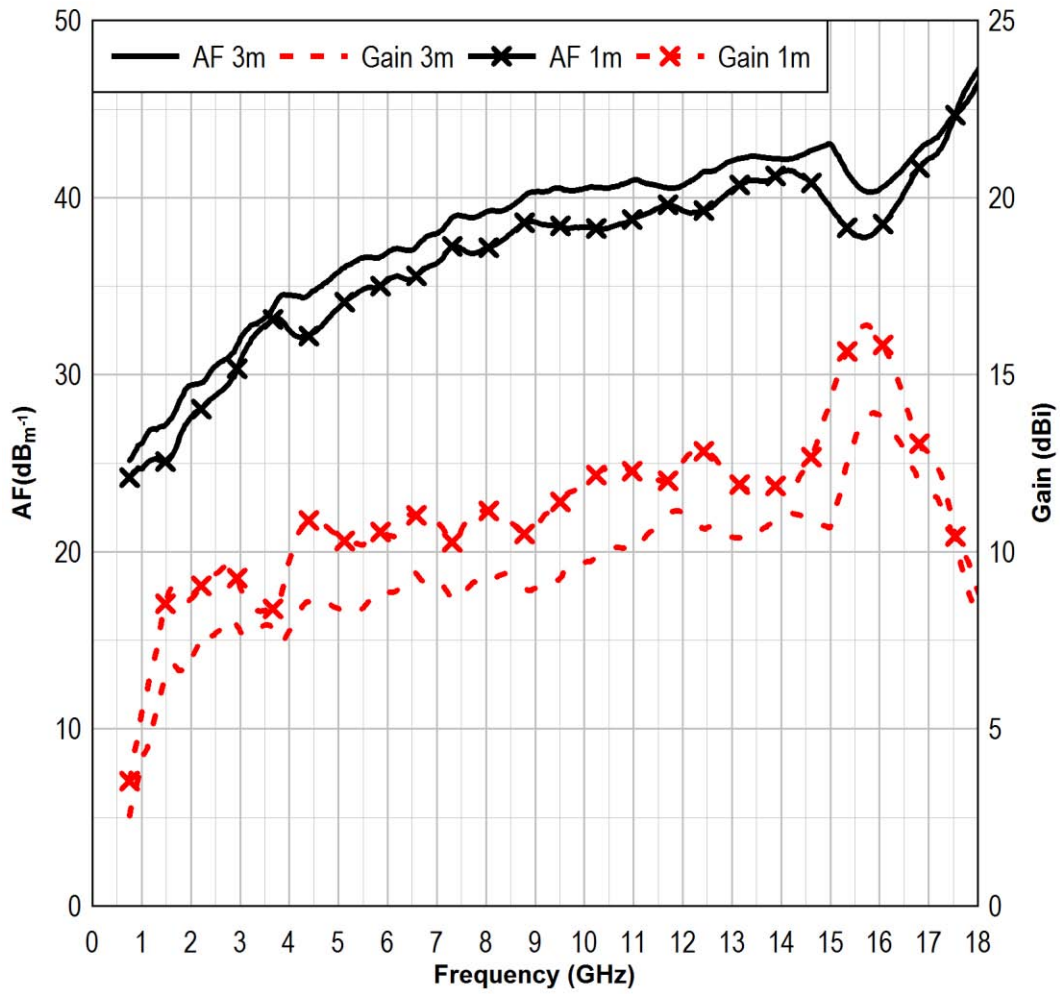

3115 Half Power Beamwidth

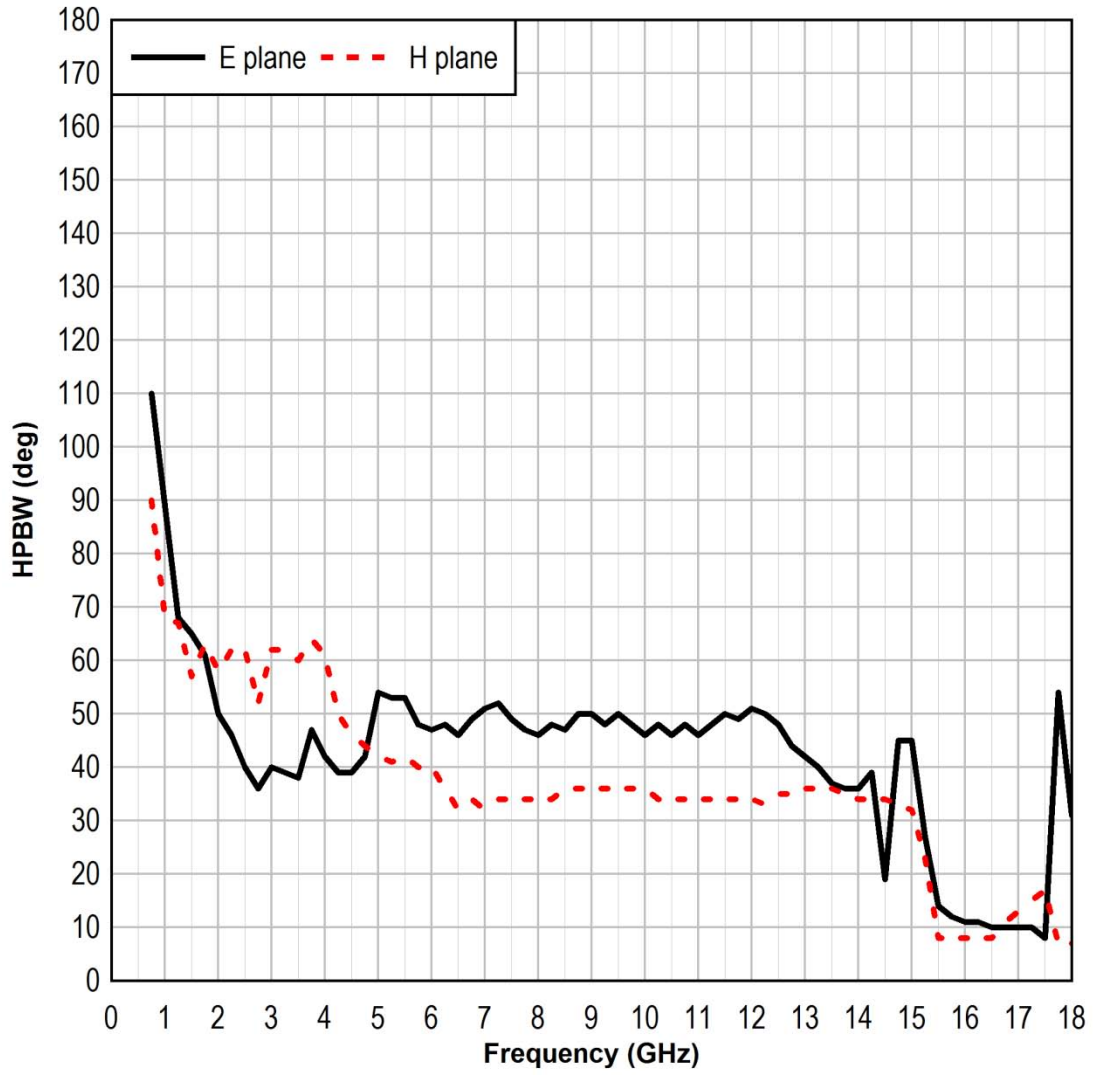

3115 VSWR

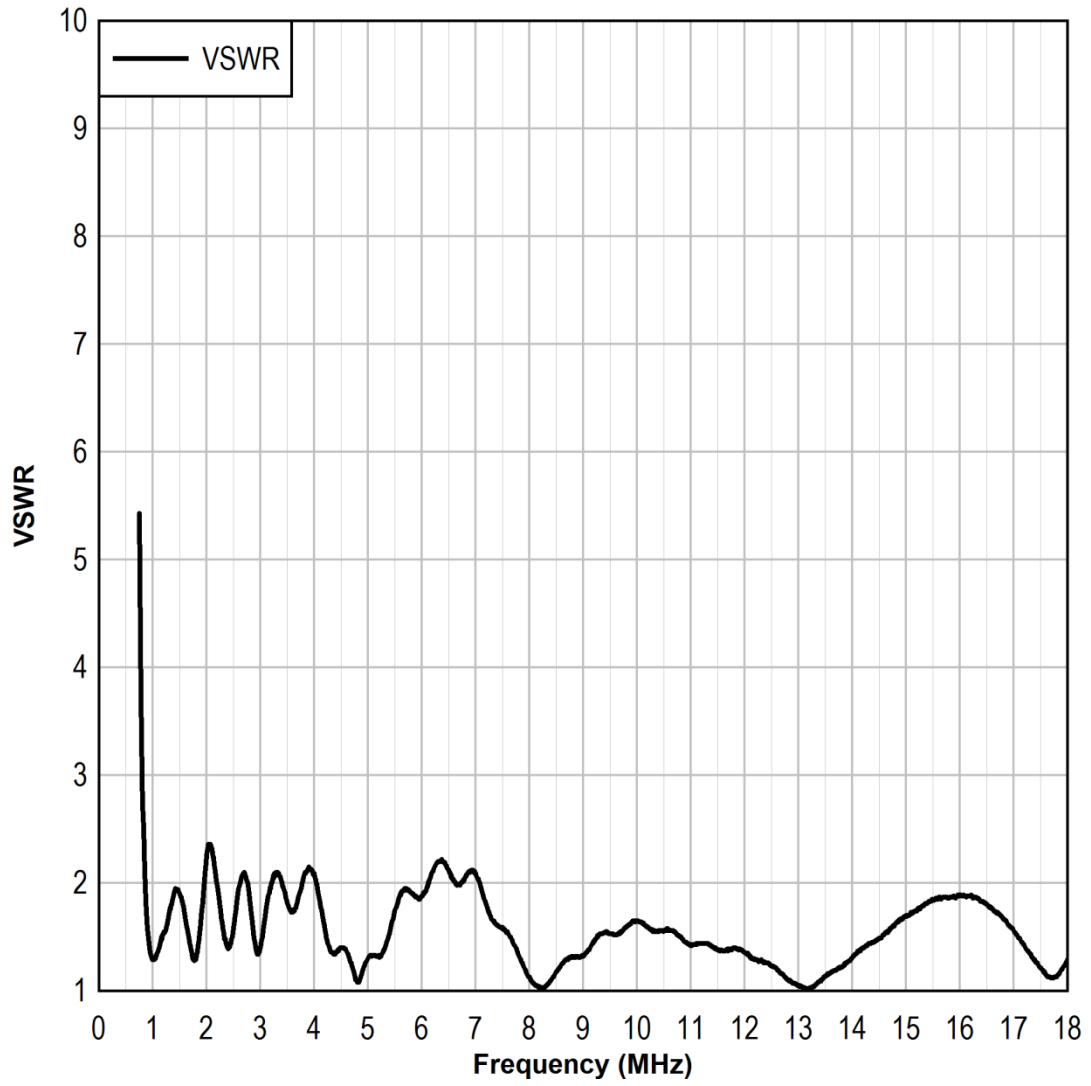

3117 AF and Gain

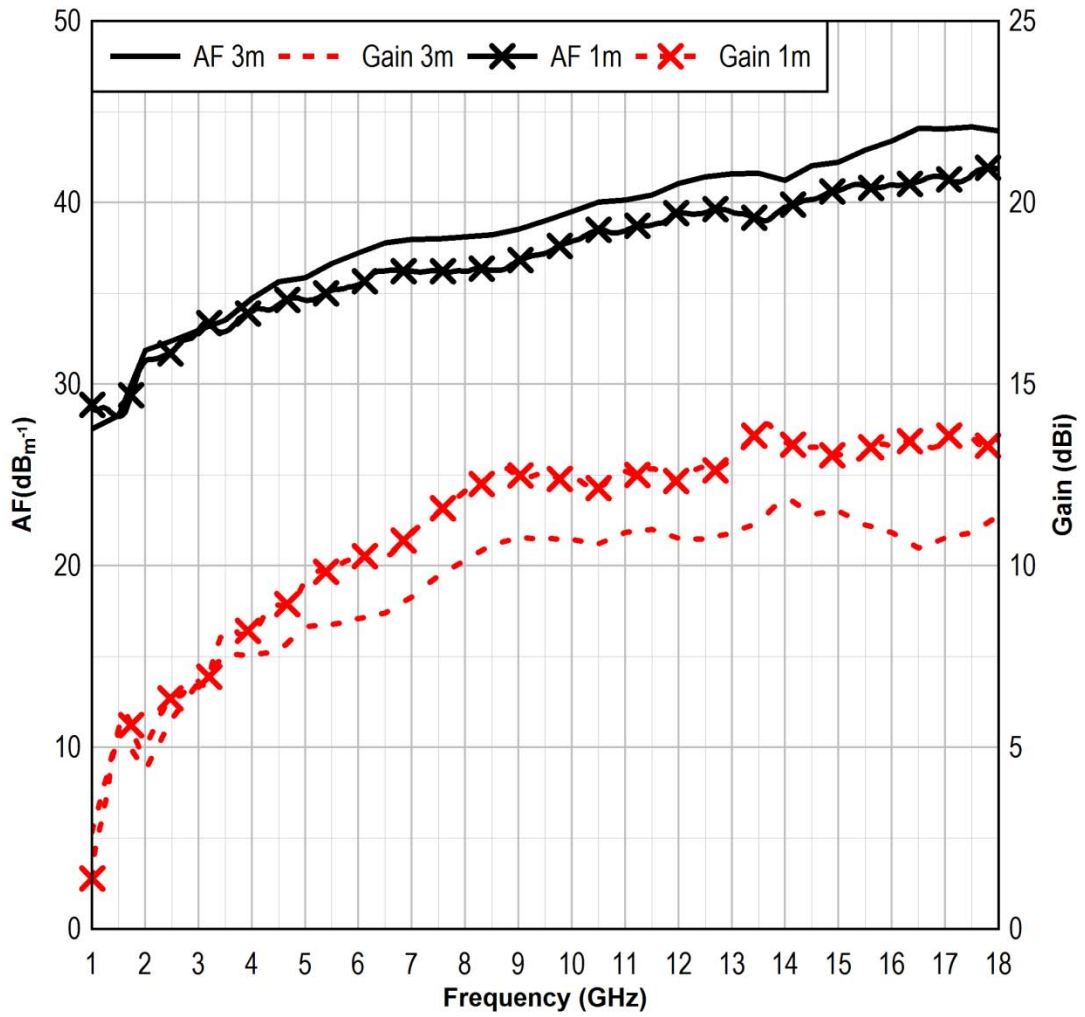

3117 Half Power Beamwidth

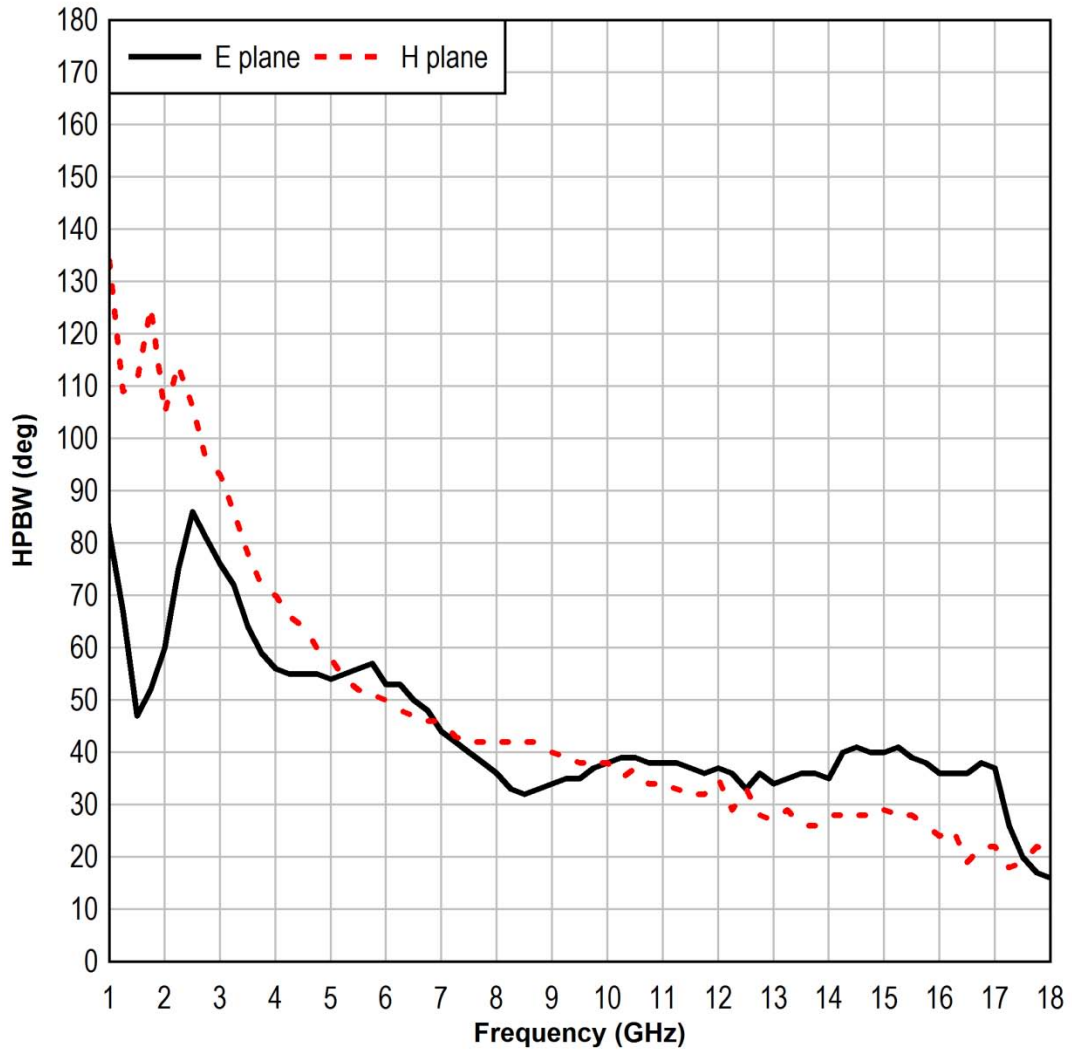

3117 VSWR

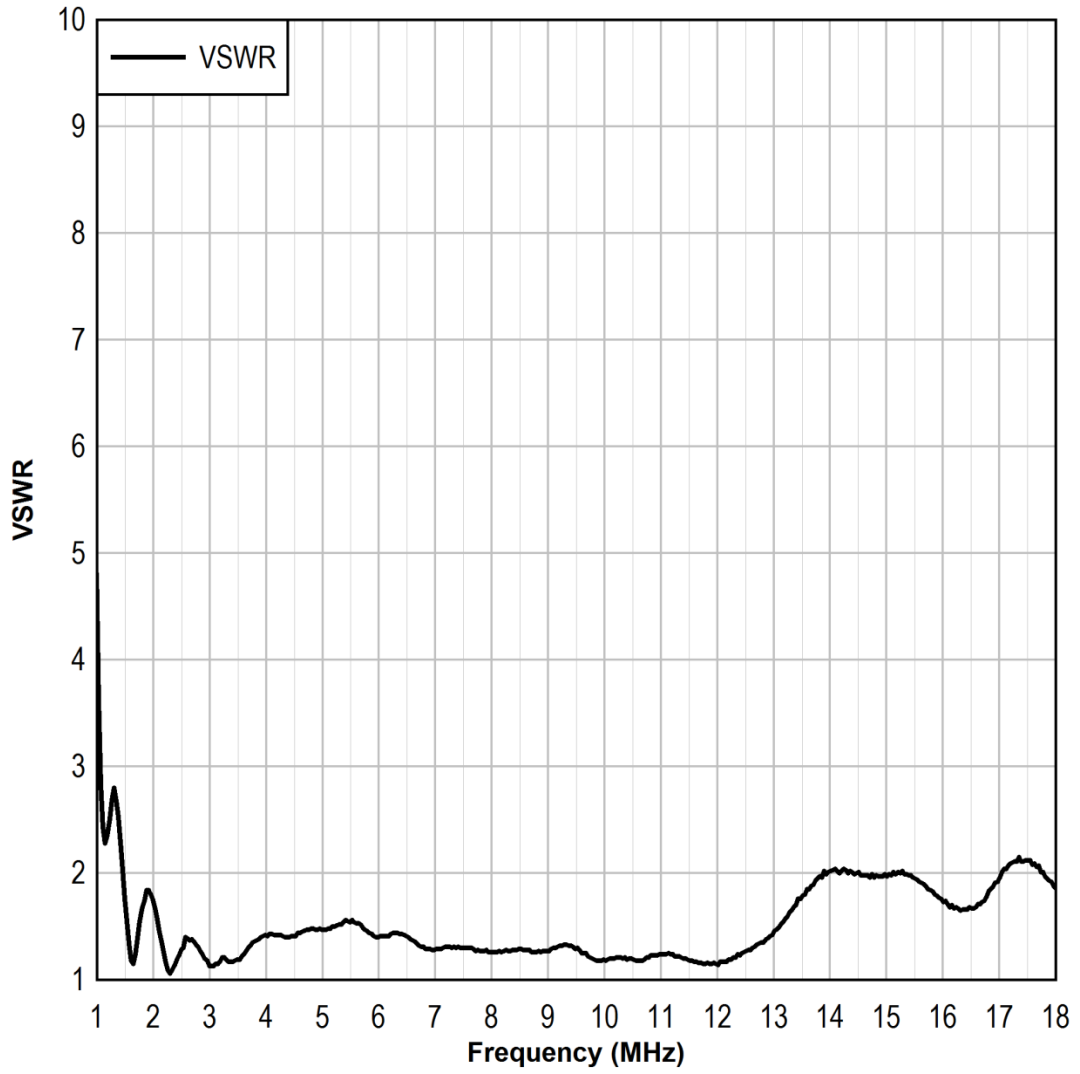

3116C AF and Gain

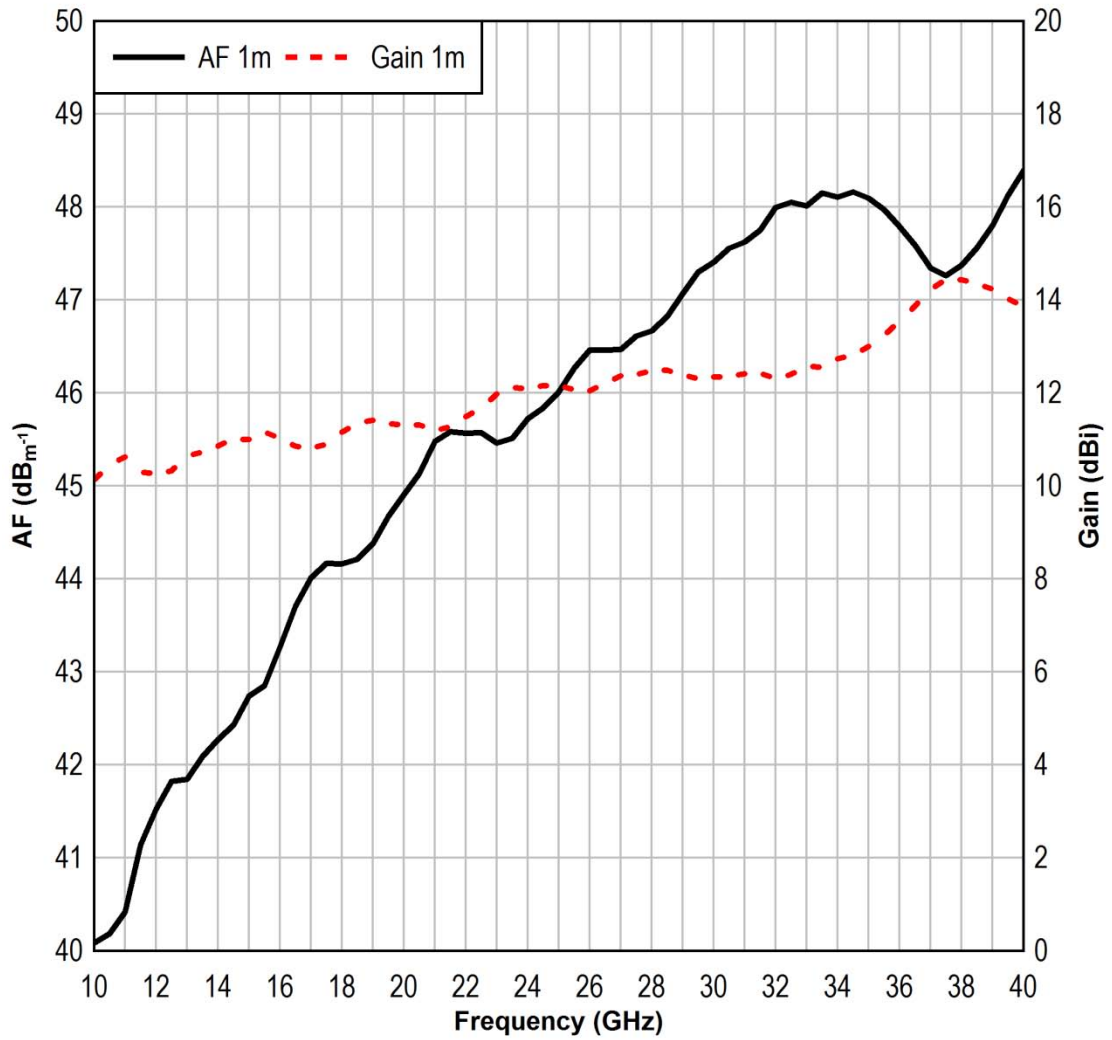

3116C Half Power Beamwidth (computed)

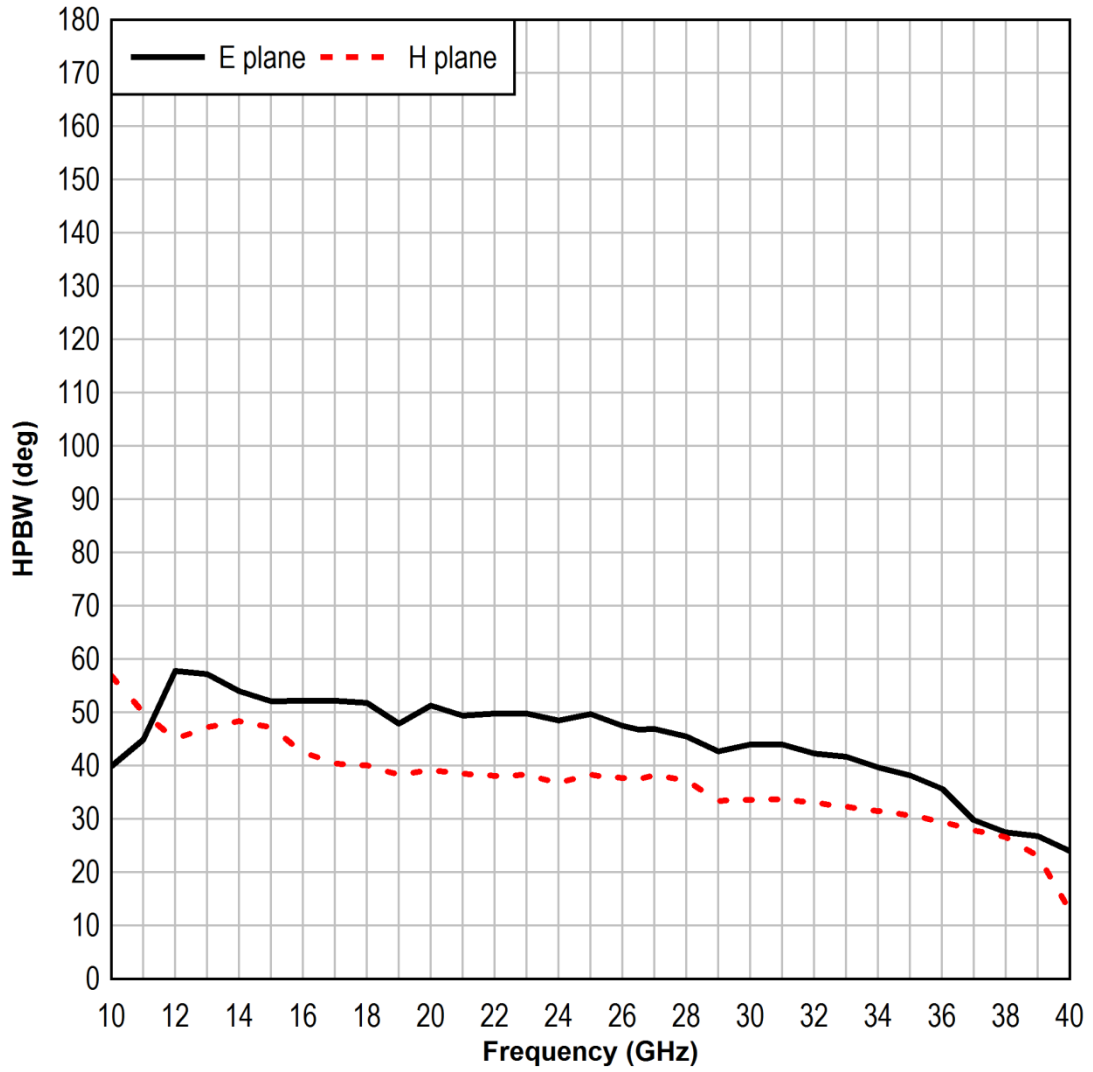

3116C VSWR

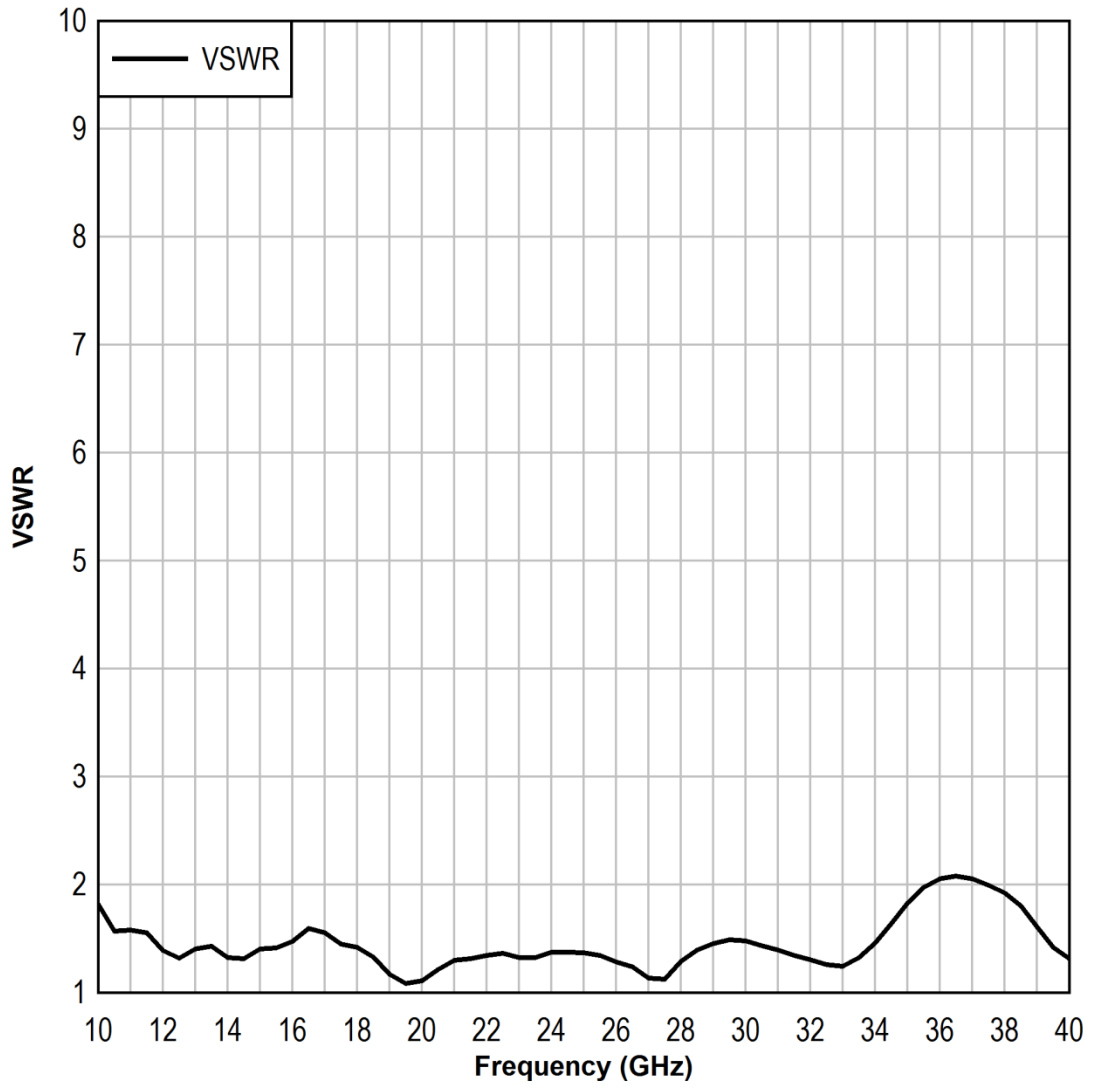

Appendix A: Warranty



See the *Product Information Bulletin* included with your shipment for the complete ETS-Lindgren warranty for your Double-ridged Waveguide Horn Antenna.

DURATION OF WARRANTIES FOR DOUBLE-RIDGED WAVEGUIDE HORN ANTENNAS

All product warranties, except the warranty of title, and all remedies for warranty failures are limited to two years.

Product Warranted	Duration of Warranty Period
Model 3112	2 Years
Model 3106B	2 Years
Model 3119	2 Years
Model 3115	2 Years
Model 3117	2 Years
Model 3116C	2 Years

This page intentionally left blank.

Appendix B: Typical Measured Radiated Patterns

Model 3106B

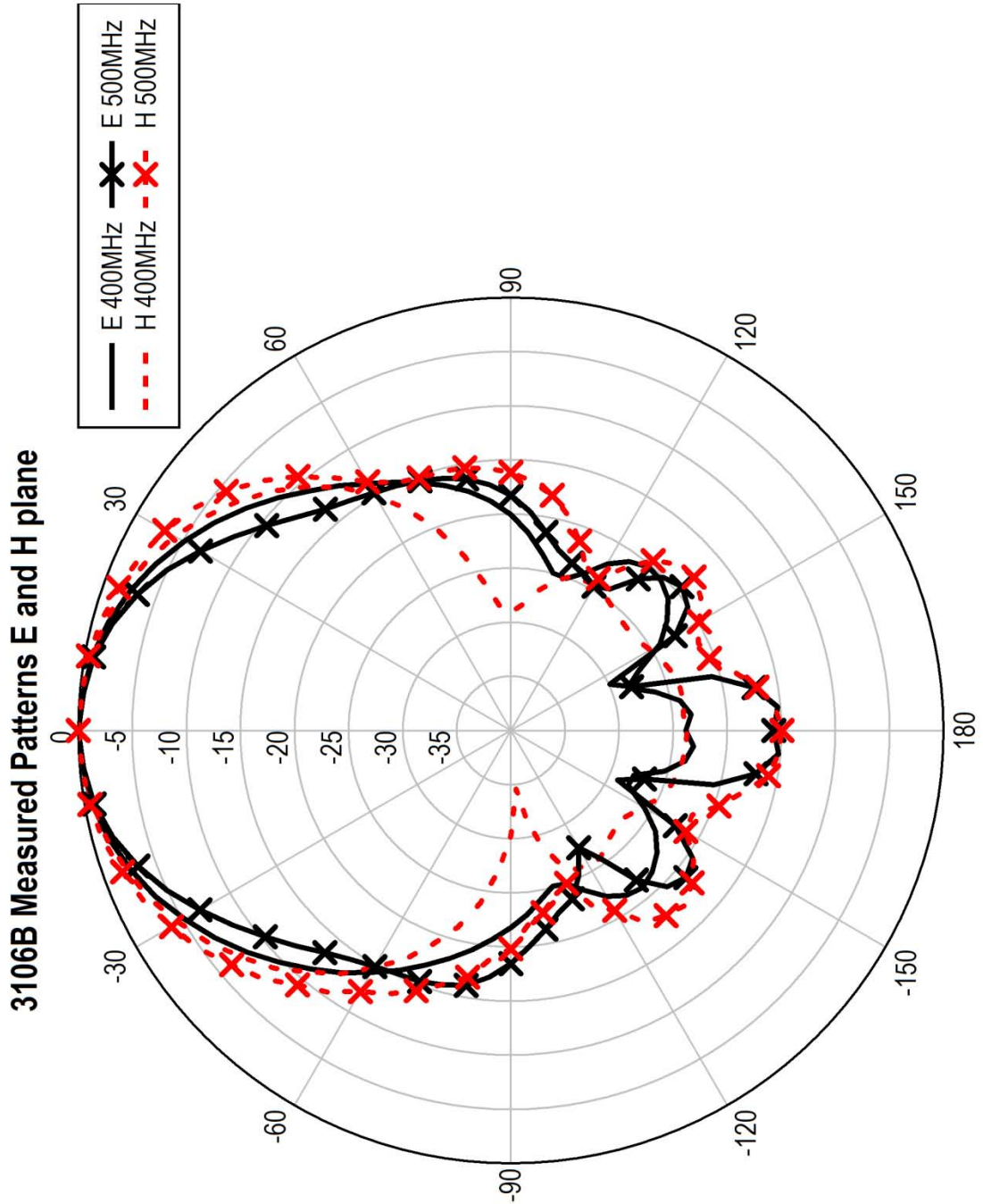

3106B Measured Patterns E and H plane

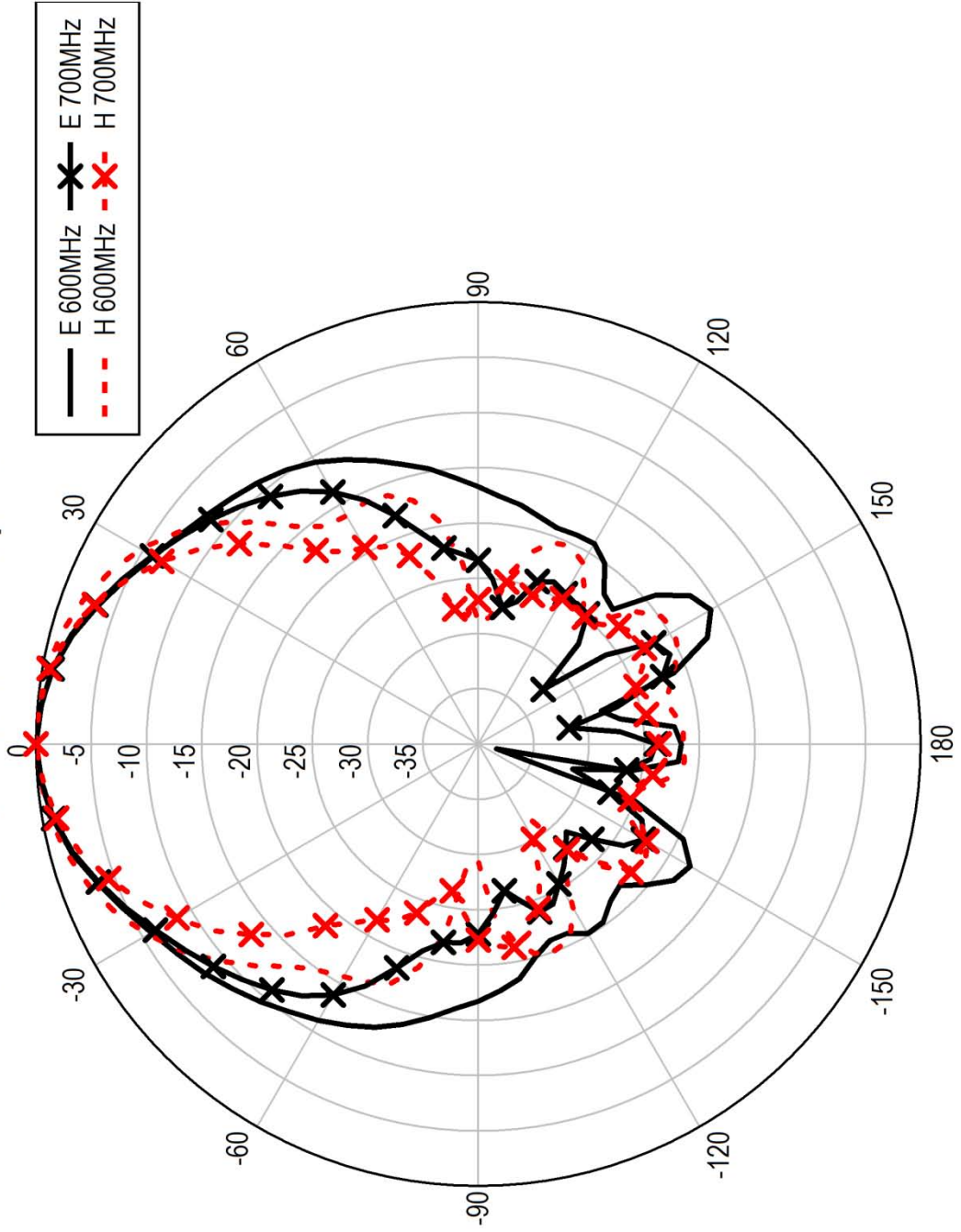

3106B Measured Patterns E and H plane

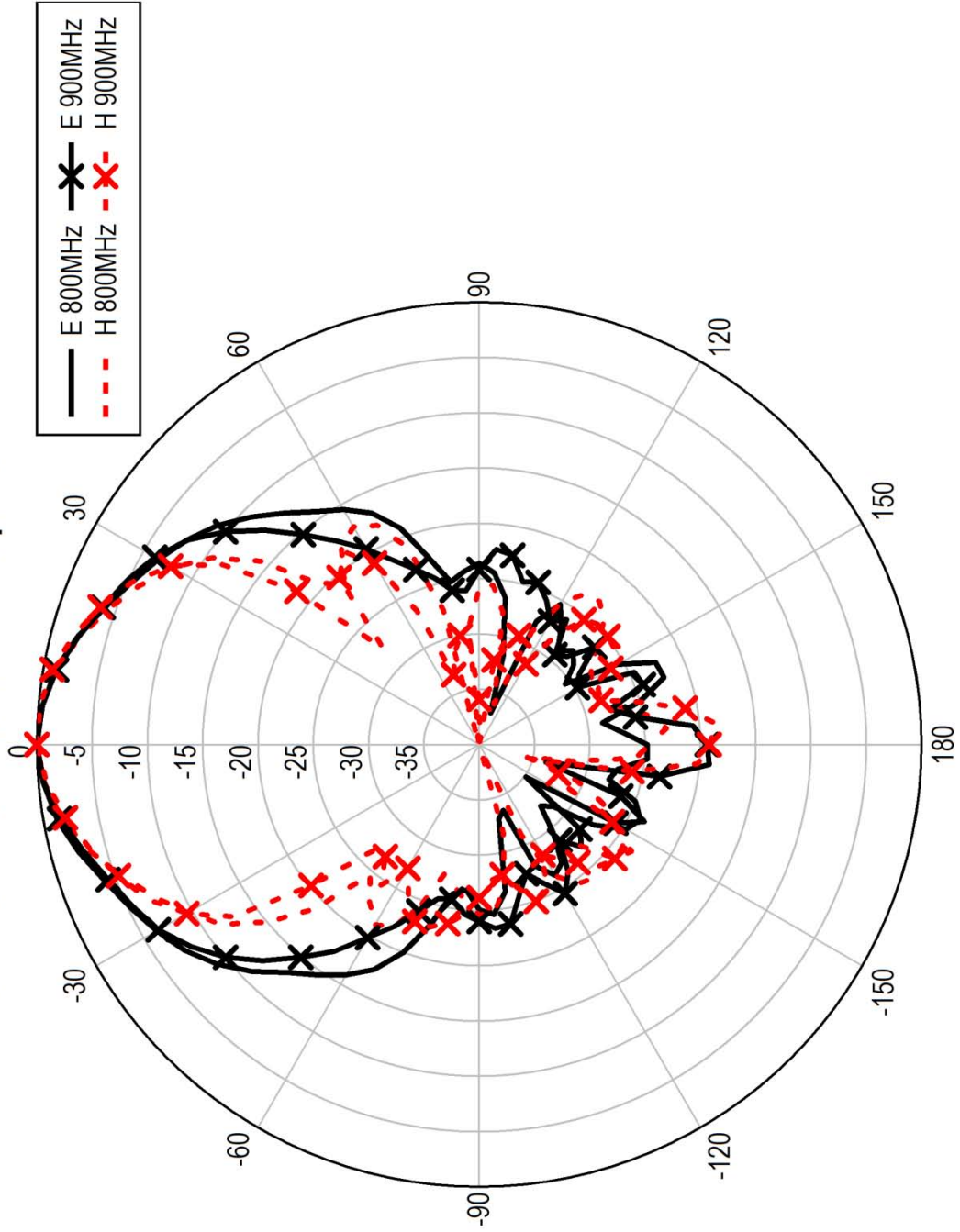

3106B Measured Patterns E and H plane

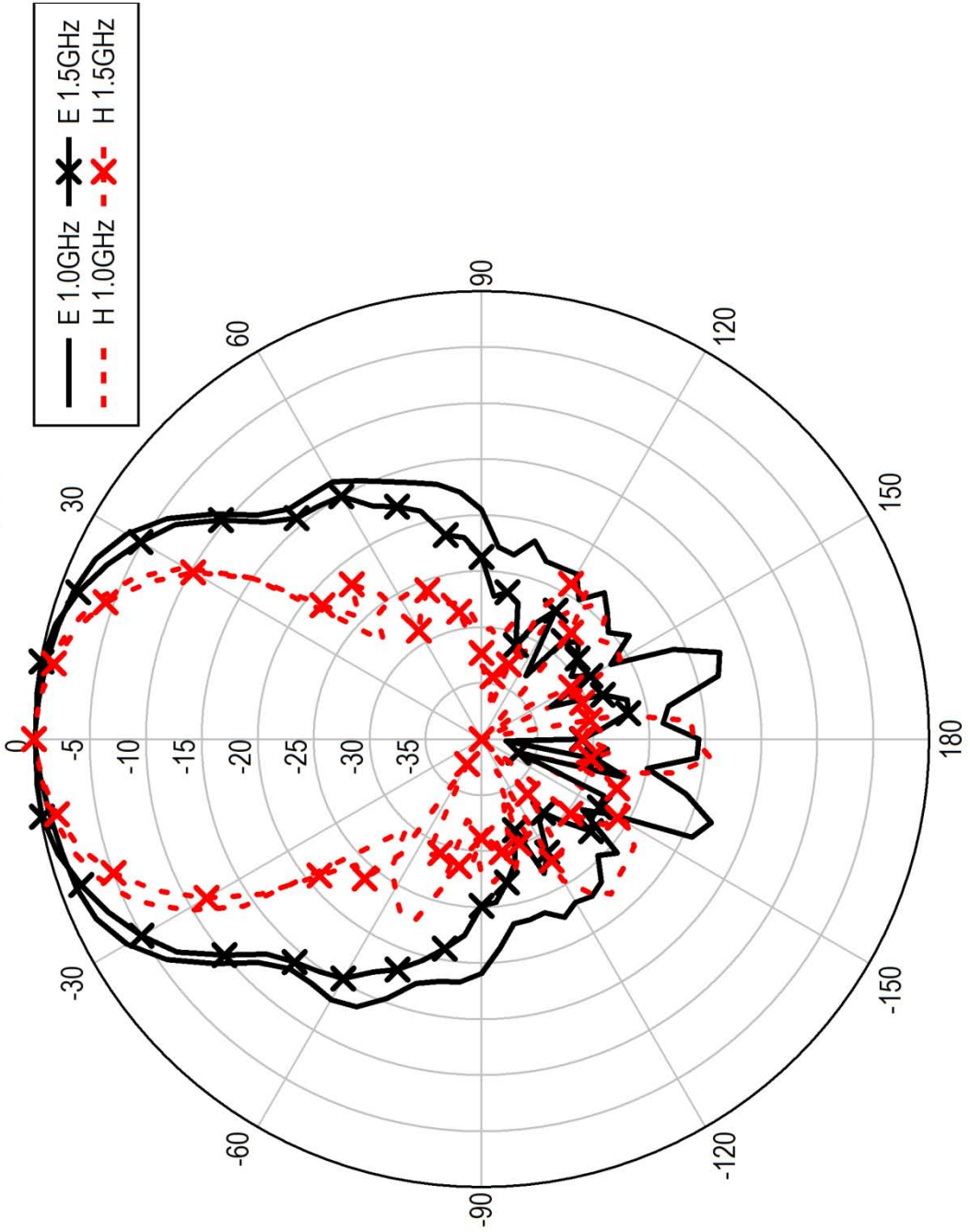

3106B Measured Patterns E and H plane

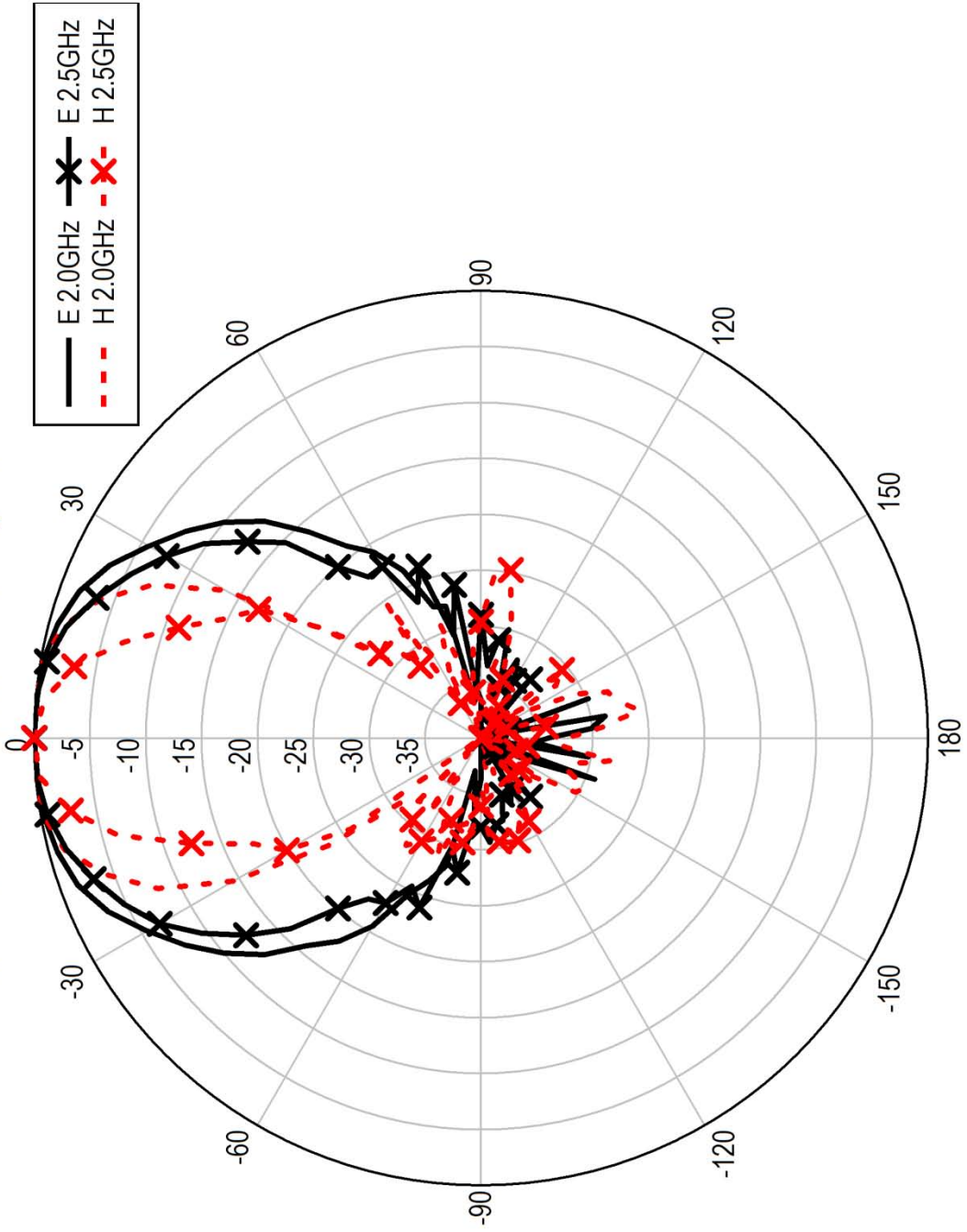

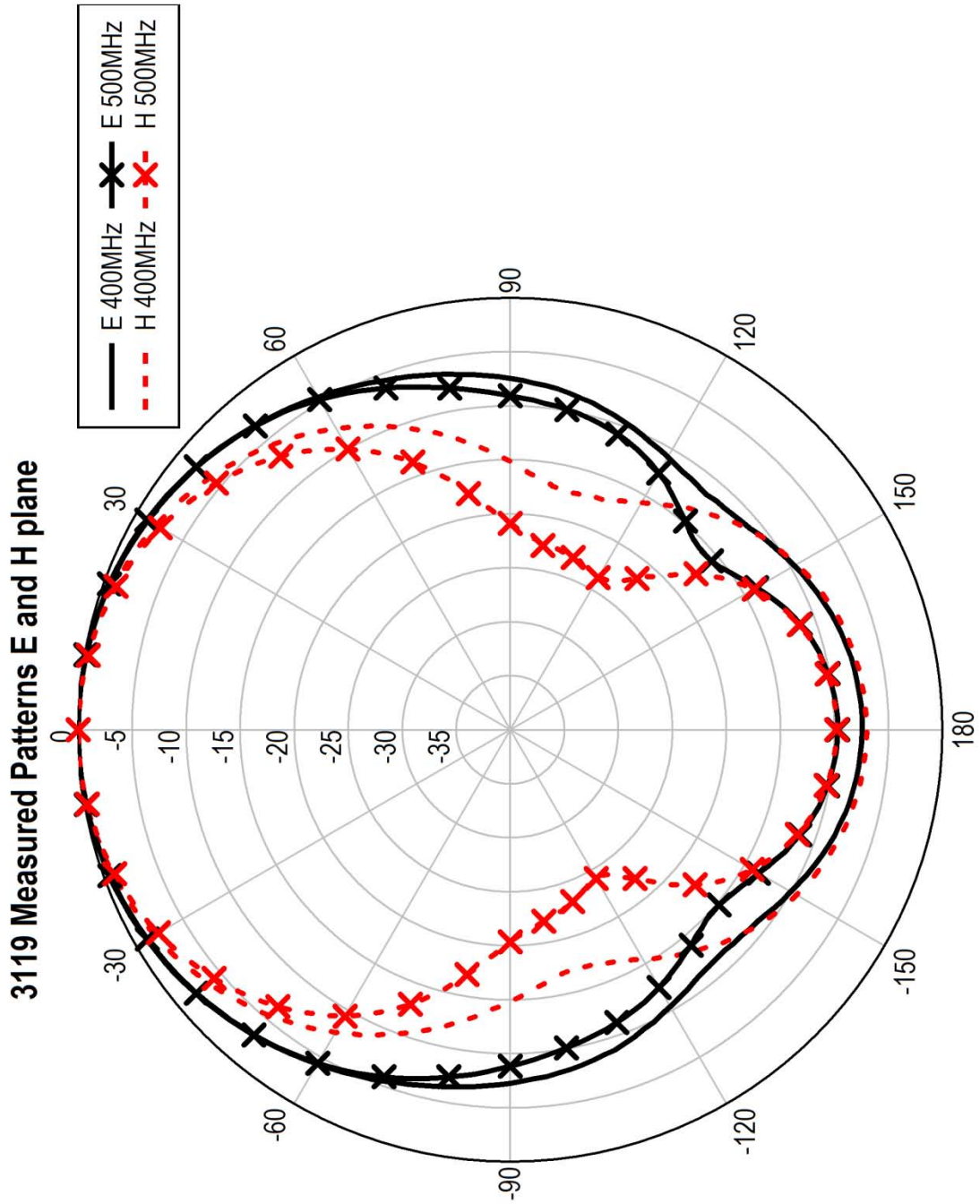

3119 Measured Patterns E and H plane

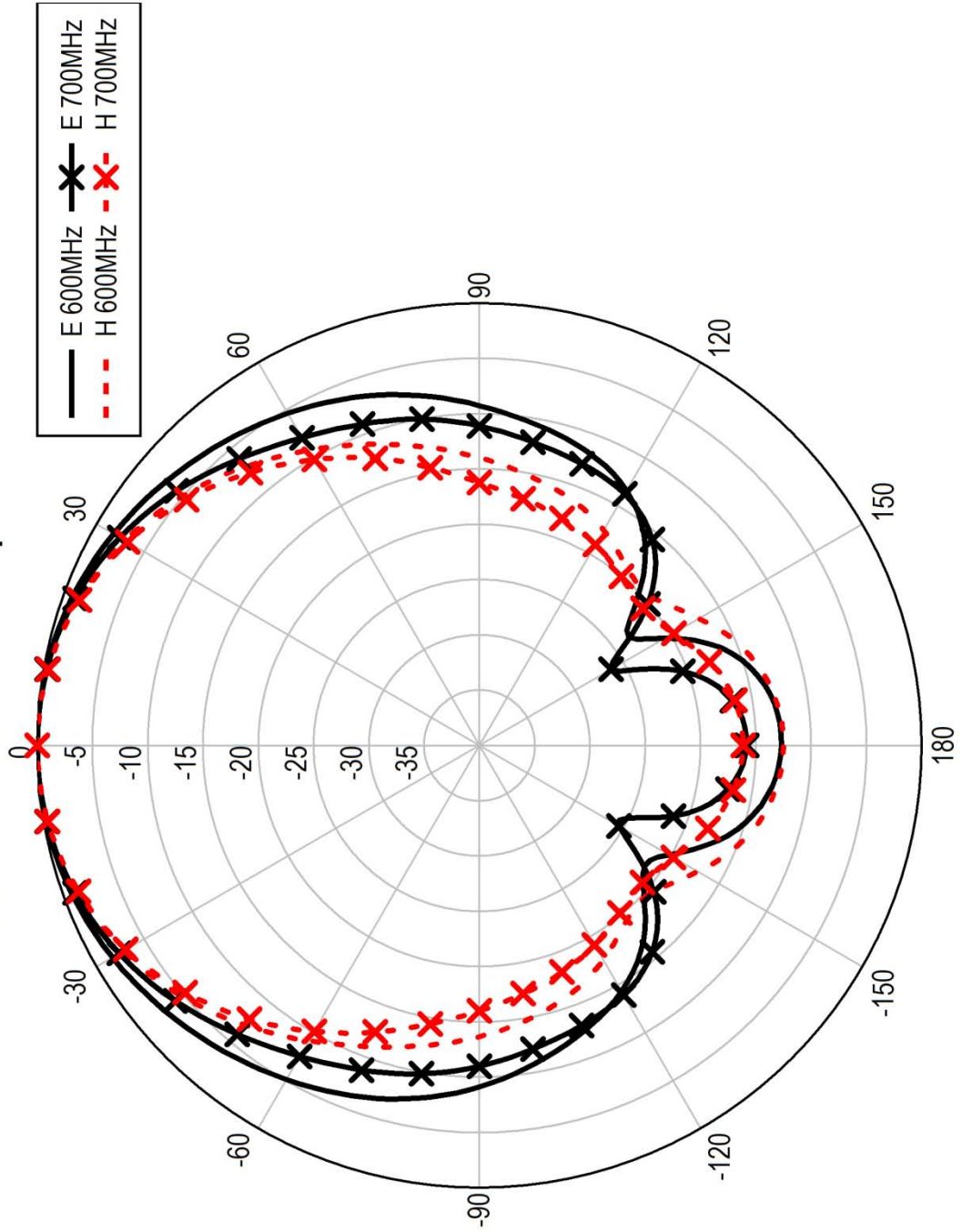

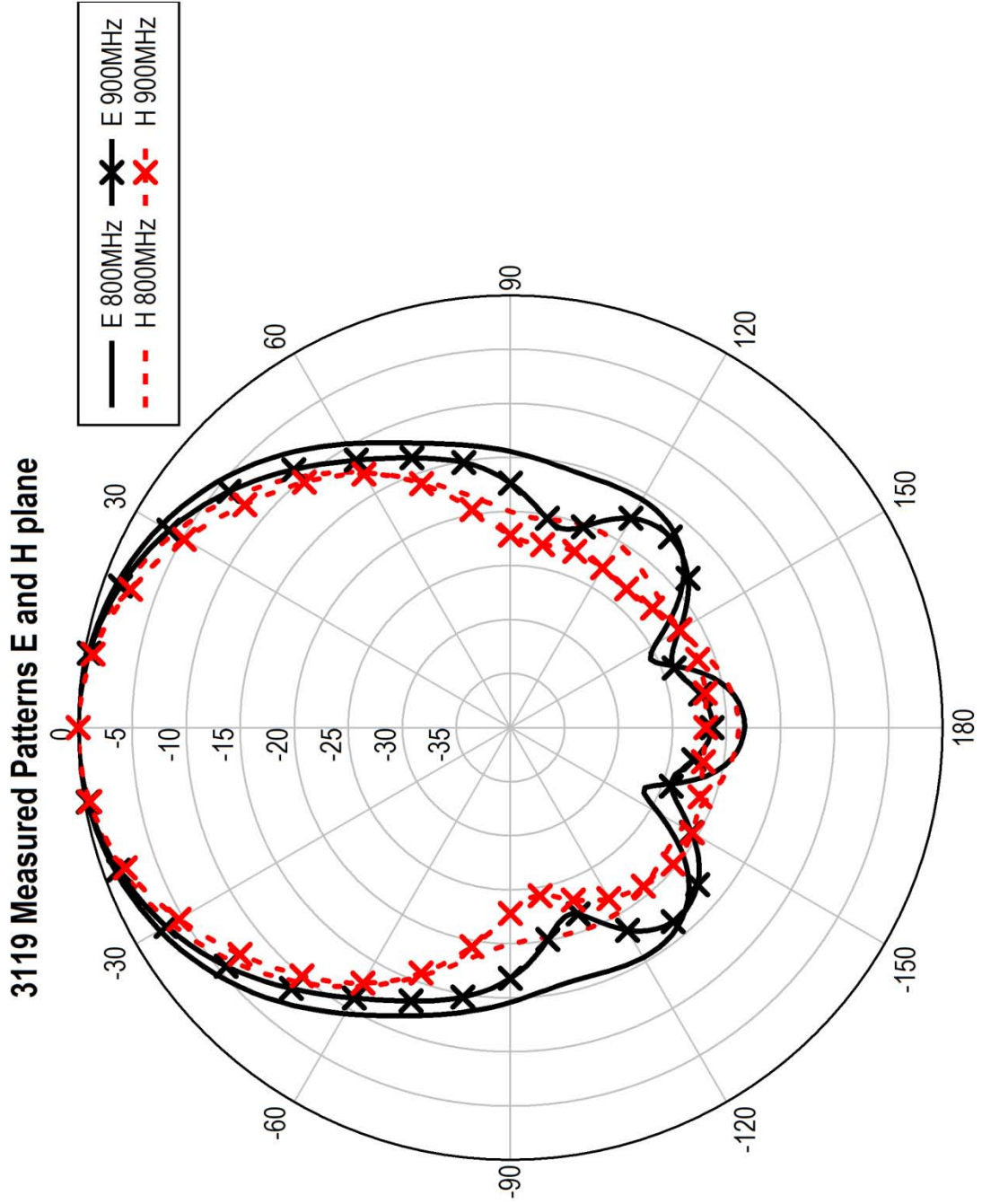

3119 Measured Patterns E and H plane

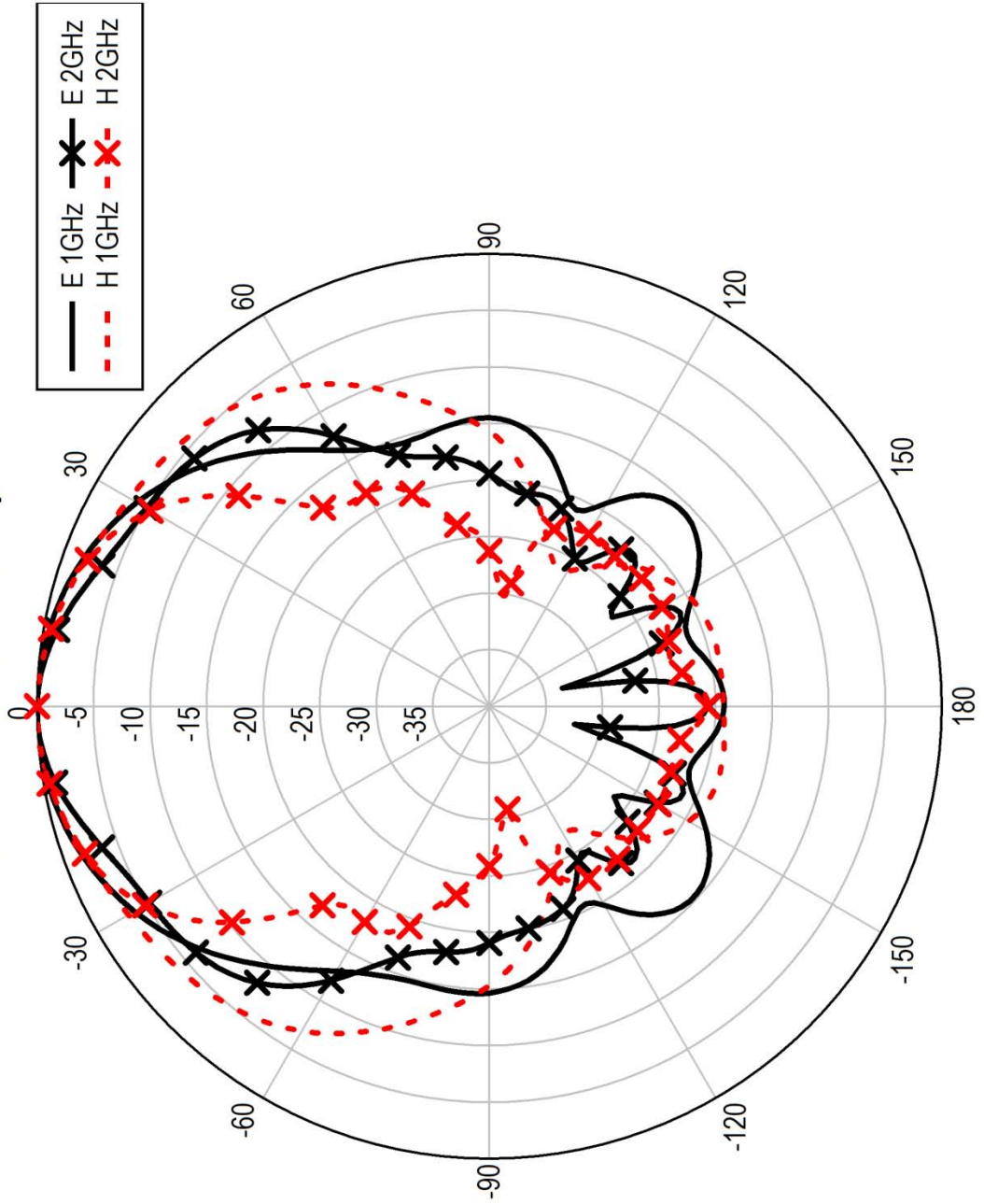

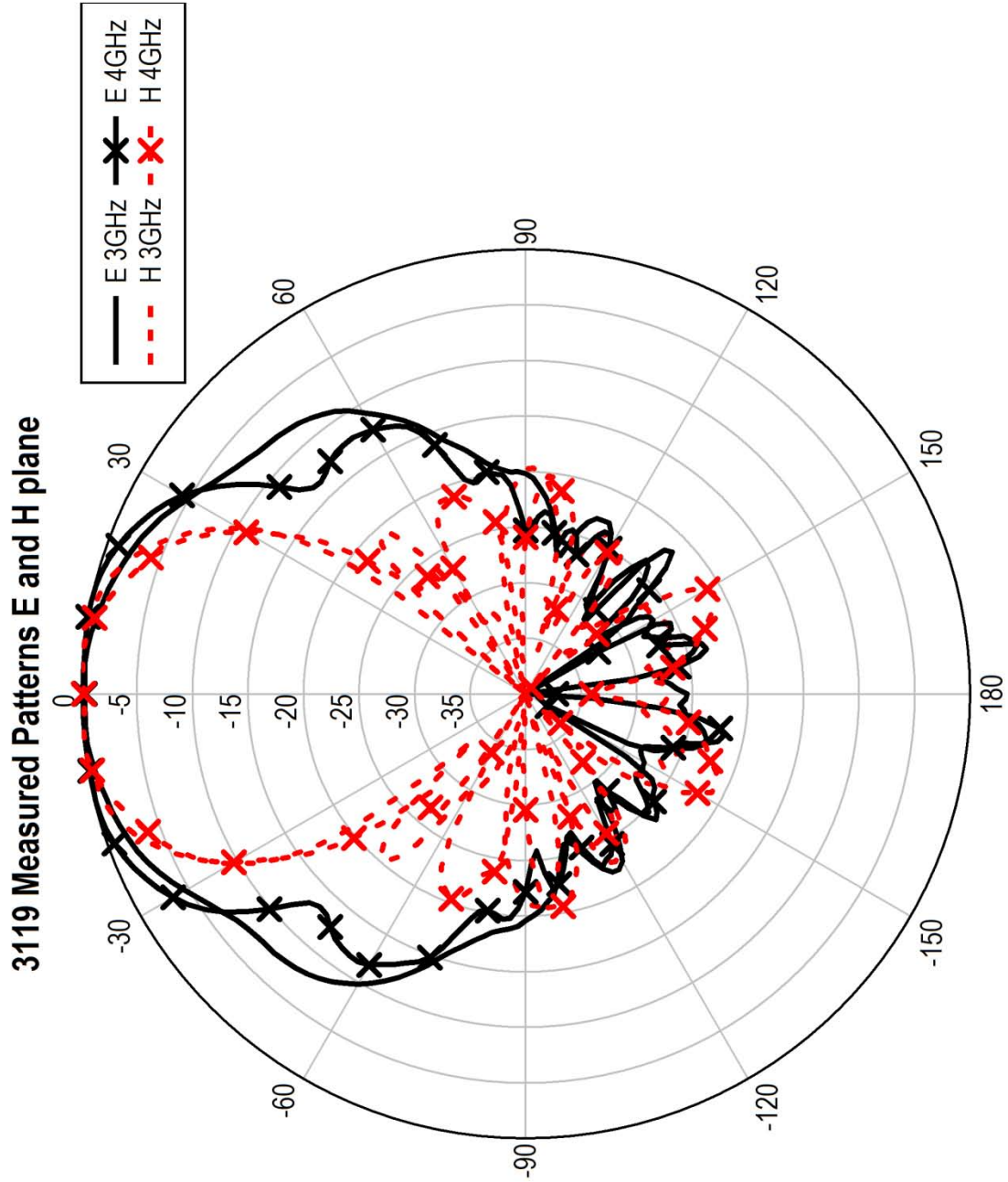

3119 Measured Patterns E and H plane

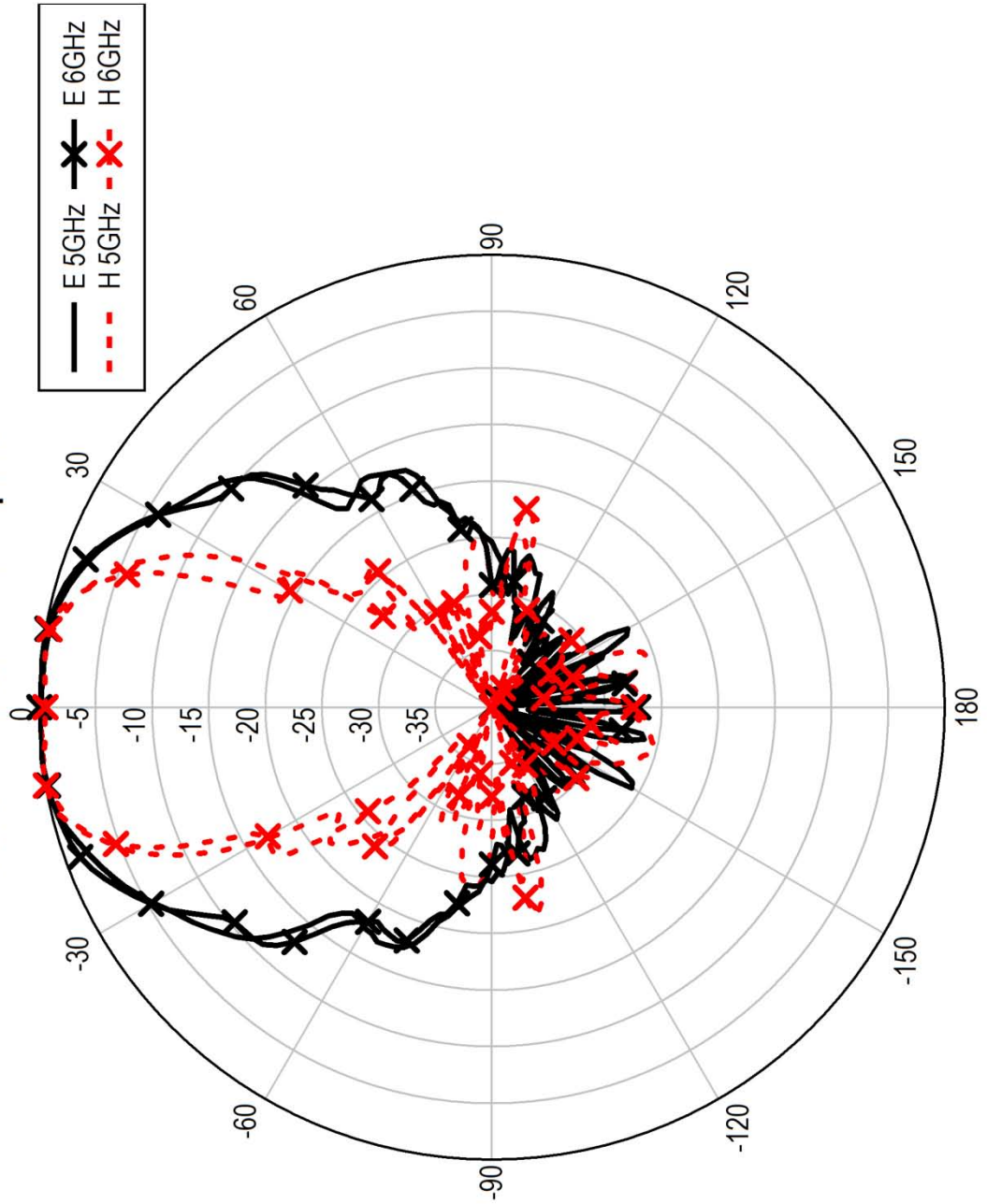

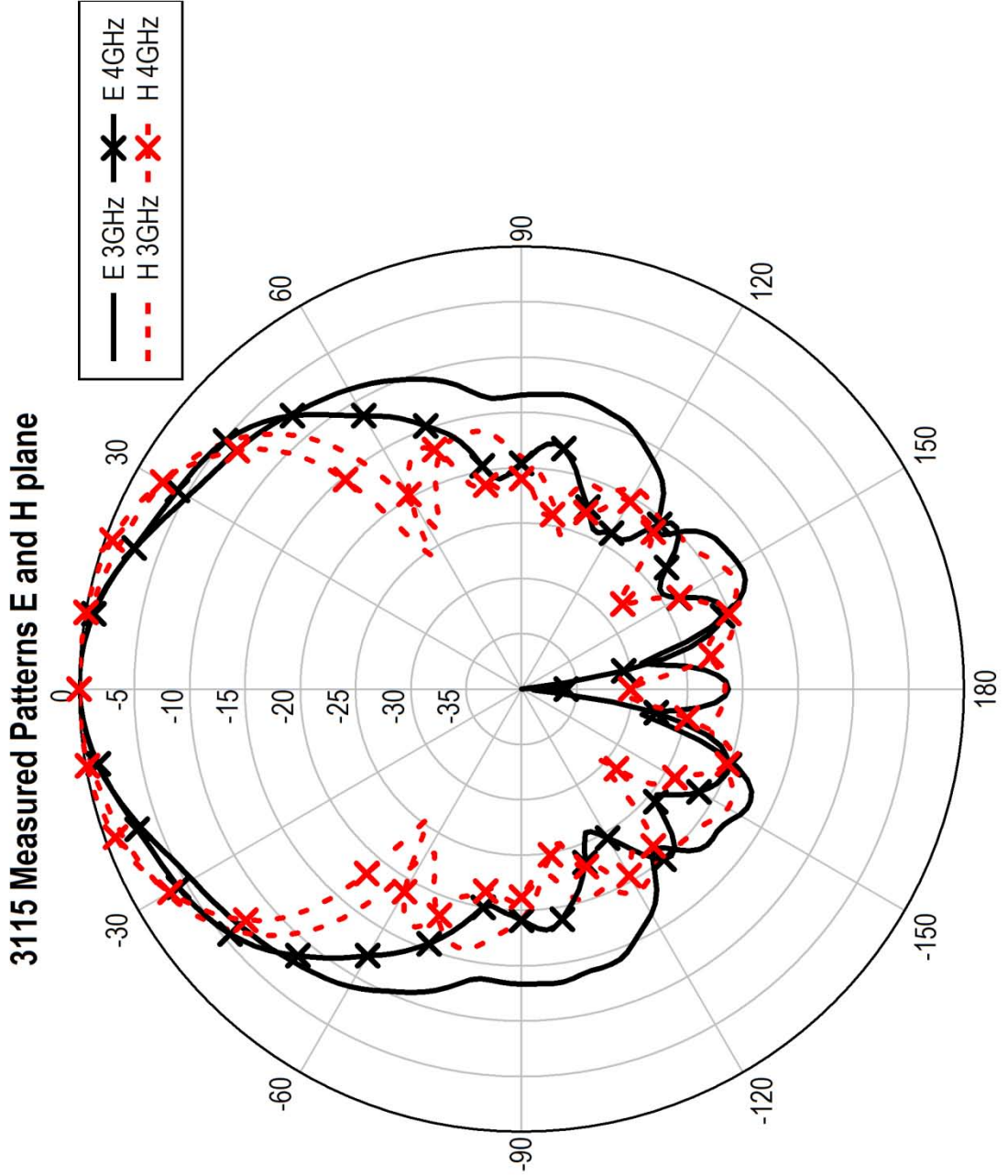

3115 Measured Patterns E and H plane

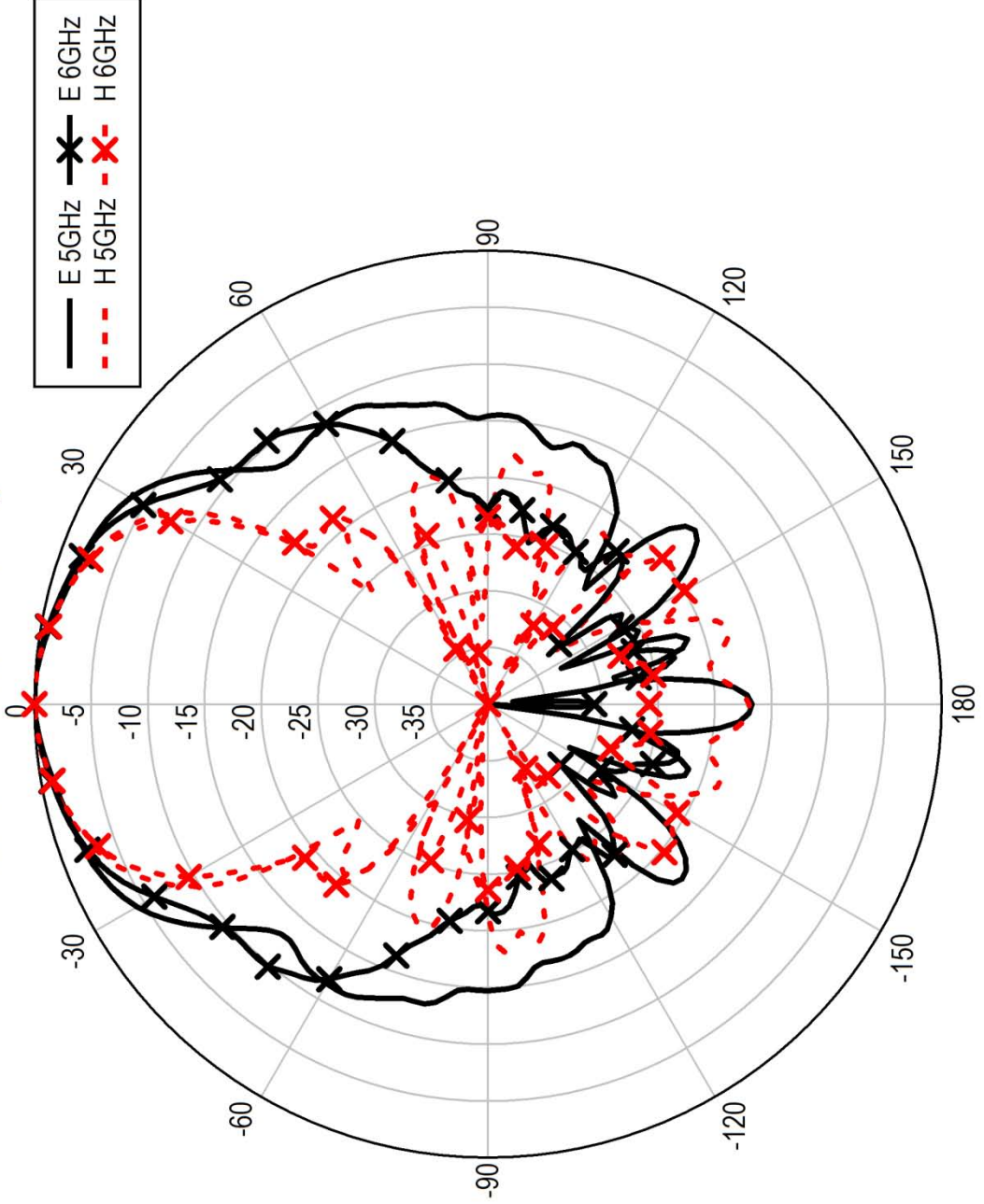

3115 Measured Patterns E and H plane

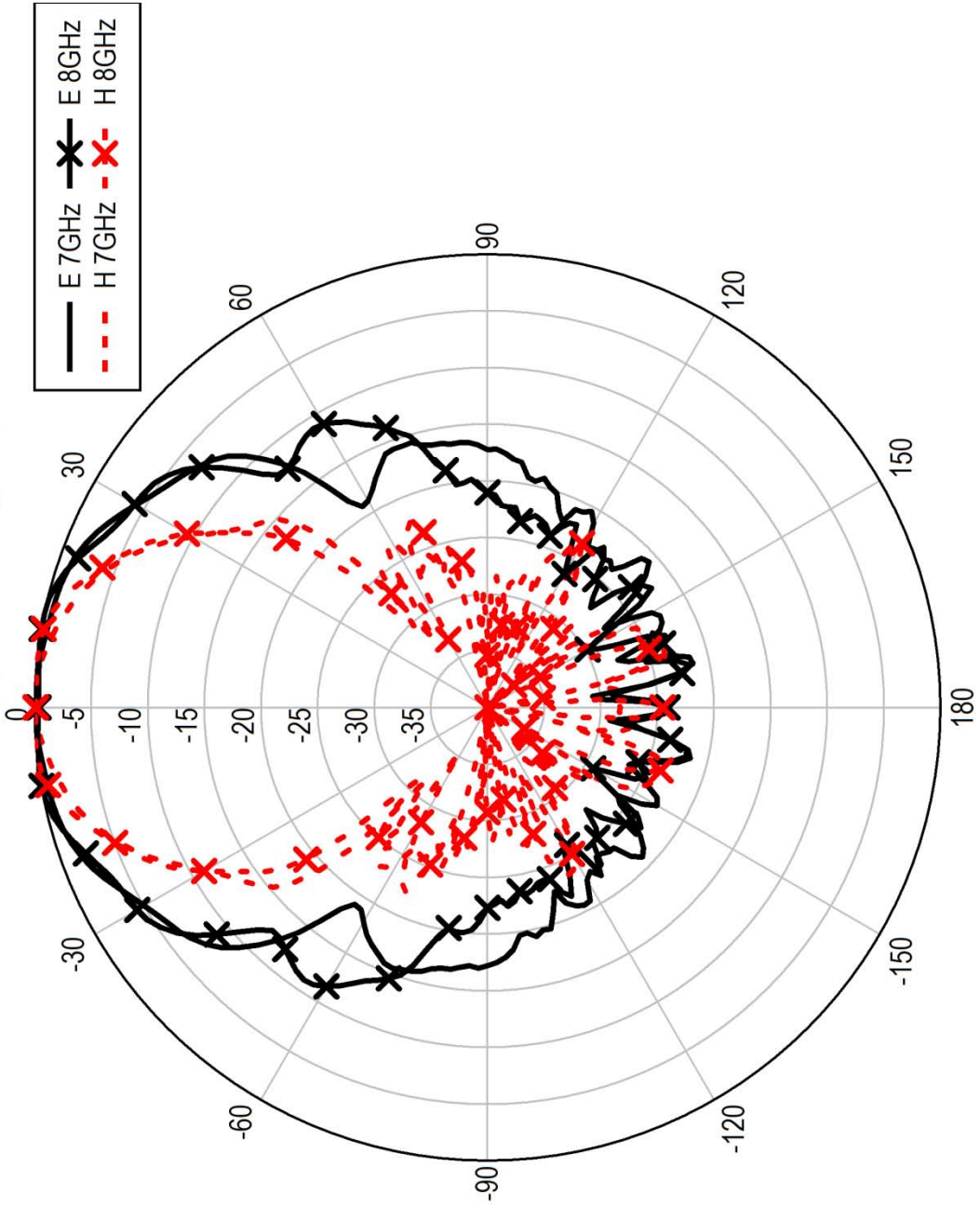

3115 Measured Patterns E and H plane

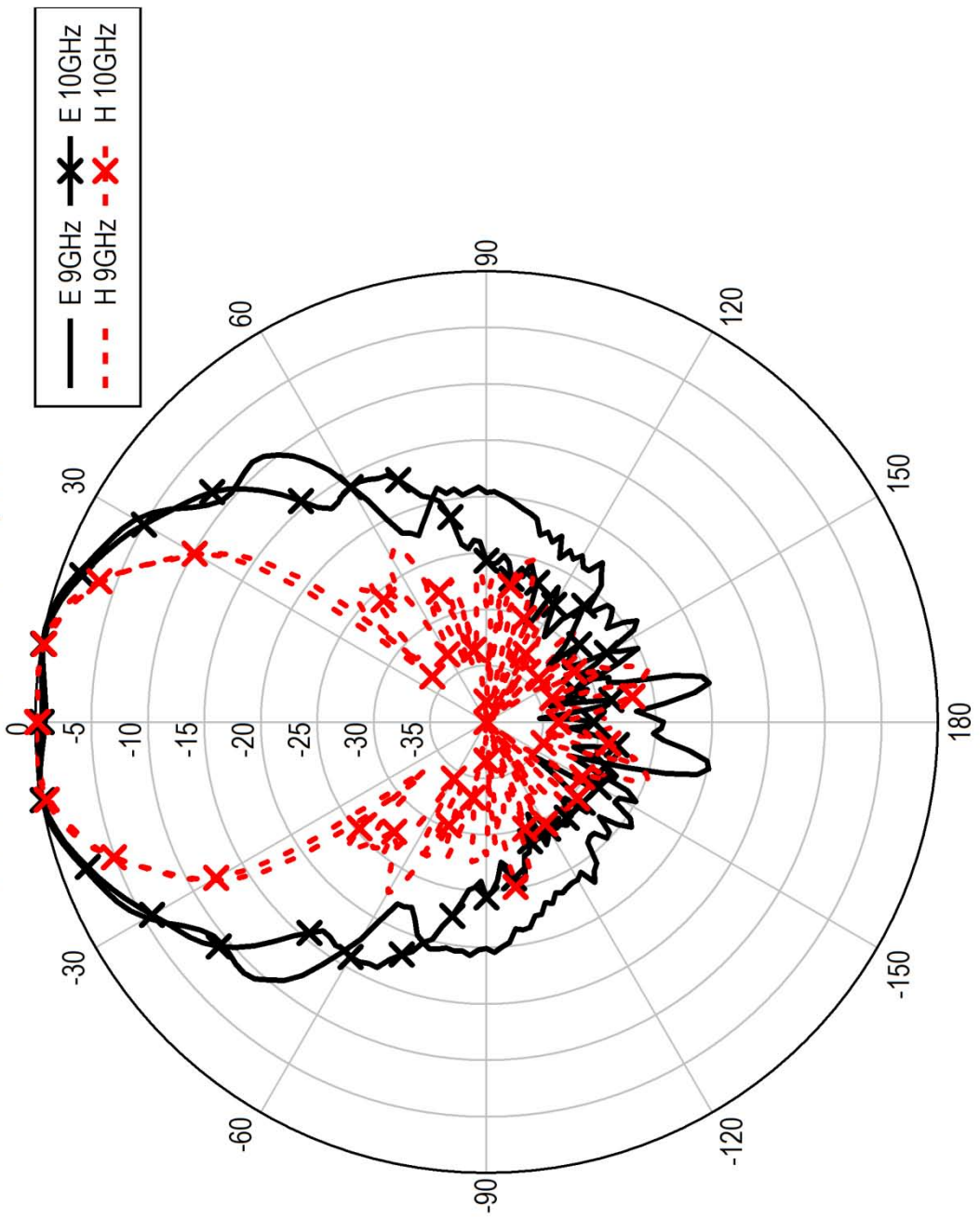

3115 Measured Patterns E and H plane

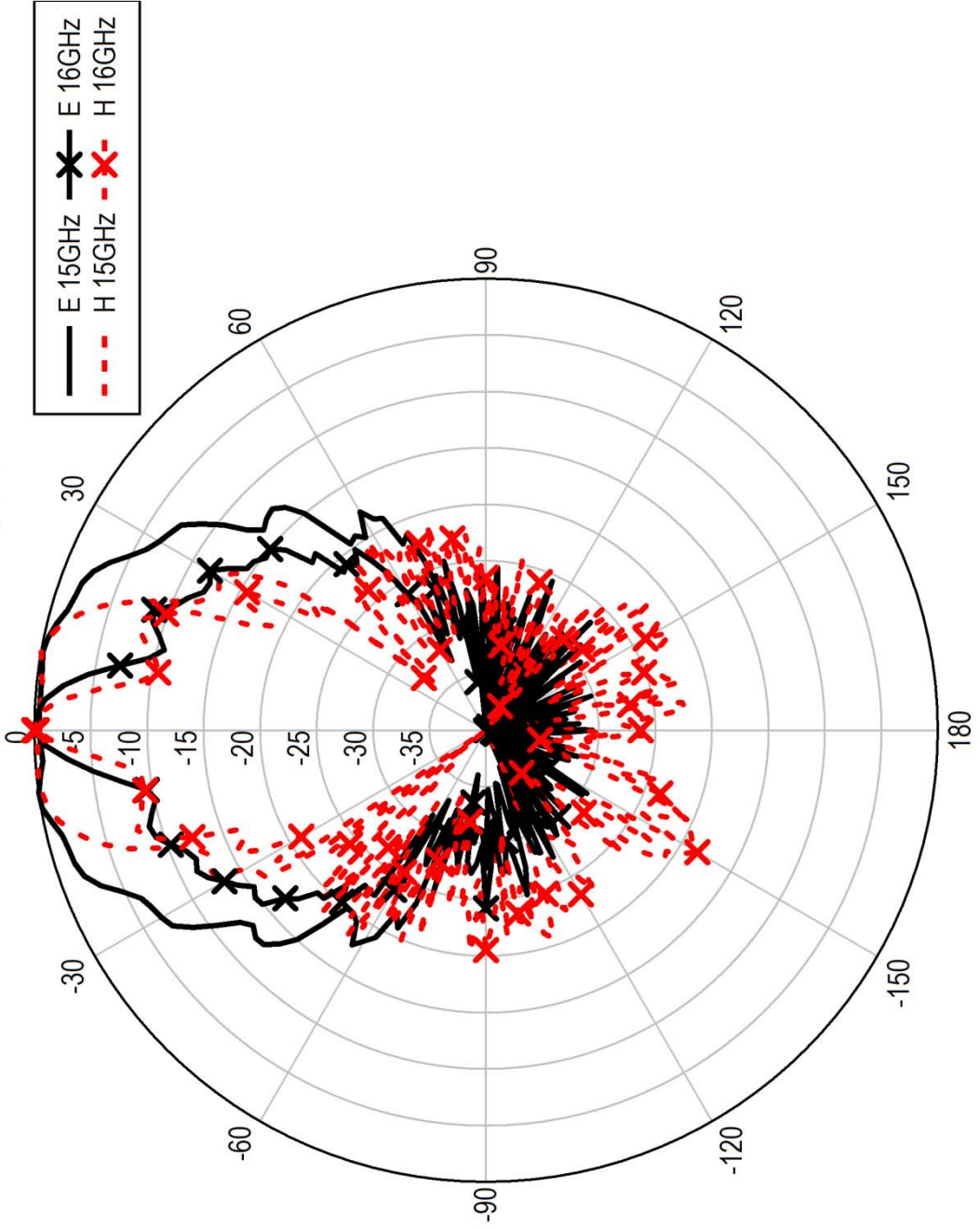

3115 Measured Patterns E and H plane

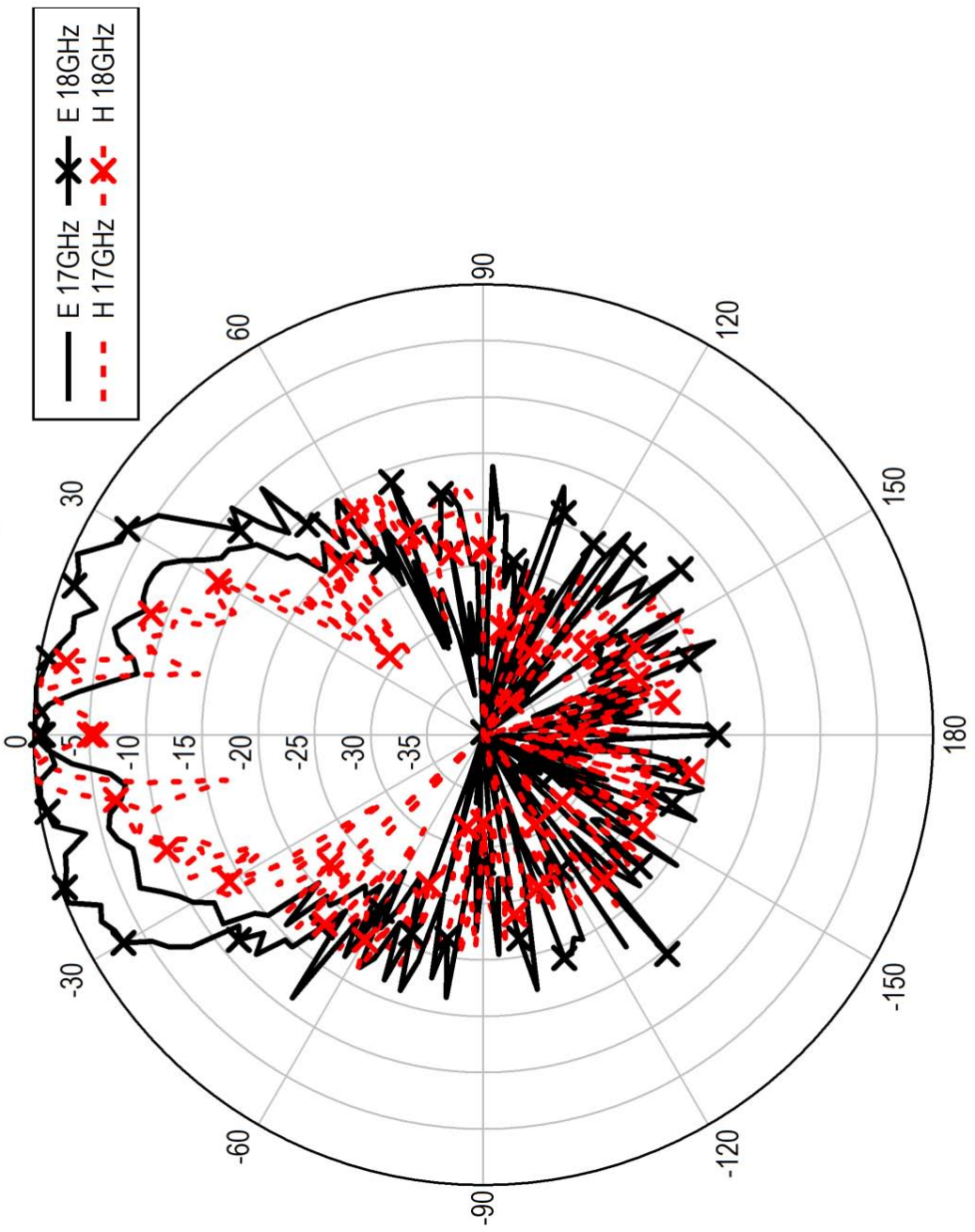

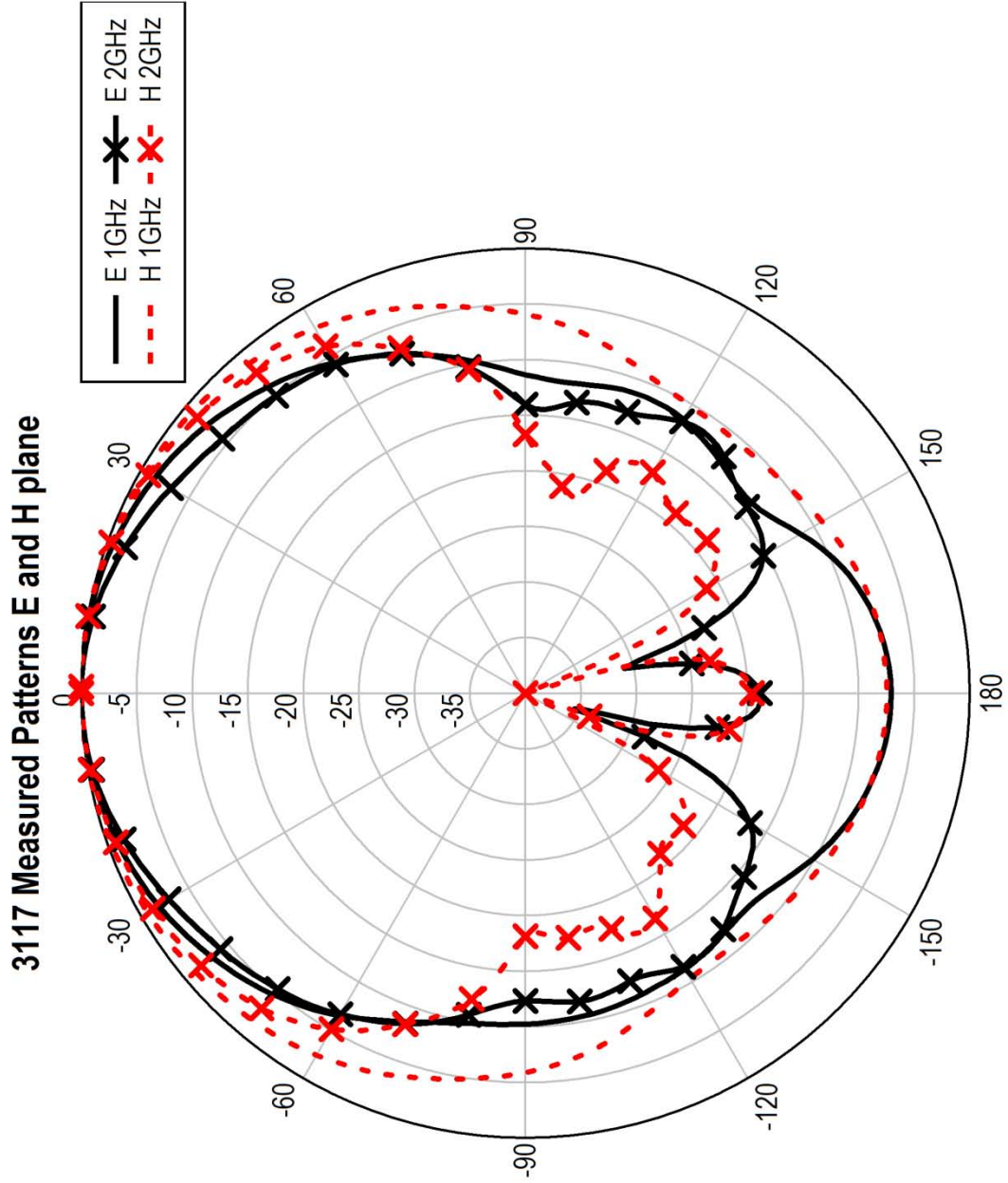

3117 Measured Patterns E and H plane

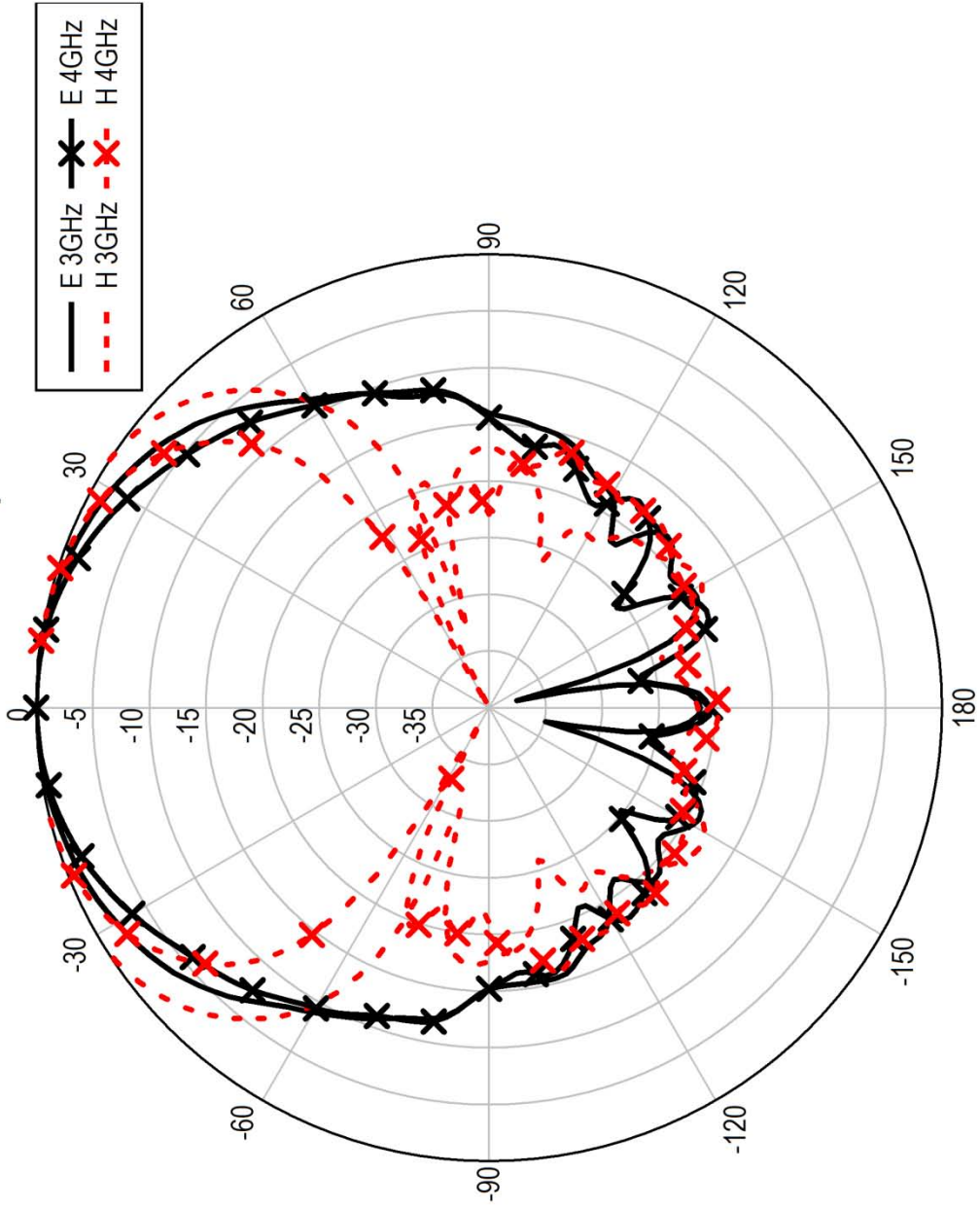

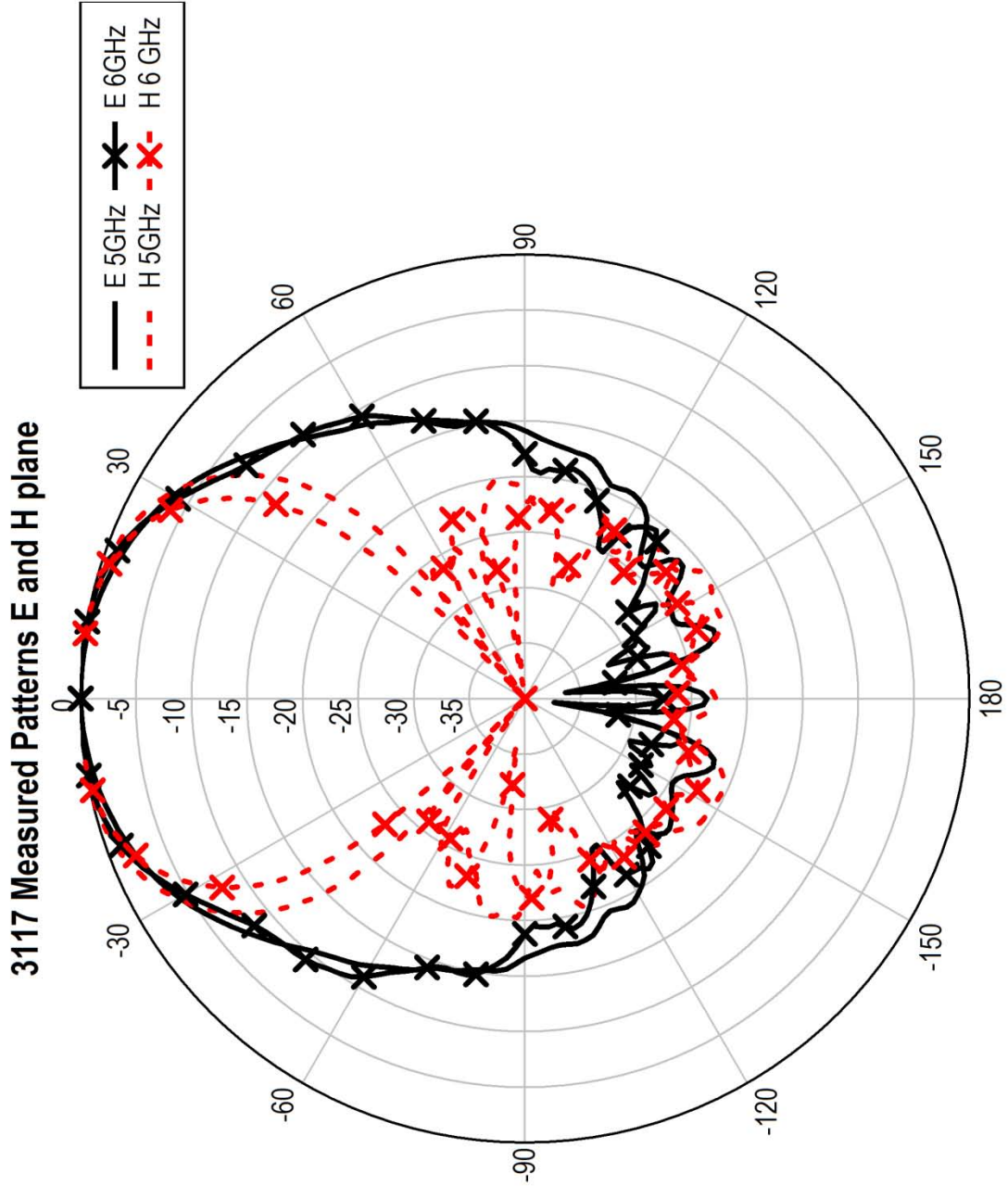

3117 Measured Patterns E and H plane

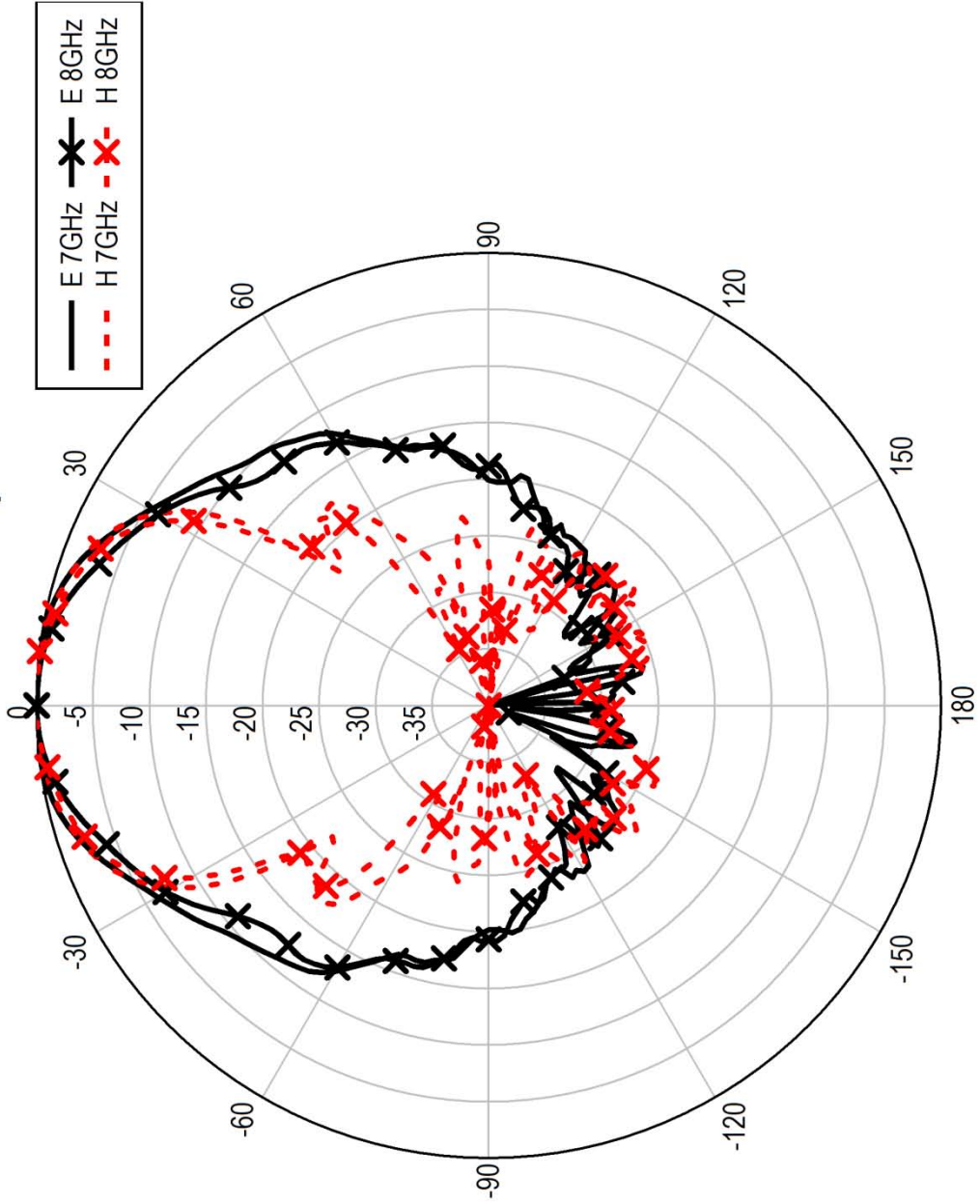

3117 Measured Patterns E and H plane

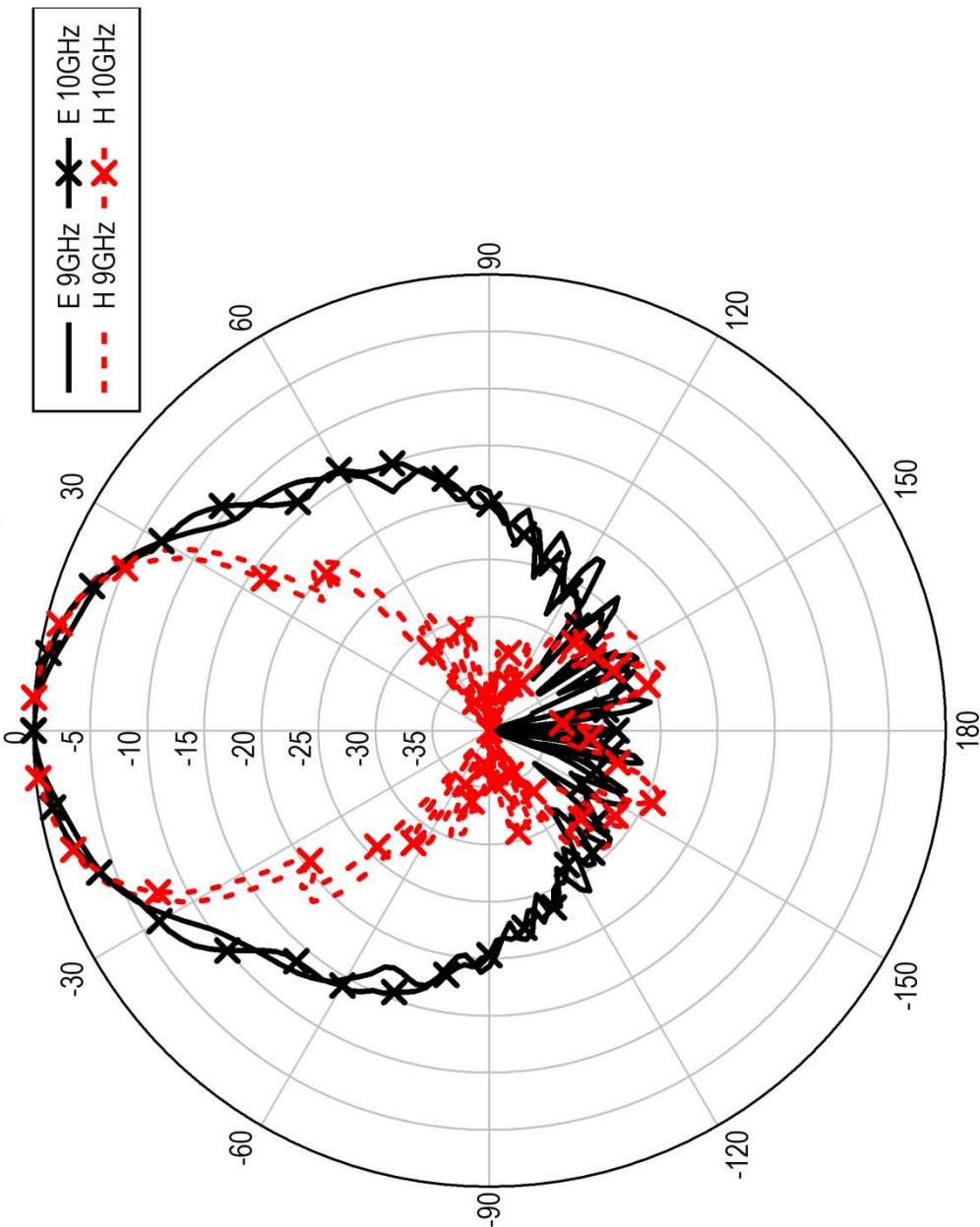

3117 Measured Patterns E and H plane

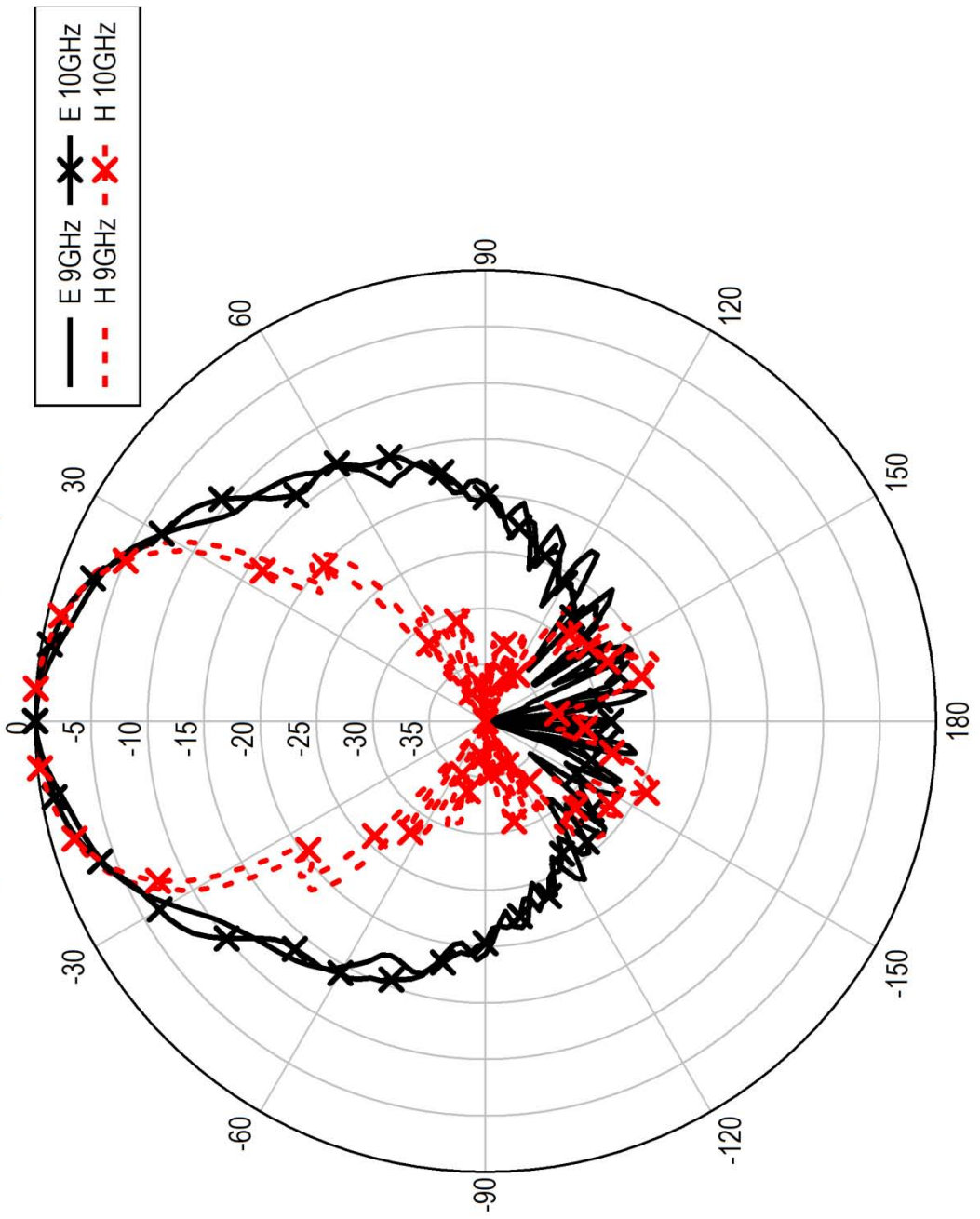

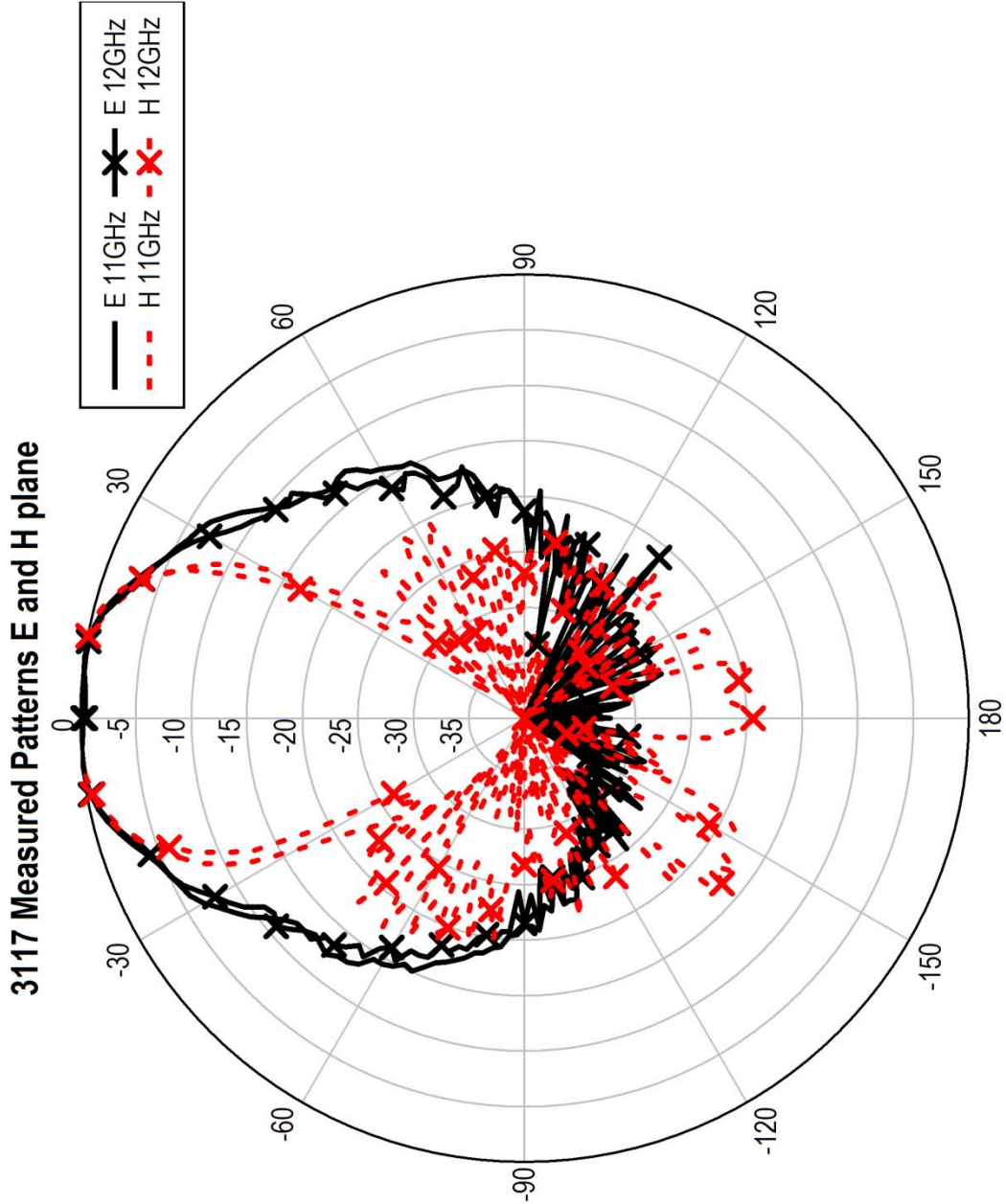

3117 Measured Patterns E and H plane

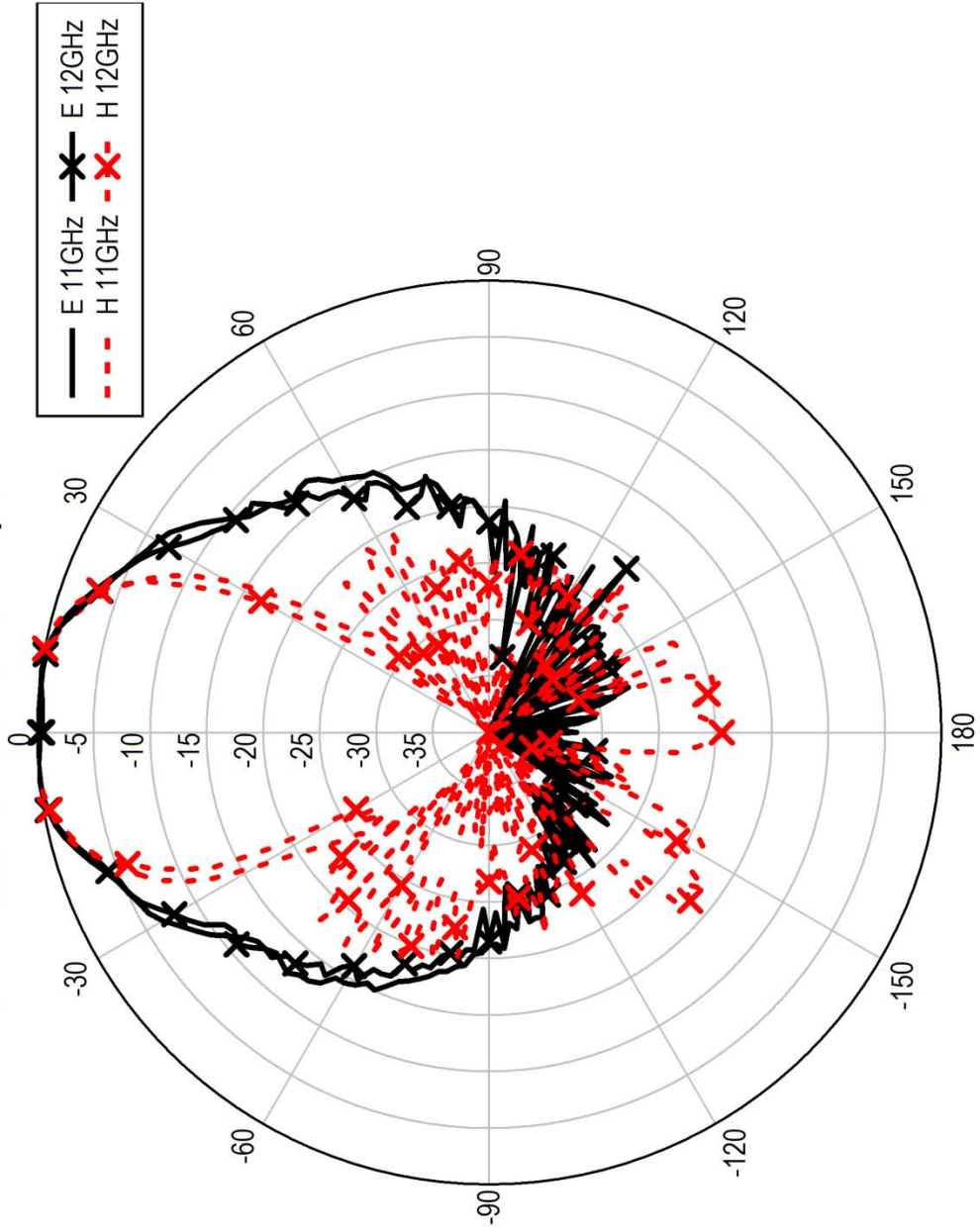

3117 Measured Patterns E and H plane

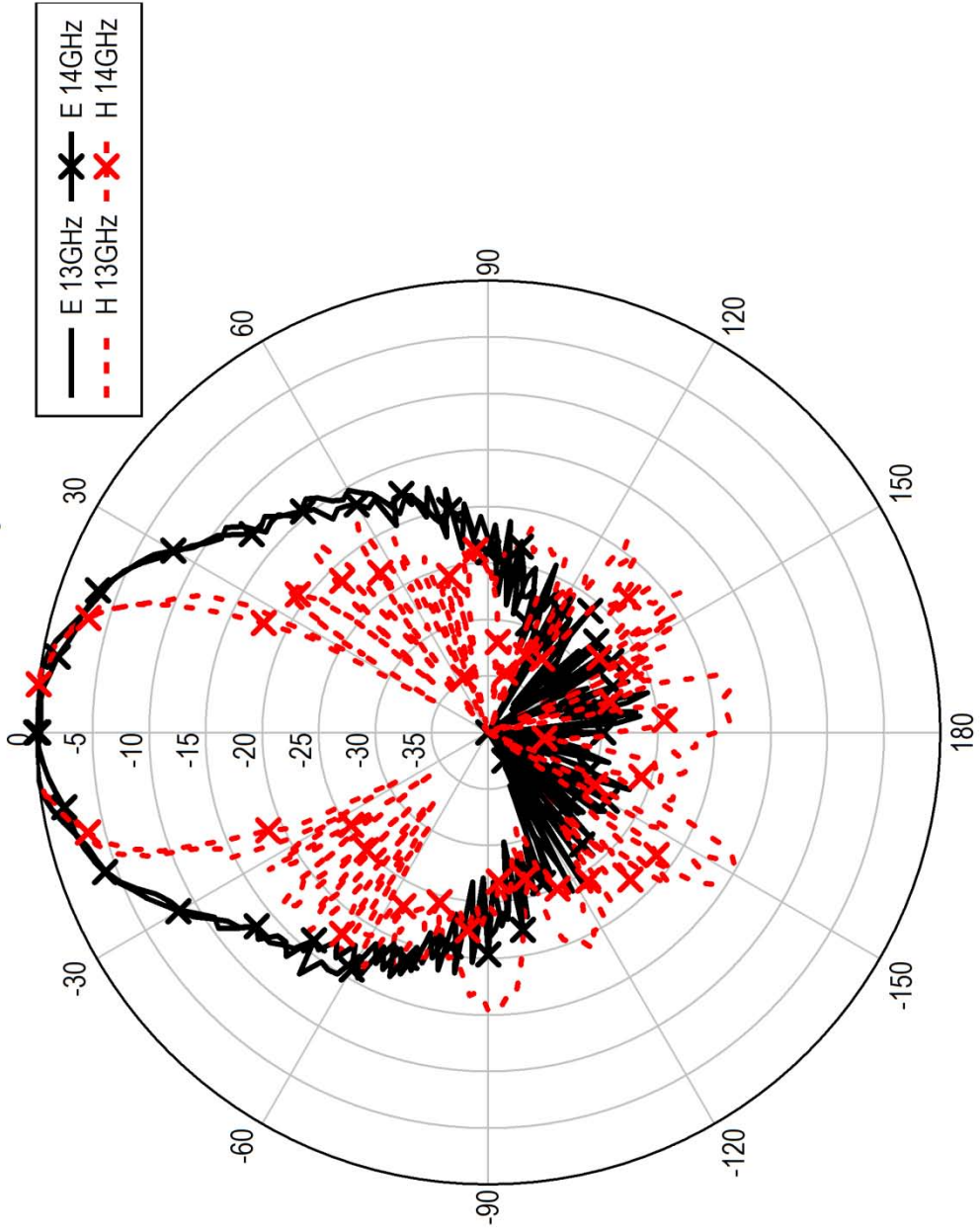

3117 Measured Patterns E and H plane

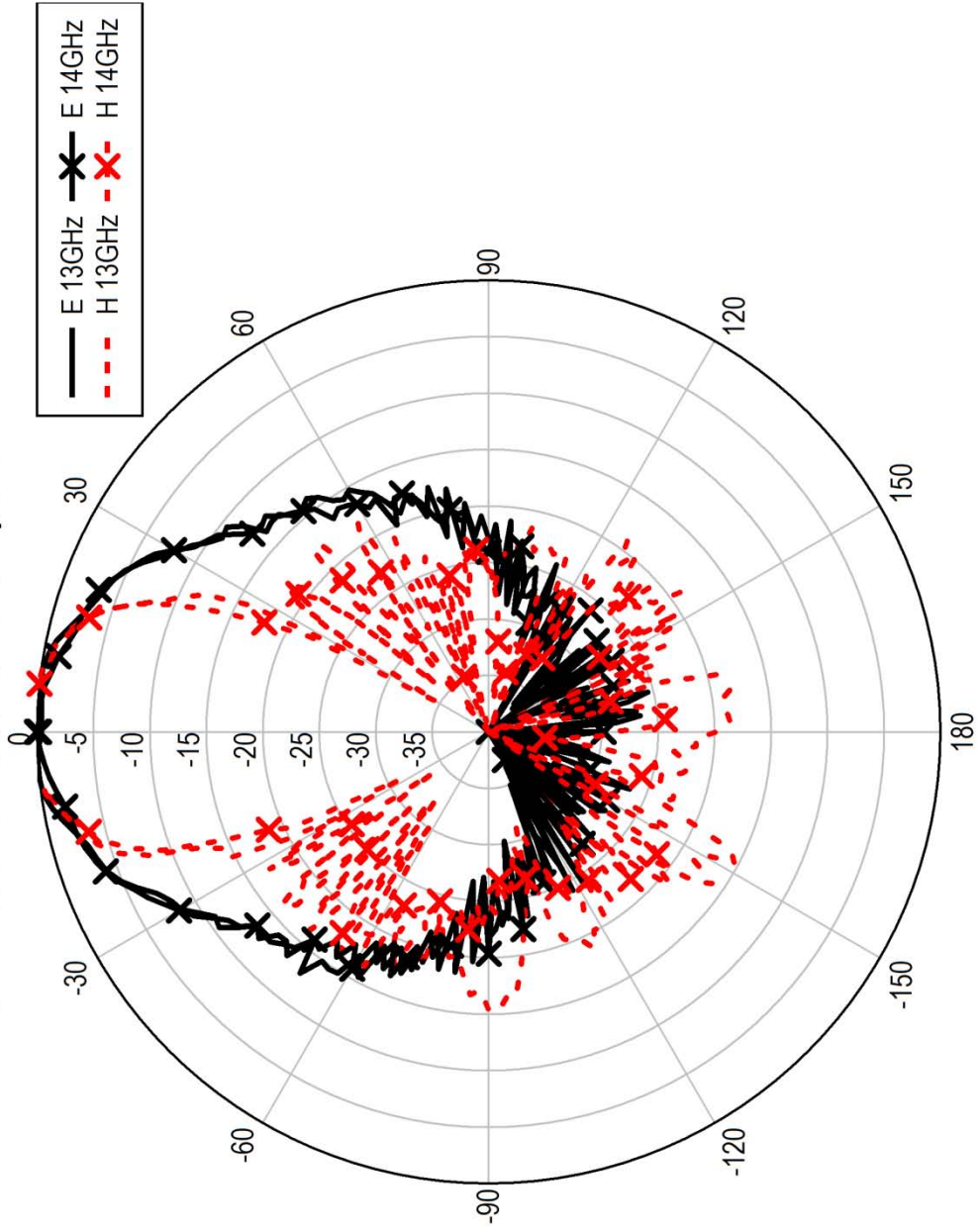

3117 Measured Patterns E and H plane

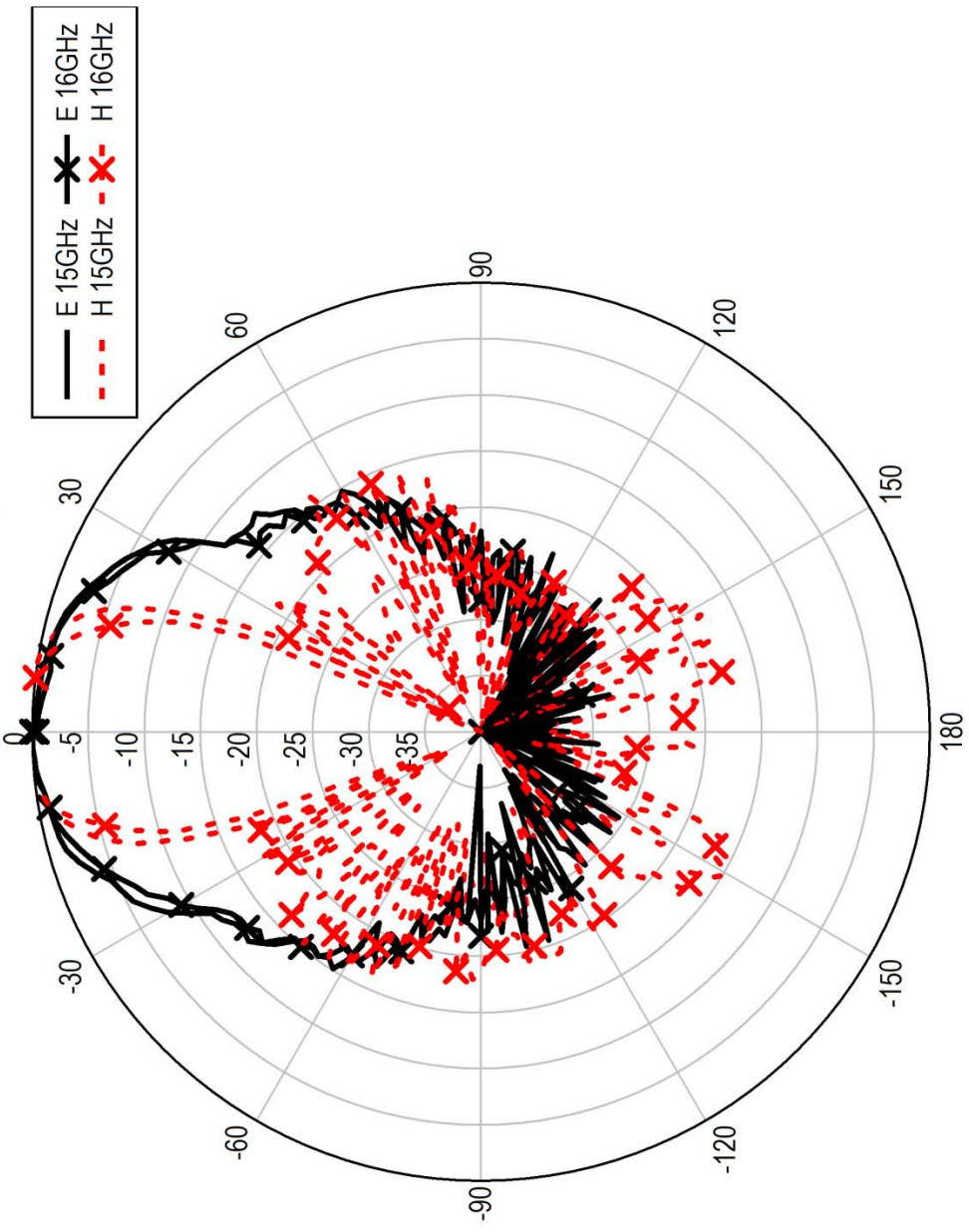

3117 Measured Patterns E and H plane

