

Model 3164 Series

Open Boundary Quad-Ridged Horns

User Manual



 **ETS-LINDGREN**[™]
An ESCO Technologies Company

ETS-Lindgren Inc. reserves the right to make changes to any product described herein in order to improve function, design, or for any other reason. Nothing contained herein shall constitute ETS-Lindgren Inc. assuming any liability whatsoever arising out of the application or use of any product or circuit described herein. ETS-Lindgren Inc. does not convey any license under its patent rights or the rights of others.

© Copyright 2007–2013 by ETS-Lindgren Inc. All Rights Reserved. No part of this document may be copied by any means without written permission from ETS-Lindgren Inc.

Trademarks used in this document: The *ETS-Lindgren* logo is a trademark of ETS-Lindgren Inc.; *WiMAX* is a trademark of the WiMAX Forum.

Revision Record
MANUAL,OBCH ANTENNA,3164 SERIES | Part #399288, Rev. E

Revision	Description	Date
A	Initial Release	March, 2007
B	Added 3164-08; updated 3164-05 mounting bracket; converted to half-size	February, 2008
C	Removed 3164-07; updated <i>Mounting Instructions</i> ; rebrand	June, 2010
D	Added 3164-10 content	November, 2010
E	Added 3164-11 content	September, 2013

Table of Contents

Notes, Cautions, and Warnings	vii
1.0 Introduction	9
Model 3164-05.....	10
Model 3164-06.....	11
Model 3164-08.....	11
Model 3164-10.....	12
Model 3164-11.....	12
Tripod Options	13
4-TR Tripod	13
7-TR Tripod	13
ETS-Lindgren Product Information Bulletin	14
2.0 Maintenance	15
Annual Calibration	15
Replacement and Optional Parts	16
Service Procedures	17
3.0 Specifications	19
Electrical Specifications	19
Model 3164-05.....	19
Model 3164-06.....	20
Model 3164-08.....	20
Model 3164-10.....	21
Model 3164-11.....	21
Physical Specifications	22
4.0 Application	23
5.0 Mounting Instructions	25
About Chamber Wall Mount.....	25
Mounting Features.....	25
Chamber Wall Mount Instructions	27
3164-05 / 3164-11 Chamber Wall Mount.....	27
3164-06 Chamber Wall Mount, Page 1	28
3164-06 Chamber Wall Mount, Page 2	29
3164-08 / 3164-10 Chamber Wall Mount, Page 1.....	30

3164-08 / 3164-10 Chamber Wall Mount, Page 2.....	31
Bracket Mount Instructions.....	32
3164-05 Bracket Mount.....	32
3164-06 / 3164-08 / 3164-10 Bracket Mount	33
3164-11 Bracket Mount.....	36
Additional Mounting Instructions for 3164-05	37
3164-05 Backplate Mount	37
3164-05 Center Rotation Mount	38
Summary of Mounting Options.....	39
4-TR Mounting (3164-05, 3164-11).....	39
7-TR, Mast Mounting (3164-06, 3164-08, 3164-10).....	40
2x2 Boom Mounting (3164-06, 3164-08, 3164-10).....	41
6.0 Model 3164-05 Typical Data	43
Model 3164-05 Gain Measured Per SAE 958 Method.....	43
Model 3164-05 VSWR – Both Ports.....	44
Model 3164-05 Cross-Port Isolation.....	45
Model 3164-05 Half-Power Beamwidth.....	46
Model 3164-05 10 dB Beamwidth	47
7.0 Model 3164-05 Typical Radiation Patterns	49
Model 3164-05 at 2 GHz.....	49
Model 3164 05 at 3 GHz.....	50
Model 3164-05 at 4 GHz.....	51
Model 3164-05 at 5 GHz.....	52
Model 3164-05 at 6 GHz.....	53
Model 3164-05 at 7 GHz.....	54
Model 3164-05 at 8 GHz.....	55
Model 3164-05 at 9 GHz.....	56
Model 3164-05 at 10 GHz.....	57
Model 3164-05 at 11 GHz.....	58
Model 3164-05 at 12 GHz.....	59
Model 3164-05 at 13 GHz.....	60
Model 3164-05 at 14 GHz.....	61
Model 3164-05 at 15 GHz.....	62
Model 3164-05 at 16 GHz.....	63
Model 3164-05 at 17 GHz.....	64

Model 3164-05 at 18 GHz	65
8.0 Model 3164-06 Typical Data	67
Model 3164-06 Gain	67
Model 3164-06 VSWR	68
Model 3164-06 3 dB Half-Power Beamwidth	69
Model 3164-06 Cross-Port Isolation	70
9.0 Model 3164-06 Typical Radiation Patterns	71
Model 3164-06 at 400 MHz–600 MHz	71
Model 3164-06 at 800 MHz–1000 MHz	72
Model 3164-06 at 2000 MHz–3000 MHz	73
Model 3164-06 at 4000 MHz–5000 MHz	74
Model 3164-06 at 6000 MHz	75
10.0 Model 3164-08 Typical Data	77
Model 3164-08 Gain	77
Model 3164-08 VSWR	78
Model 3164-08 Cross-Port Isolation	79
11.0 Model 3164-08 Typical Radiation Patterns	81
Model 3164-08 at 700 MHz–800 MHz	81
Model 3164-08 at 900 MHz–1000 MHz	82
Model 3164-08 at 1.5 GHz–2.0 GHz	83
Model 3164-08 at 2.5 GHz–3.0 GHz	84
Model 3164-08 at 3.5 GHz–4.0 GHz	85
Model 3164-08 at 4.5 GHz–5.0 GHz	86
Model 3164-08 at 5.5 GHz–6.0 GHz	87
Model 3164-08 at 6.5 GHz–7.0 GHz	88
Model 3164-08 at 7.5 GHz–8.0 GHz	89
Model 3164-08 at 8.5 GHz–9.0 GHz	90
Model 3164-08 at 9.5 GHz–10.0 GHz	91
12.0 Model 3164-10 Typical Data	93
Model 3164-10 Gain	93
Model 3164-10 VSWR	94
Model 3164-10 Cross-Port Isolation	95
13.0 Model 3164-10 Typical Radiation Patterns	97
Model 3164-10 E-Plane at 400 MHz–2000 MHz	97

Model 3164-10 H-Plane at 400 MHz–2000 MHz	98
Model 3164-10 E-Plane at 2000 MHz–10000 MHz	99
Model 3164-10 H-Plane at 2000 MHz–10000 MHz	100
14.0 Model 3164-11 Typical Data	101
Model 3164-11 Gain and Antenna Factor.....	101
Model 3164-11 VSWR	102
Model 3164-11 Cross-Port Isolation.....	103
Model 3164-11 Half-Power Beamwidth	104
15.0 Model 3164-11 Typical Radiation Patterns	105
Model 3164-11 at 1 GHz–2 GHz.....	105
Model 3164-11 at 3 GHz–4 GHz.....	106
Model 3164-11 at 5 GHz–6 GHz.....	107
Model 3164-11 at 7 GHz–8 GHz.....	108
Model 3164-11 at 9 GHz–10 GHz.....	109
Model 3164-11 at 11 GHz–12 GHz.....	110
Model 3164-11 at 13 GHz–14 GHz.....	111
Model 3164-11 at 15 GHz–16 GHz.....	112
Model 3164-11 at 17 GHz–18 GHz.....	113
Appendix A: Warranty	115

Notes, Cautions, and Warnings

	<p>Note: Denotes helpful information intended to provide tips for better use of the product.</p>
<p>CAUTION</p>	<p>Caution: Denotes a hazard. Failure to follow instructions could result in minor personal injury and/or property damage. Included text gives proper procedures.</p>
<p>WARNING</p>	<p>Warning: Denotes a hazard. Failure to follow instructions could result in SEVERE personal injury and/or property damage. Included text gives proper procedures.</p>



See the ETS-Lindgren *Product Information Bulletin* for safety, regulatory, and other product marking information.

This page intentionally left blank.

1.0 Introduction

The ETS-Lindgren Model 3164 Open Boundary Quad-Ridged Horns include the 3164-05, 3164-06, 3164-08, 3164-10, and 3164-11 antennas. The Model 3164 Series was designed for antenna pattern measurement ranging from the ultra-high frequency (UHF) to the Ku band. Each antenna is a dual linear polarized open boundary horn that allows the user to measure the principal polarizations of the field radiated by the antenna under test.



3164-05
Frequency range:
2 GHz to 18 GHz



3164-11
Frequency range:
1 GHz to 18 GHz



3164-08
Frequency range:
700 MHz to 10 GHz



3164-06
Frequency range:
300 MHz to 6 GHz



3164-10
Frequency range:
400 MHz to 10 GHz

The Model 3164 Series antennas are precision machined from aluminum and PVC. Two orthogonally-placed input connectors permit simultaneous measurements for horizontal and vertical polarizations for linearly polarized electromagnetic waves. By using an additional 90-degree hybrid phase shifter, the antennas may be used to transmit or receive circularly polarized electromagnetic waves.

Testing of the Model 3164 Series shows that the isolation level between the two orthogonal test ports is better than 24 dB in the specified operating frequency range. The port isolation is the limiting factor in the cross-polarization levels of the antenna.

The Model 3164 Series antennas are designed to operate from 300 MHz to 18 GHz in a free-space environment. When the antenna is installed in a rectangular shielded anechoic chamber, the equipment under test must be at a test distance meeting the far field requirements to operate either antenna within the full frequency range.

In a quasi-free space test environment such as a tapered anechoic chamber, the Model 3164 Series antennas are ideal plane-wave transmit and receive antennas. They are ideal for use in a taper chamber over the entire range, provided it is repositioned inside the taper to obtain the optimum illumination.

The Model 3164 Series antennas ship with standard mounting hardware. For the variety of mounting options available for each antenna, see *Mounting Instructions* on page 25.

Model 3164-05

The 3164-05 is the smallest of the Model 3164 Series, with an operating range of 2 GHz to 18 GHz.

The 3164-05 is designed for the antenna measurement in the MW range, and covers the S, C, X, and Ku bands. It was designed as a receive antenna, but can be used as a low power radiator with a maximum continuous power handling capability of 10 W.



Model 3164-06

The 3164-06 is the largest of the Model 3164 Series, with an operating range of 300 MHz to 6 GHz.

The 3164-06 is designed as a receive antenna, but can also be used to transmit with a power handling capability of 20 W. The 3164-06 is ideal for taper chambers.



Model 3164-08

The 3164-08 is the larger of the medium-sized antennas of the Model 3164 Series, with an operating range of 700 MHz to 10 GHz.

With the highest gain in the 5.8 GHz range, the 3164-08 is ideal for WiMAX™ testing. Additional applications include UWB wireless testing (3 GHz to 10 GHz) and lower frequency testing (700 MHz to 3 GHz) for applications such as GSM, PCS, and WiFi.



Model 3164-10

With a frequency range of 400 MHz to 10 GHz, the 3164-10 covers all wireless frequency bands, including cell phone, Wi-Fi, WiMAX, and GPS bands.

Additional applications include UWB wireless testing (3 GHz to 10 GHz) and lower frequency testing (400 MHz to 3 GHz) for GSM, PCS, Wi-Fi, and WiMAX applications.

Designed to measure wireless devices over-the-air (OTA), the 3164-10 also has excellent gain characteristics and low VSWR.



Model 3164-11

With a frequency range of 1 GHz to 18 GHz, the 3164-11 can be used to measure other antennas, like the 3164-05. Its frequency range makes it ideal as an EMC antenna for measuring emissions above 1 GHz per the CISPR 16 standard or the ANSI C63.4 standard.

The 3164-11 includes a bracket for mounting to a 4-TR tripod or 7-TR tripod. For mounting information, see *Mounting Instructions* on page 23.



Tripod Options

CAUTION

Due to the size and weight of these models, never mount the 3164-06, 3164-08, or 3164-10 onto a 4-TR Tripod.

4-TR TRIPOD

Constructed of linen phenolic and delrin, designed with an adjustable center post for precise height adjustments. Maximum height is 2.0 m (80.0 in), and minimum height is 94 cm (37.0 in). This tripod can support up to an 11.8 kg (26.0 lb) load.



7-TR TRIPOD

Constructed of PVC and fiberglass components, providing increased stability for physically large antennas. The unique design allows for quick assembly, disassembly, and convenient storage. Allows several different configurations, including options for manual or pneumatic polarization. Quick height adjustment and locking wheels provide ease of use during testing. Maximum height is 2.17 m (85.8 in), with a minimum height of 0.8 m (31.8 in). This tripod can support a 13.5 kg (30 lb) load.



ETS-Lindgren Product Information Bulletin

See the ETS-Lindgren *Product Information Bulletin* included with your shipment for the following:

- Warranty information
- Safety, regulatory, and other product marking information
- Steps to receive your shipment
- Steps to return a component for service
- ETS-Lindgren calibration service
- ETS-Lindgren contact information

2.0 Maintenance

CAUTION

Before performing any maintenance, follow the safety information in the ETS-Lindgren *Product Information Bulletin* included with your shipment.



Maintenance of the Model 3164 Series is limited to external components such as cables or connectors.

If you have any questions concerning maintenance, contact ETS-Lindgren Customer Service.

Annual Calibration

See the *Product Information Bulletin* included with your shipment for information on ETS-Lindgren calibration services.

Replacement and Optional Parts



ETS-Lindgren may substitute a similar part or new part number with the same functionality for another part/part number. Contact ETS-Lindgren for questions about part numbers and ordering parts.

Following are the part numbers for ordering replacement or optional parts for the Model 3164 Open Boundary Quad-Ridged Horns.

	Part Description	Part Number
3164-05	4-TR Tripod	4-TR
	7-TR Tripod	7-TR
	Bracket mount	108071
	Knob for bracket mount, 1/4–20 thread	H-34JCL-34
	Offset boom assembly for stinger mounts	108983
	Stinger for center rotation mount	108070
	1/4–20 set screw for Stinger	910467
	SMA connector (2)	512082
3164-06	7-TR Tripod	7-TR
	Bracket mount	106974
	Knob for boom mount	104136
	SMA connector (2)	512082
3164-08	7-TR Tripod	7-TR
	Bracket mount	106974
	Threaded insert for tripod mount	105861
	Knob for boom mount	104136
	SMA connector (2)	512082

	Part Description	Part Number
3164-10	7-TR Tripod	7-TR
	Bracket mount	106974
	Threaded insert for tripod mount	105861
	Knob for boom mount	104136
	SMA connector (2)	512082

3164-11	4-TR Tripod	4-TR
	7-TR Tripod	7-TR
	Bracket mount with knob	119430
	Threaded insert for tripod mount	105861
	Knob for boom mount	104136
	SMA connector (2)	512082

Service Procedures

For the steps to return a system or system component to ETS-Lindgren for service, see the *Product Information Bulletin* included with your shipment.

This page intentionally left blank.

3.0 Specifications

Electrical Specifications

MODEL 3164-05

Frequency Range:	2 GHz–18 GHz
Max VSWR:	< 3.25:1
Gain over Operating Frequency:	See Gain data on page 43
Maximum Continuous Power:	10 W
Impedance (Nominal):	50 Ω
Connector:	SMA (2) female
Cross Polarization Isolation:	> 24 dB
Dual Polarization Symmetry:	See Gain data on page 43

MODEL 3164-06

Frequency Range:	300 MHz–6 GHz
Max VSWR:	< 6.5:1
Gain over Operating Frequency:	See Gain data on page 67
Maximum Continuous Power:	150 W at 300 MHz 25 W at 6 GHz
Impedance (Nominal):	50 Ω
Connector:	SMA (2) female
Cross Polarization Isolation:	> 25 dB
Dual Polarization Symmetry:	See Gain data on page 67

MODEL 3164-08

Frequency Range:	700 MHz–10 GHz
Max VSWR:	< 3:1
Gain over Operating Frequency:	See Gain data on page 77
Maximum Continuous Power:	100 W at 700 MHz 20 W at 10 GHz
Impedance (Nominal):	50 Ω
Connector:	SMA (2) female
Cross Polarization Isolation:	> 20 dB
Dual Polarization Symmetry:	See Gain data on page 77

MODEL 3164-10

Frequency Range:	400 MHz–10 GHz
Max VSWR:	< 5:1 (Avg 1.75:1)
Gain over Operating Frequency:	See Gain data on page 93
Maximum Continuous Power:	100 W at 400 MHz 20 W at 10 GHz
Impedance (Nominal):	50 Ω
Connector:	SMA (2) female
Cross Polarization Isolation:	–25 dB
Dual Polarization Symmetry:	See Gain data on page 93

MODEL 3164-11

Frequency Range:	1 GHz–18 GHz
Max VSWR:	3.2:1
Gain over Operating Frequency:	See Gain data on page 101
Maximum Continuous Power:	100 W
Impedance (Nominal):	50 Ω
Connector:	SMA (2) female
Cross Polarization Isolation:	>25 dB
Dual Polarization Symmetry:	See Gain data on page 101

Physical Specifications

	Model 3164-05	Model 3164-06	Model 3164-08	Model 3164-10	Model 3164-11
Height:	17.1 cm 6.7 in	50.80 cm 20 in	36.07 cm 14.2 in	36.07 cm 14.2 in	17.6 cm 6.9 in
Width:	17.1 cm 6.7 in	50.80 cm 20 in	36.07 cm 14.2 in	36.07 cm 14.2 in	17.6 cm 6.9 in
Depth:	18.6 cm 7.3 in	50.80 cm 20 in	36.58 cm 14.4 in	36.58 cm 14.4 in	19 cm 7.5 in (with mount bracket add 8.6 cm/3.4 in)
Weight:	0.7 kg 1.5 lb	9.5 kg 21 lb	5.1 kg 11.4 lb	3.4 kg 7.4 lb	1kg 2.2 lb

4.0 Application

The Model 3164 Open Boundary Quad-Ridged Horns can be used as transmit or receive antennas for measuring all wireless telecommunications devices, such as cell phones and Internet devices. Additionally, the antennas cover most of the common radar and MW bands used in military applications.

When an antenna is configured for receive mode, it can be used to measure far field antenna patterns for the two orthogonal polarizations simultaneously. When an antenna is configured for transmit mode, it can be used to transmit signals from a base station simulator. Many intrinsic RF properties of wireless handsets can be measured at these two configurations. The user may also configure the same system to measure the RF interaction between a wireless handset and the operator.

The Model 3164 Series can also be configured to transmit or receive circularly polarized signals for testing antennas or receiving devices for Global Positioning Systems.

This page intentionally left blank.

5.0 Mounting Instructions

CAUTION

The Model 3164 Series antennas are precision measurement devices. Handle your antenna with care.

About Chamber Wall Mount

The Model 3164 Series Open Boundary Quad-Ridged Horns can be mounted directly on the shield line of a shielded anechoic chamber.



When mounted, the SMA connectors on the 3164-10 and 3164-11 will be located inside the chamber and must be routed by cables to outside the chamber during installation.

MOUNTING FEATURES

- **Chamber wall mounting holes—**
Equidistant holes around the circumference of the adapter plate accept 1/4–20 thread screws and nuts for mounting to a chamber wall.

Chamber wall mounting holes
around circumference of adapter plate

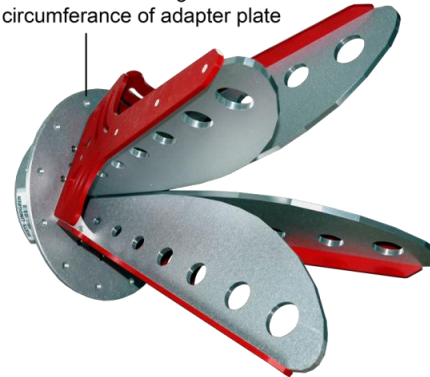

Model 3164-08 shown

- **Easy access to SMA connectors**—The circular mounting plate provides the primary interface to the shielded enclosure mount panel. By fastening the mounting plate to the shielded enclosure, the two SMA connectors are on the outside of the enclosure (3164-05, 3164-06, and 3164-08 only), providing easy access. This also puts the cables outside of the enclosure, which reduces the effect of the cables on the measurement.
- **Security of shielding integrity**—The back end of the antenna is machined of a single aluminum block, so the shielding effectiveness of the enclosure is not compromised by installation. This unique feature eliminates the need for a transmit antenna positioning device or a walk path inside the shielded anechoic chamber, both of which could present unwanted reflections of shielded anechoic chambers when installed improperly.
- **Maximize test range distance**—The integrated mount fixture allows maximizing of the test range distance for a shielded anechoic chamber of defined dimensions.

Chamber Wall Mount Instructions

3164-05 / 3164-11 CHAMBER WALL MOUNT



The radius and hole pattern of the adapter plate for the 3164-05 and 3164-11 are identical. However, when mounted to the chamber wall:

- The SMA connectors on the 3164-05 will remain outside the chamber wall.
- The SMA connectors on the 3164-11 will remain inside the chamber wall.

The 3164-05 and 3164-11 each provide eight equidistant holes around the circumference of the adapter plate of the antenna. These holes accept 1/4–20 thread screws and nuts for mounting to a chamber wall.

Ø 0.265 holes (8),
equally spaced in adapter plate
for 1/4-20 mounting screws and nuts

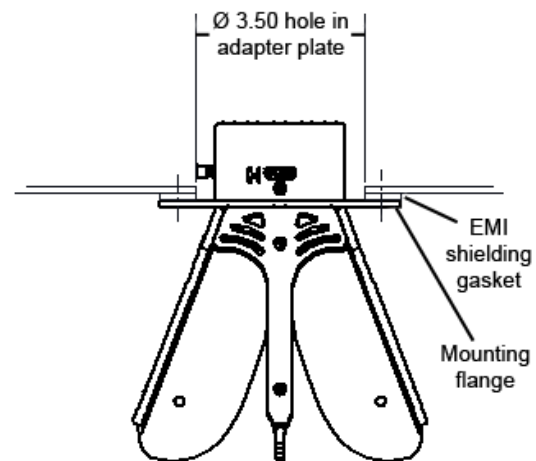
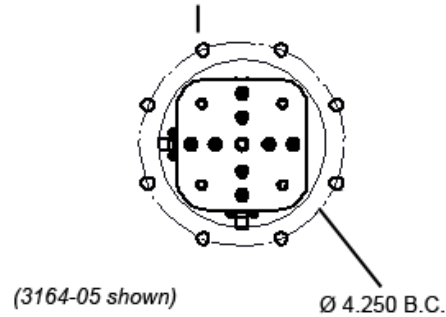

3164-06 CHAMBER WALL MOUNT, PAGE 1

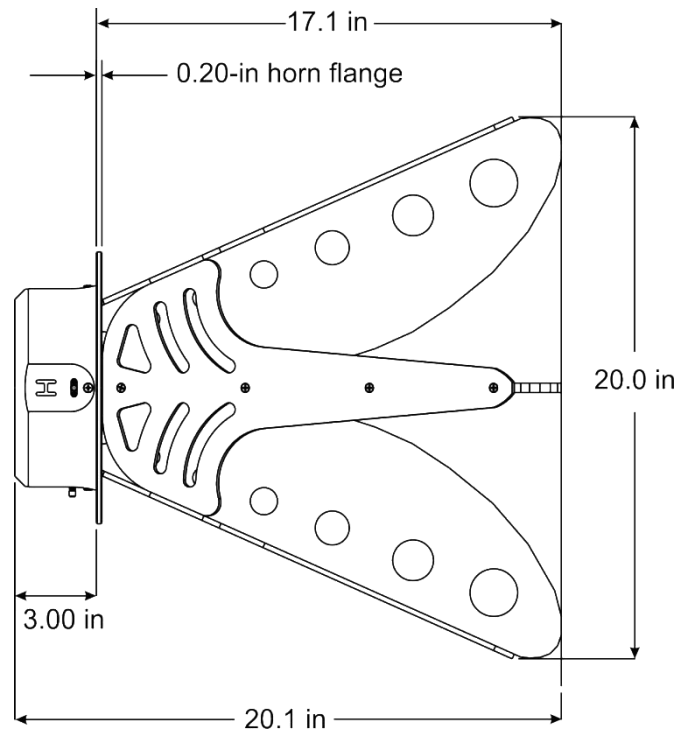

3164-06 CHAMBER WALL MOUNT, PAGE 2

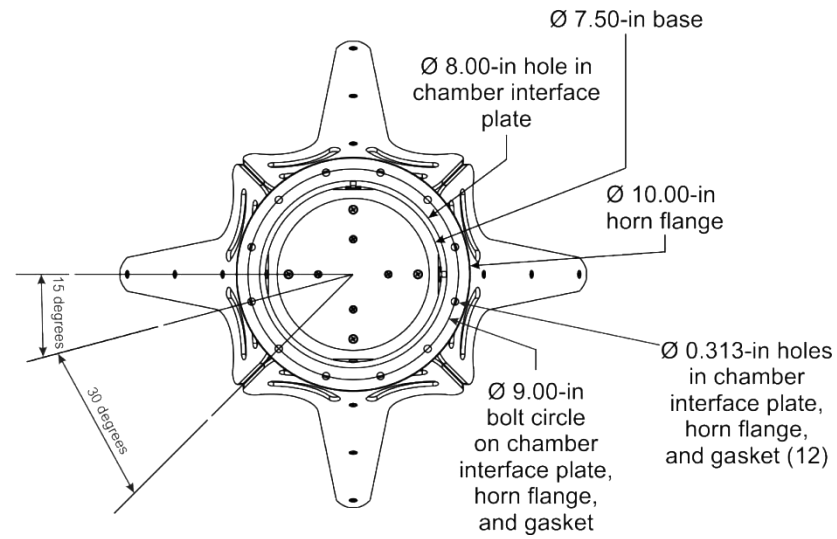
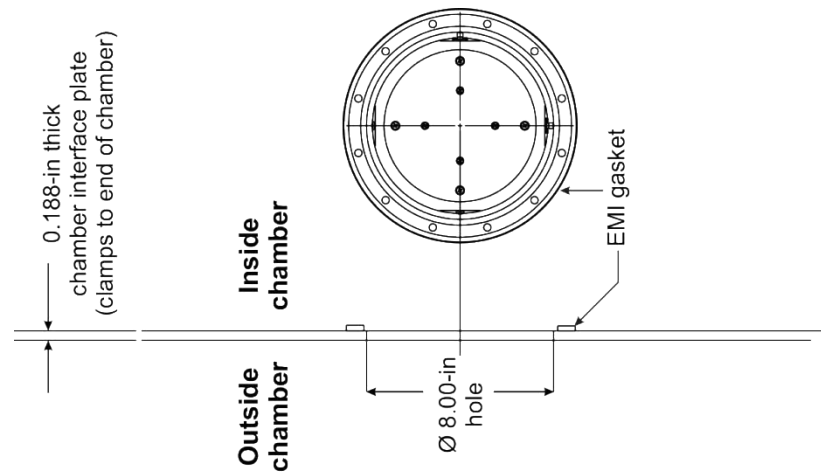

3164-08 / 3164-10 CHAMBER WALL MOUNT, PAGE 1



When mounted, the SMA connectors on the 3164-10 will be located inside the chamber and must be routed by cables to outside the chamber during installation.

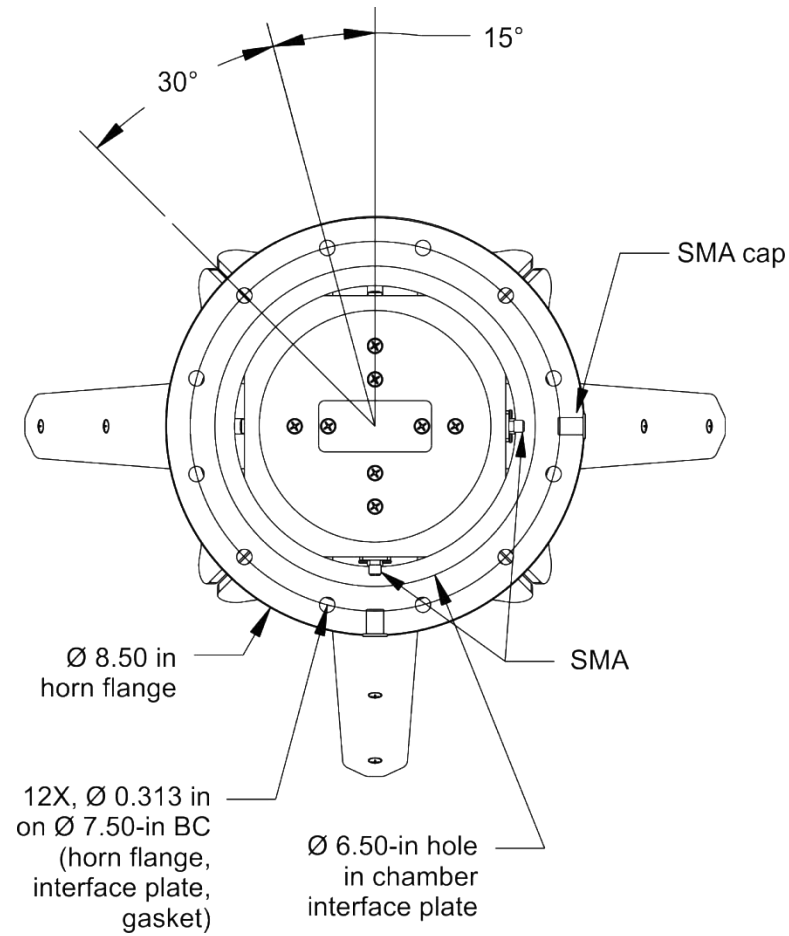

3164-08 / 3164-10 CHAMBER WALL MOUNT, PAGE 2

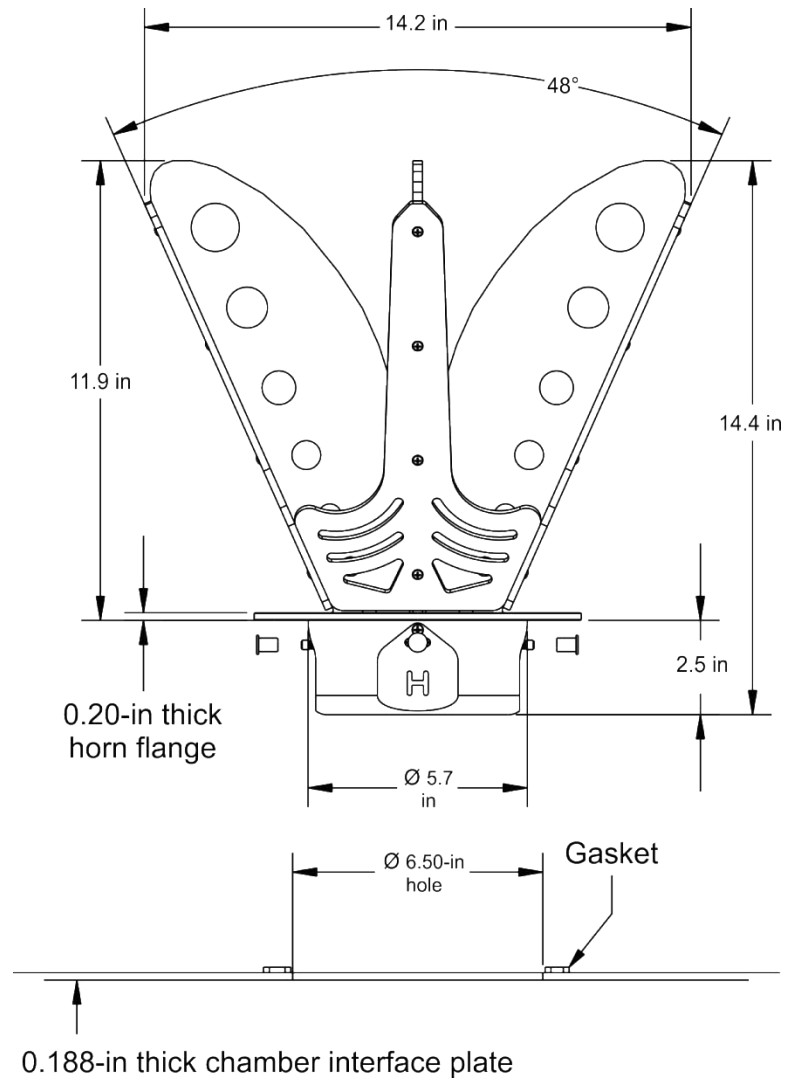

Bracket Mount Instructions

3164-05 BRACKET MOUNT

A mounting bracket (108071) attaches the 3164-05 onto a tripod or mast. The 108071 bracket attaches to the antenna backplate with a 1/4-20 thread knob, and includes an insert that fastens to a 1/4-20 thread screw on the tripod or mast.

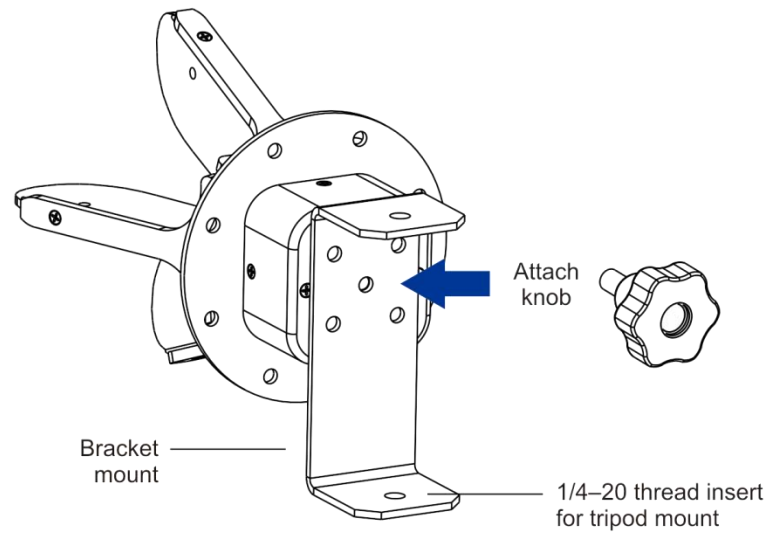

3164-06 / 3164-08 / 3164-10 BRACKET MOUNT

CAUTION

Due to the size and weight of these models, never mount the 3164-06, 3164-08, or 3164-10 onto a 4-TR Tripod.



All mentions in this section to a *tripod* refer exclusively to the ETS-Lindgren 7-TR tripod.

An L-shaped mounting bracket (106974) is included with the antenna. The 106974 bracket mounts the 3164-06 onto a boom and mounts the 3164-08/3164-10 onto a tripod or boom. Bracket hardware includes two screws, two wing nuts, and four metal washers.

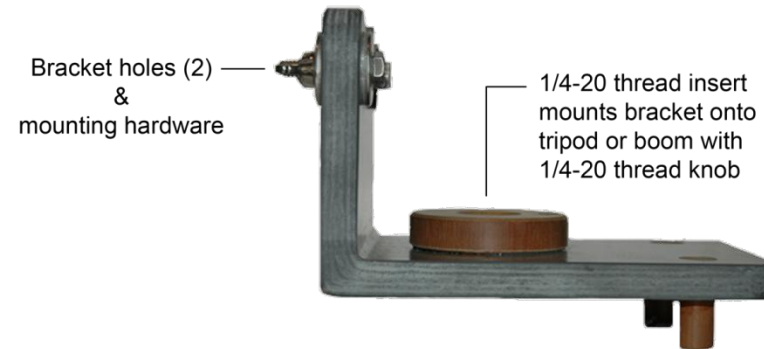

Included with the 106974 bracket are two mounting adapters:

- 1/4–20 thread insert that fastens to a 1/4–20 screw on the tripod or boom
- 1/4–20 thread knob that attaches the bracket to the tripod or boom

Vertical plane

Using the **V** and **H** indicators on the antenna, orient the antenna along the vertical and horizontal planes, with one connector at the top, pointing up.

Horizontal plane

3164-06 shown with mounting bracket attached

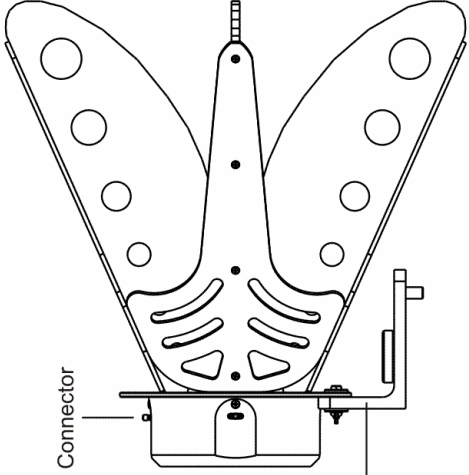

Bracket attaches behind adapter plate on 3164-06

3164-08 shown with mounting bracket attached

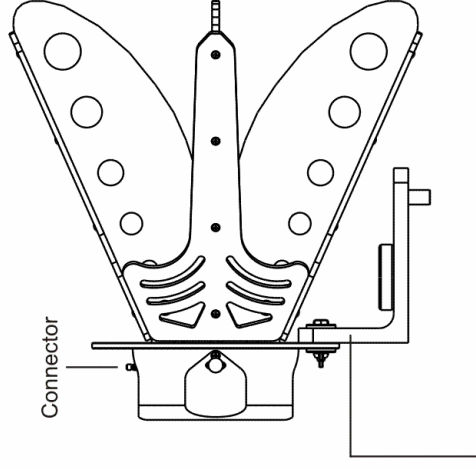

Bracket attaches in front of adapter plate on 3164-08 / 3164-10

To attach the 106974 mounting bracket:

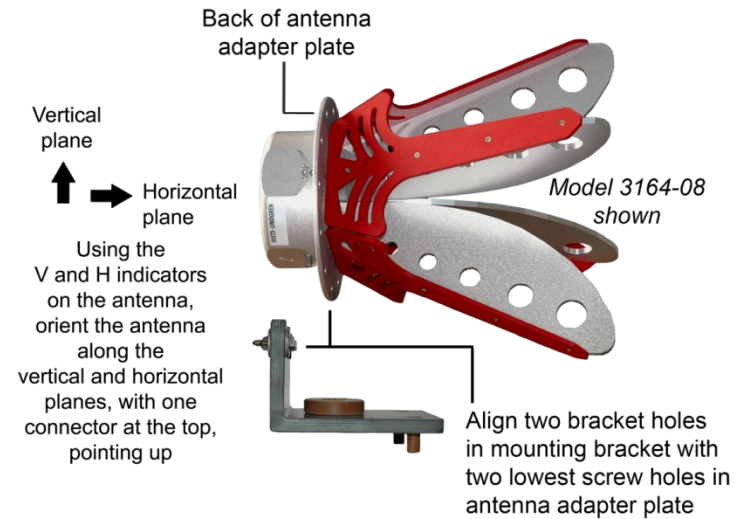

1. Place the antenna in a stable position and location to prevent it from falling or rolling while attaching the bracket.
2. **Orient the antenna:** Use the **V** (vertical) and **H** (horizontal) marks on the antenna to orient the antenna along the vertical and horizontal planes with one connector at the top, pointing up.
3. With the antenna oriented, align the two bracket holes in the mounting bracket with the two lowest screw holes in the antenna adapter plate.
 - **For 3164-06**, align the 106974 mounting bracket on the back of the antenna adapter plate. See page 34 for an illustration.
 - **For 3164-08 / 3164-10**, align the 106974 mounting bracket on the front of the antenna adapter plate on the. See page 34 for an illustration.
4. Thread a washer onto a screw. From the front of the antenna adapter plate, insert the screw and washer through one of the bracket holes.
5. On the back of the mounting bracket, thread a washer onto the screw, and then tighten a wing nut onto the screw.
6. Repeat for the remaining bracket hole.

3164-11 BRACKET MOUNT

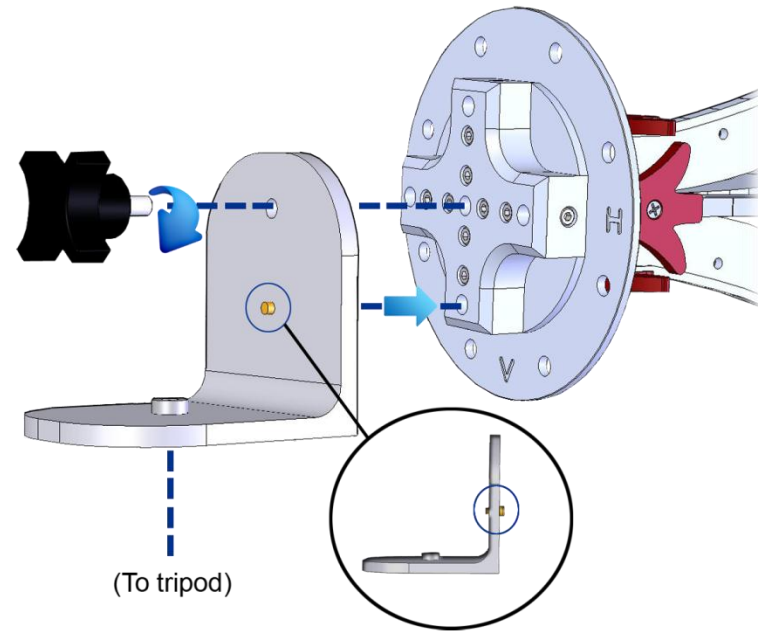

Additional Mounting Instructions for 3164-05

3164-05 BACKPLATE MOUNT

As found with traditional antennas that cover the same frequency range, the backplate of the 3164-05 provides four 10-32 threaded holes for mounting.

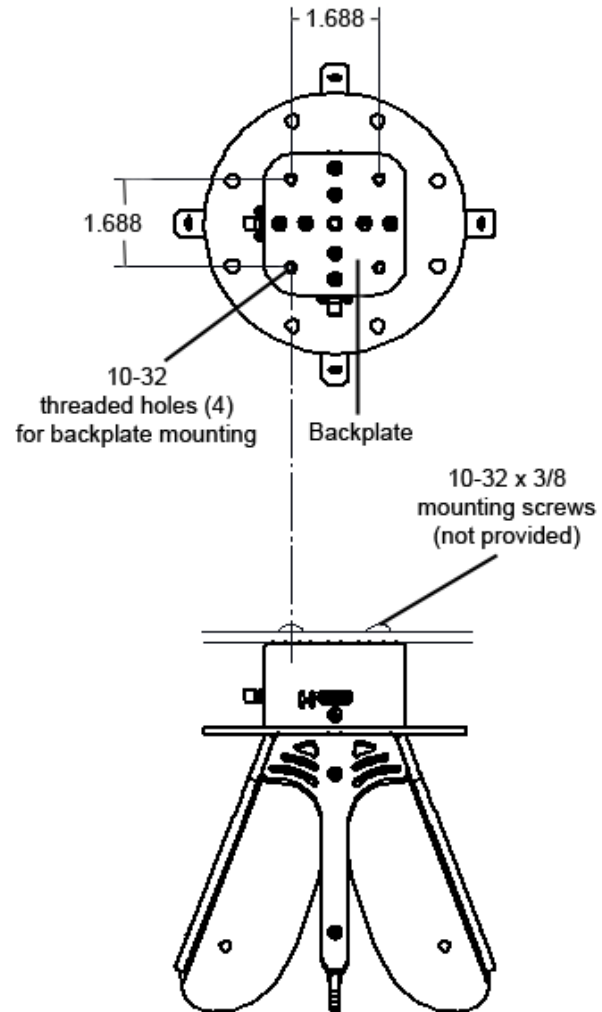

3164-05 CENTER ROTATION MOUNT

A stinger shaft can be attached to the 3164-05 for mounting to stinger compatible tripods, such as the 7-TR. The stinger screws into the antenna backplate with a 1/4-20 set screw.

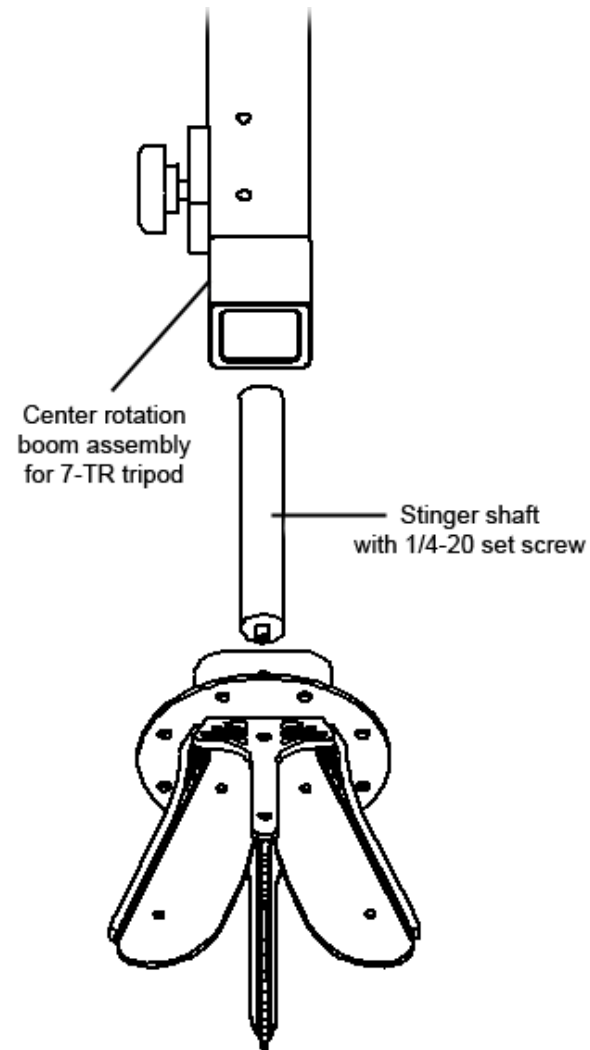

Summary of Mounting Options

	Chamber Wall	4-TR	7-TR, Mast	2x2 Boom
3164-05	Adapter plate (flange)	108071 Mounting bracket	108070 Stinger	
3164-06		NA	106974 Mounting bracket	
3164-08		NA		
3164-10		NA		
3164-11		119430 Mounting bracket (includes knob)		

4-TR MOUNTING (3164-05, 3164-11)

CAUTION

Do not mount the 3164-06, 3164-08, or 3164-10 onto a 4-TR Tripod.

Only the 3164-05 and 3164-11 can be mounted to a 4-TR.

7-TR, MAST MOUNTING (3164-06, 3164-08, 3164-10)



Mast refers to 2070 Series, 2075, and 2175 Antenna Towers.

7-TR refers to these booms:

- 109042 boom—Straight boom; for general antenna mounting on a 7-TR
- 108983 boom—Offset boom; for general antenna mounting on a 7-TR with pneumatic or manual polarization; can also be used to mount stinger-type antennas

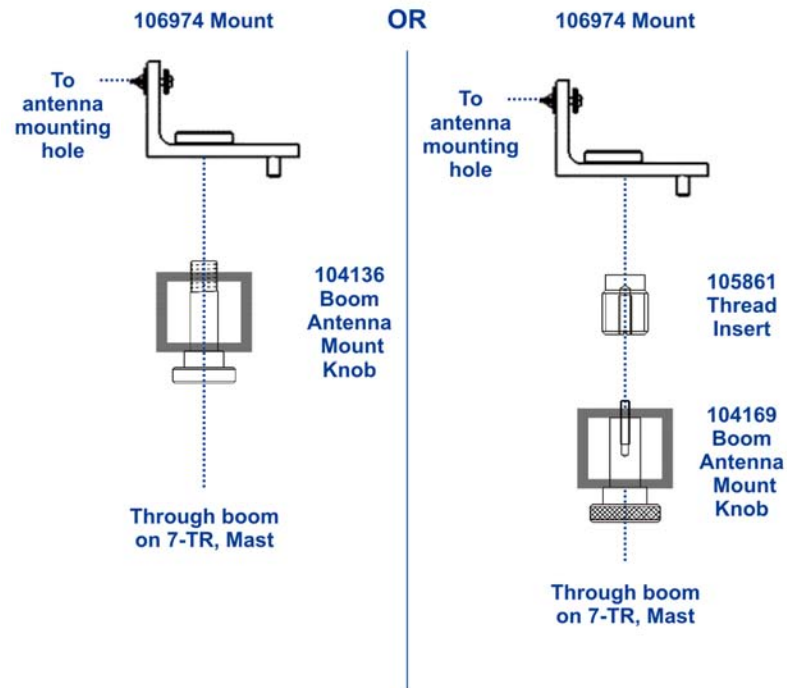

2x2 BOOM MOUNTING (3164-06, 3164-08, 3164-10)



2x2 *boom* refers to a typical 2-inch by 2-inch boom.

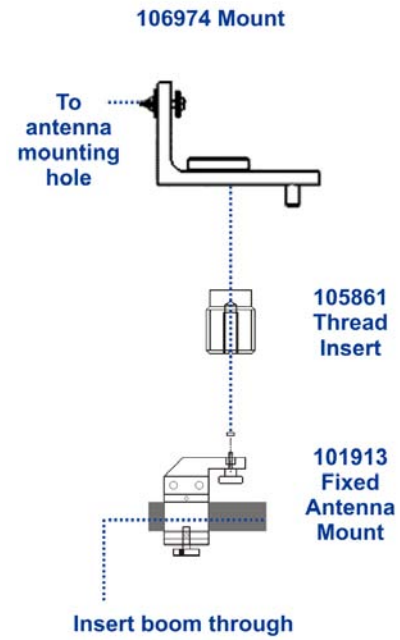

This page intentionally left blank.

6.0 Model 3164-05 Typical Data

Model 3164-05 Gain Measured Per SAE 958 Method

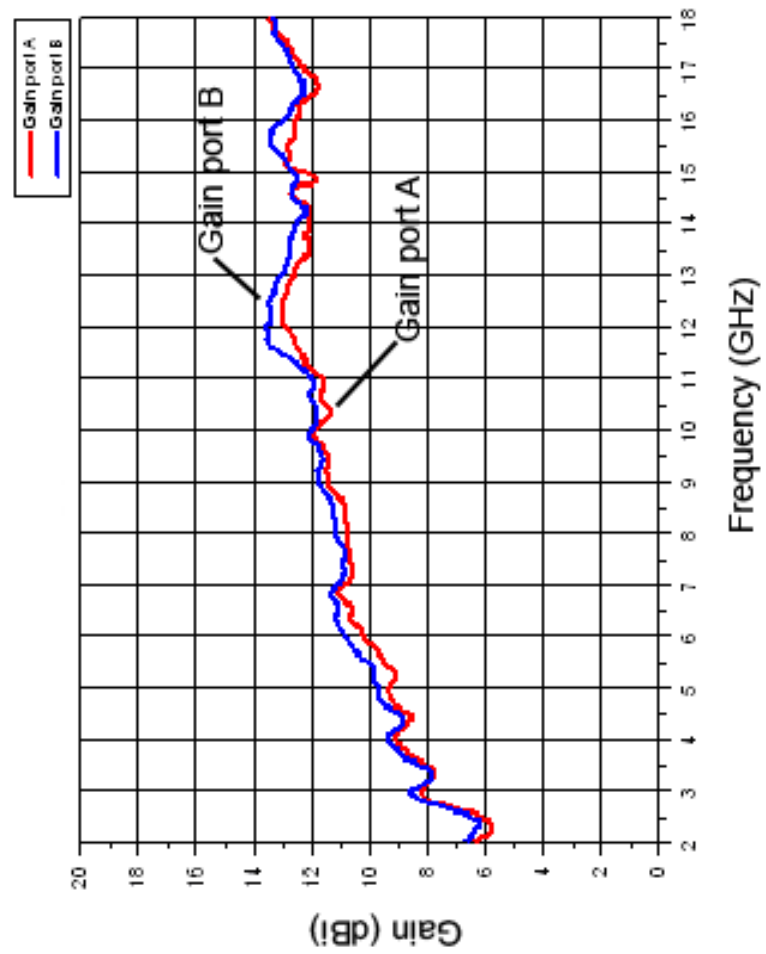

Model 3164-05 VSWR – Both Ports

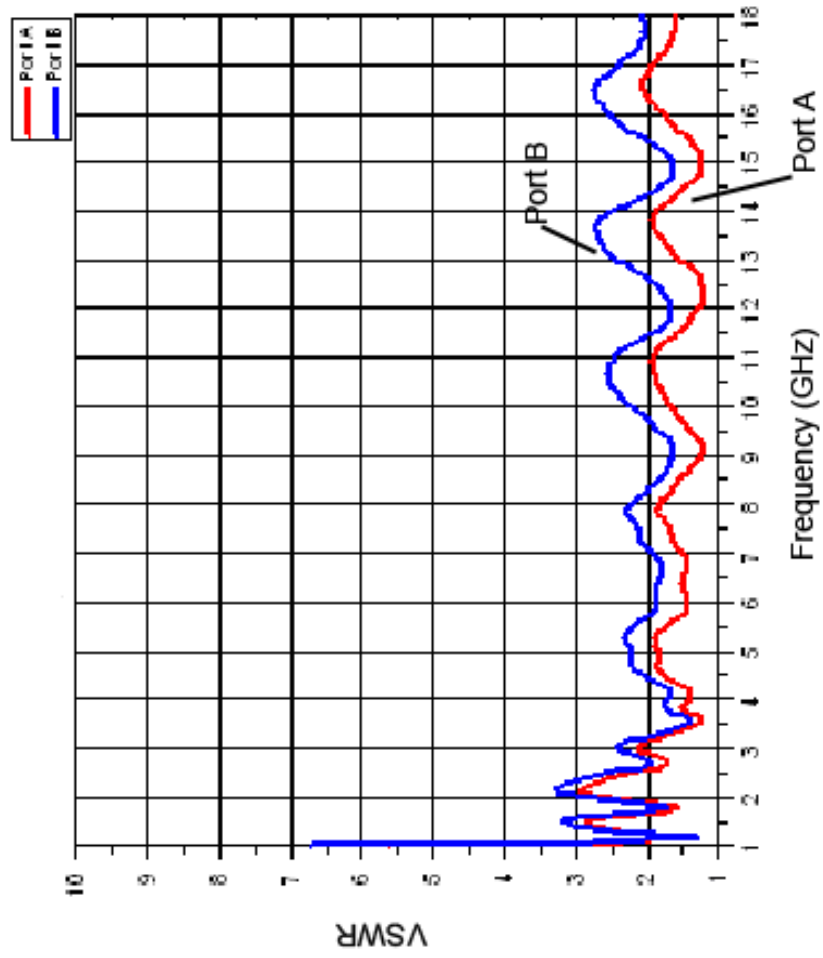

Model 3164-05 Cross-Port Isolation

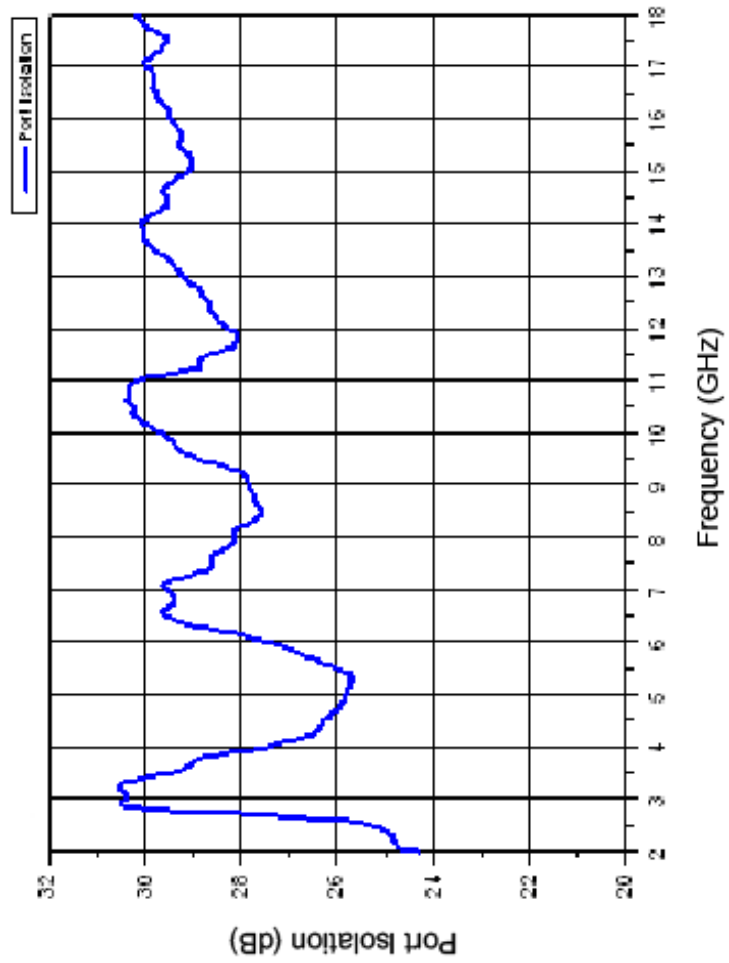

Model 3164-05 Half-Power Beamwidth

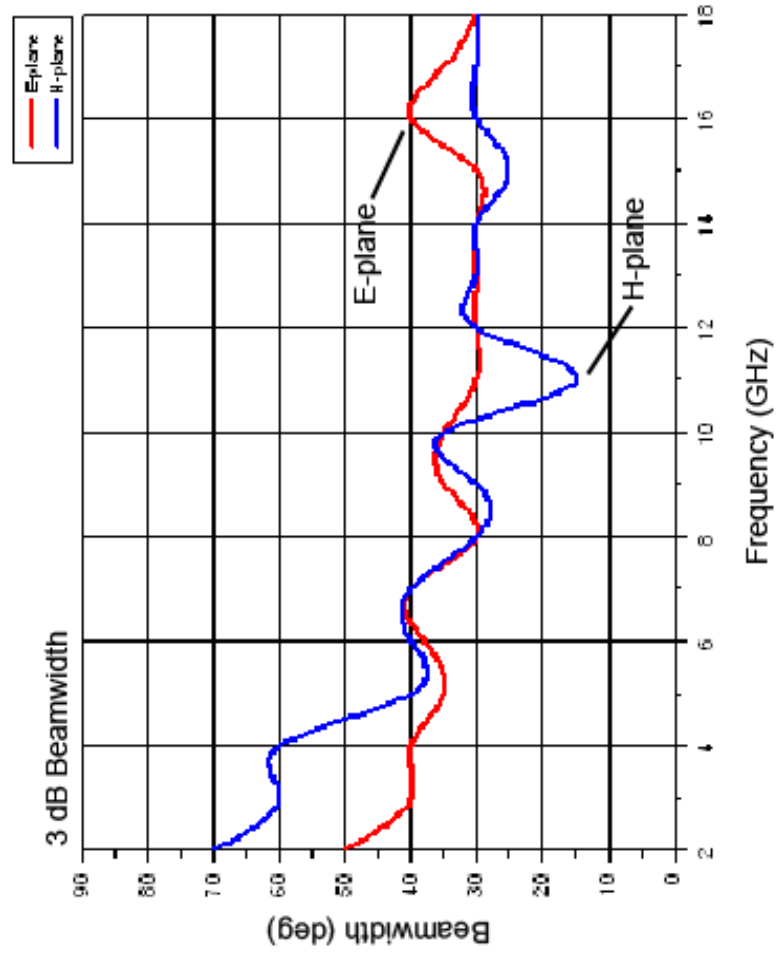

Model 3164-05 10 dB Beamwidth

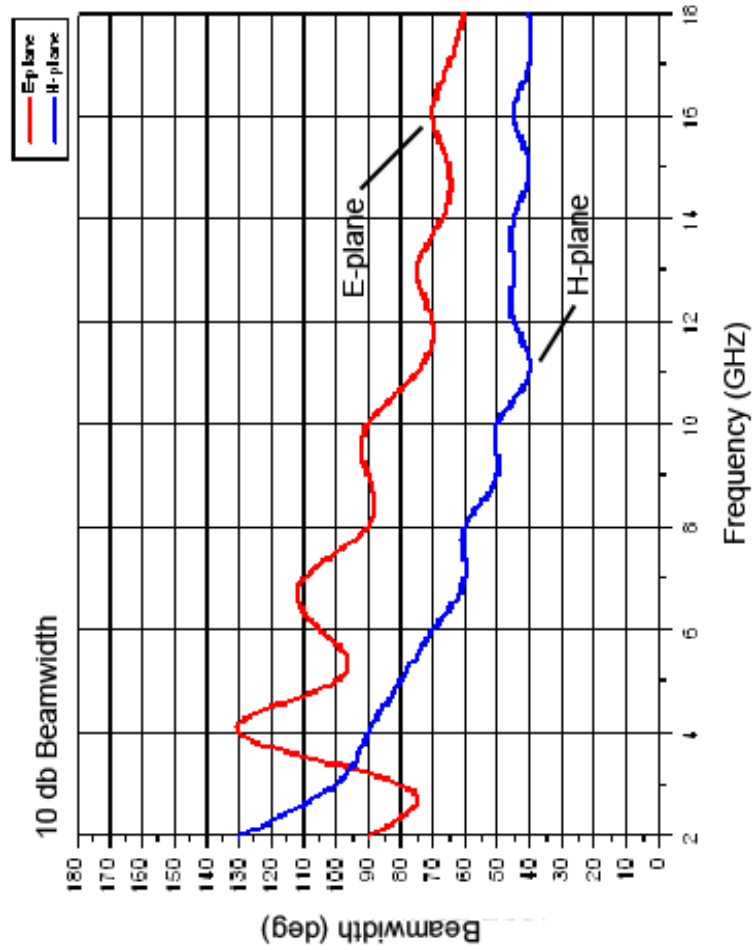

This page intentionally left blank.

7.0 Model 3164-05 Typical Radiation Patterns

Model 3164-05 at 2 GHz

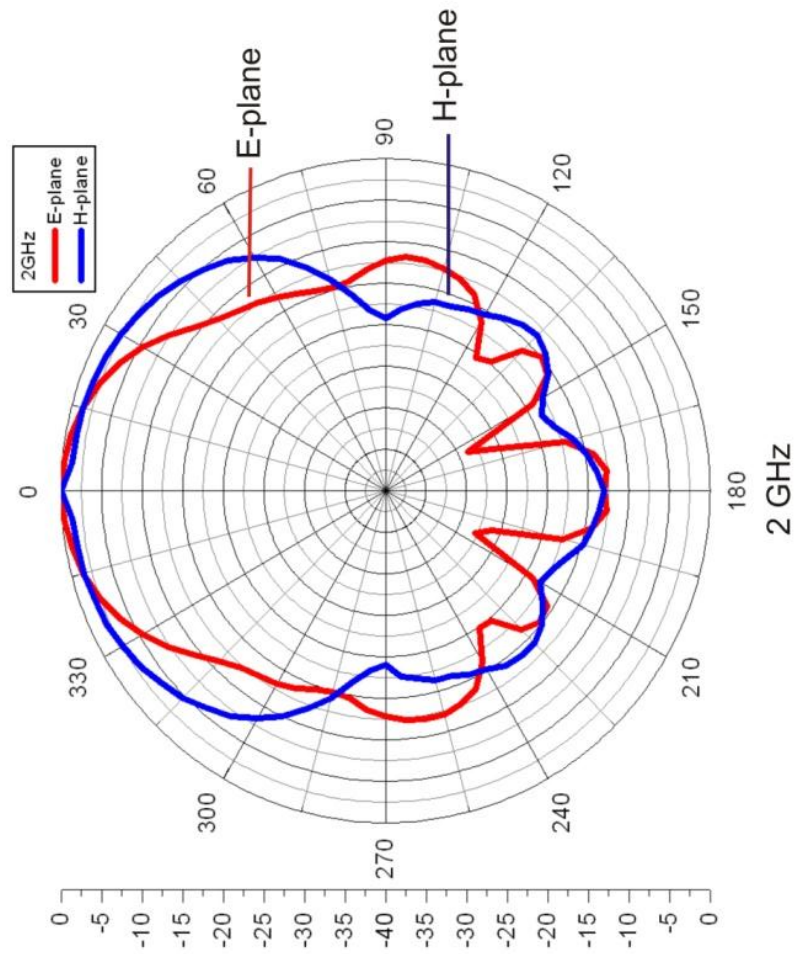

Model 3164 05 at 3 GHz

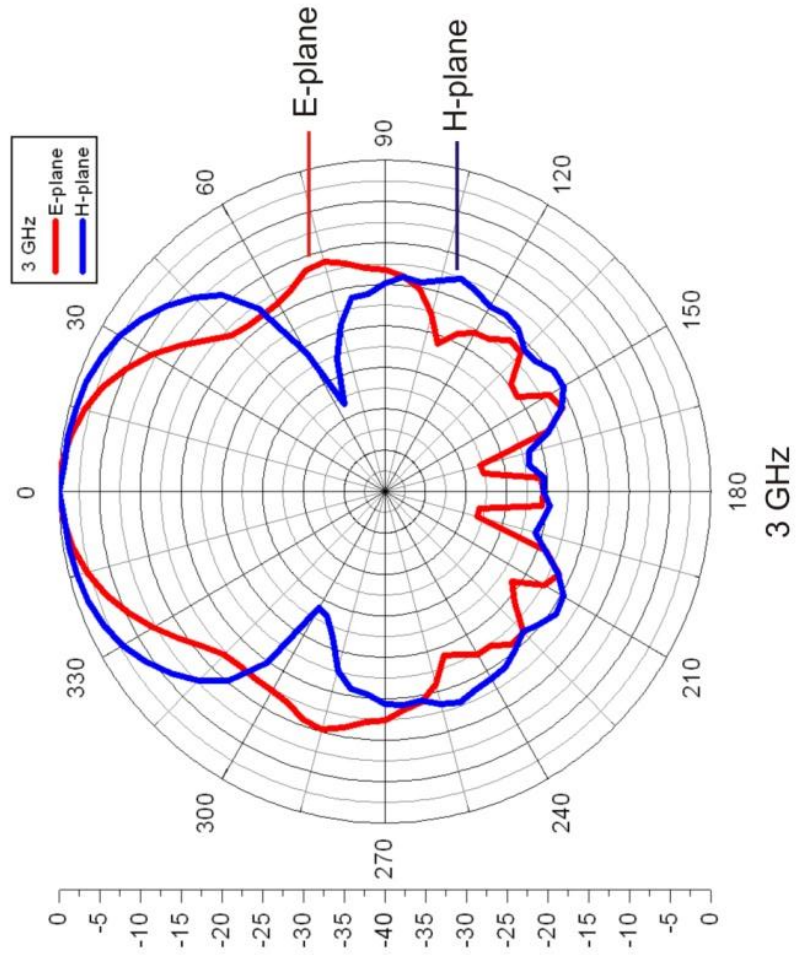

Model 3164-05 at 4 GHz

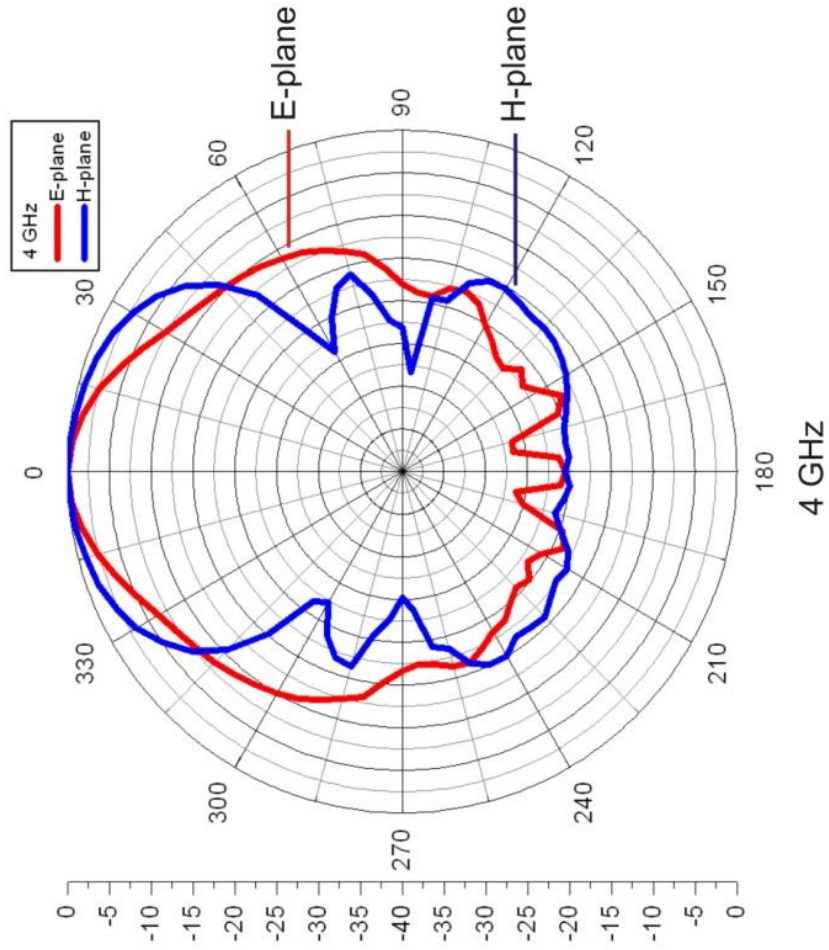

Model 3164-05 at 5 GHz

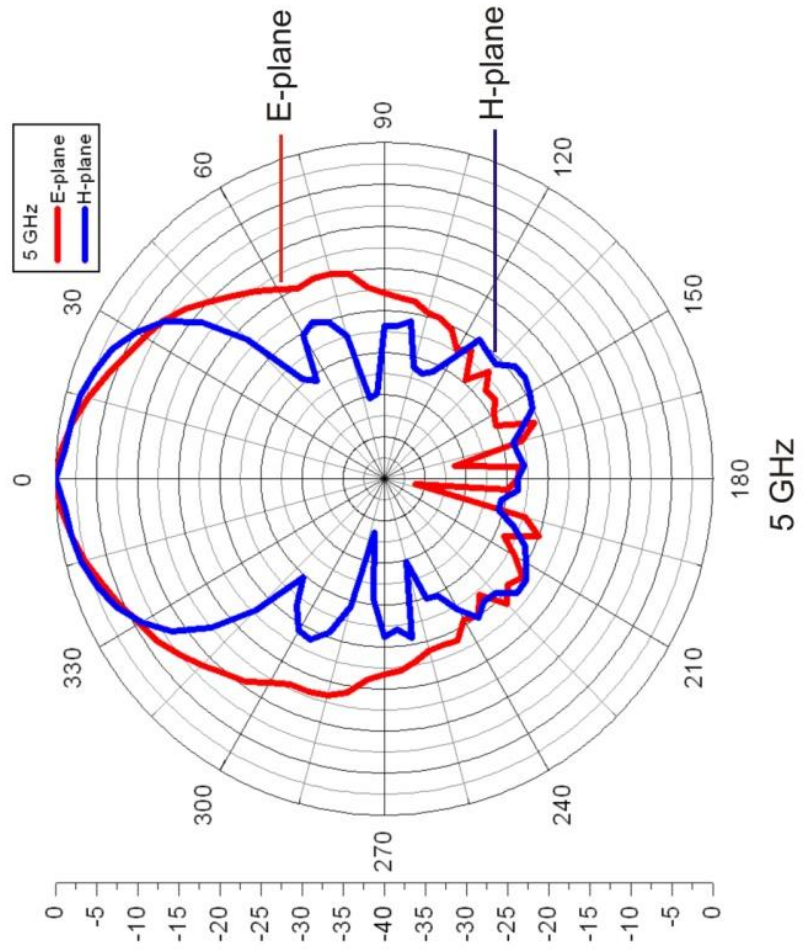

Model 3164-05 at 6 GHz

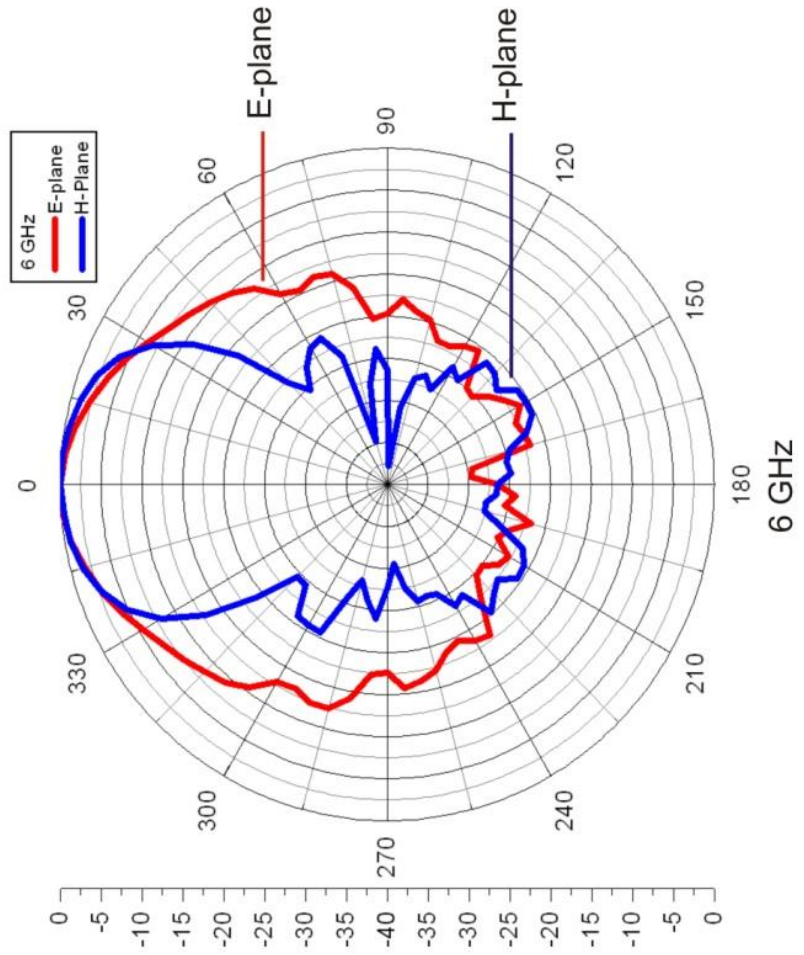

Model 3164-05 at 7 GHz

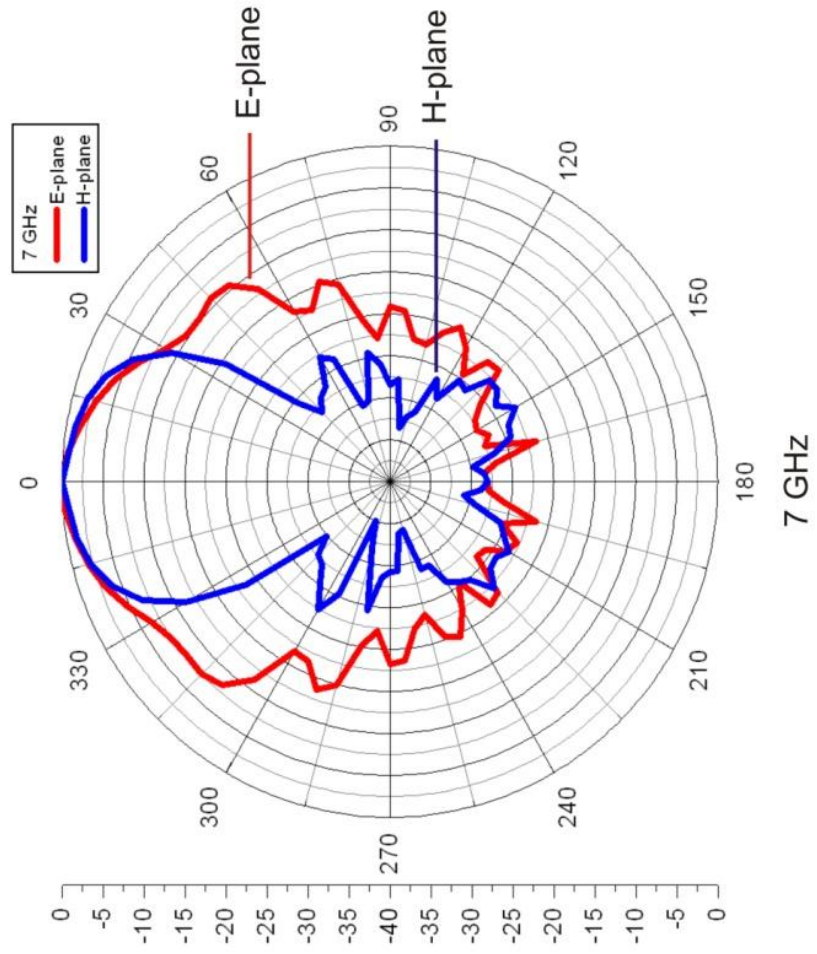

Model 3164-05 at 8 GHz

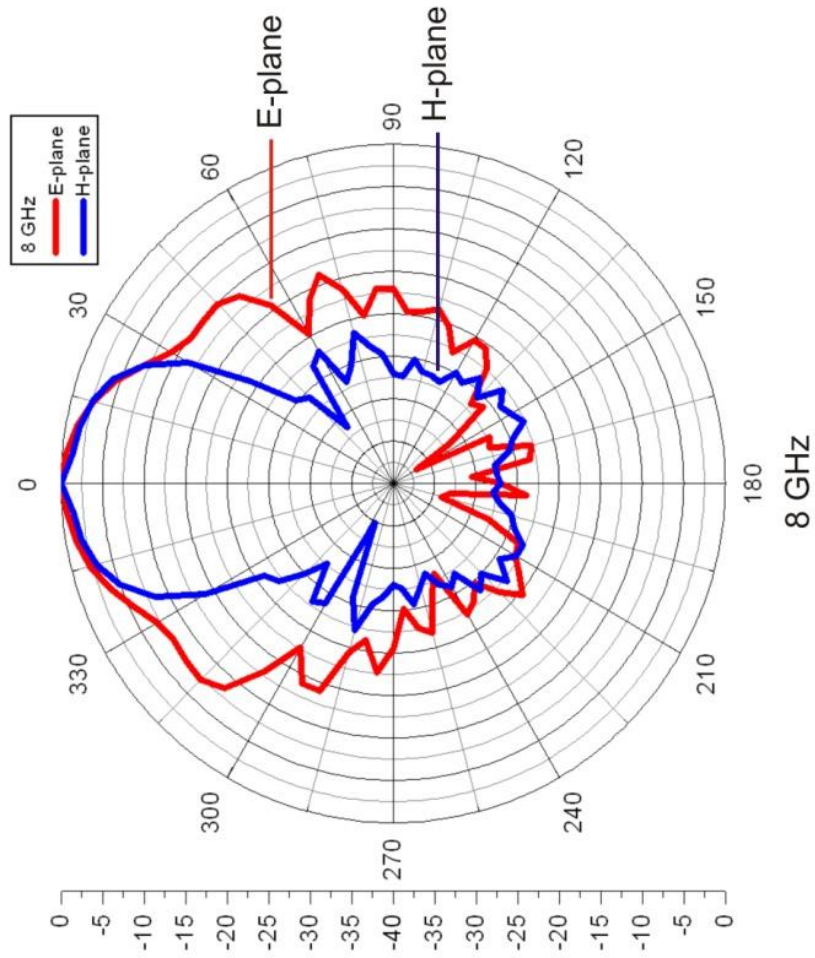

Model 3164-05 at 9 GHz

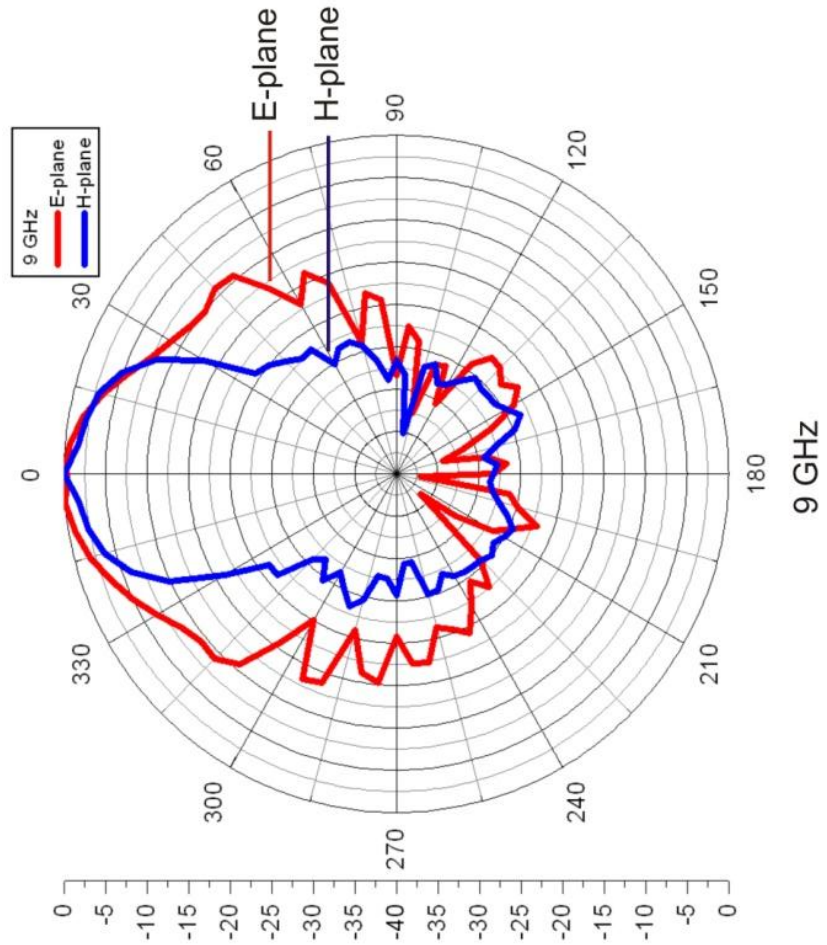

Model 3164-05 at 10 GHz

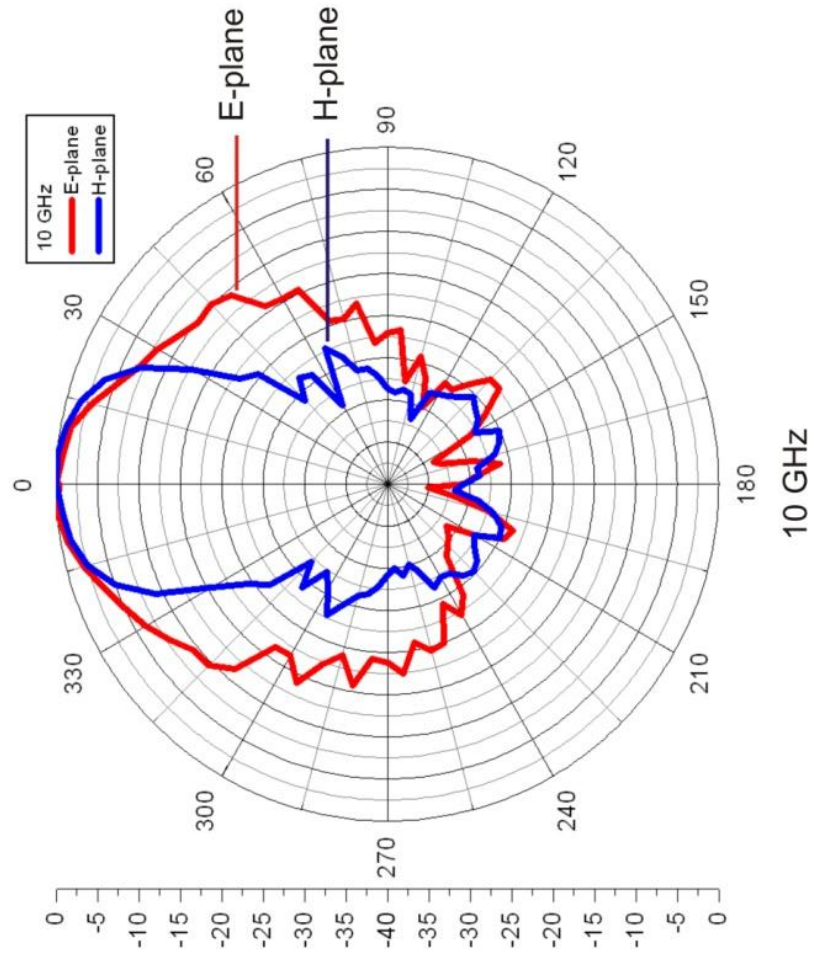

Model 3164-05 at 11 GHz

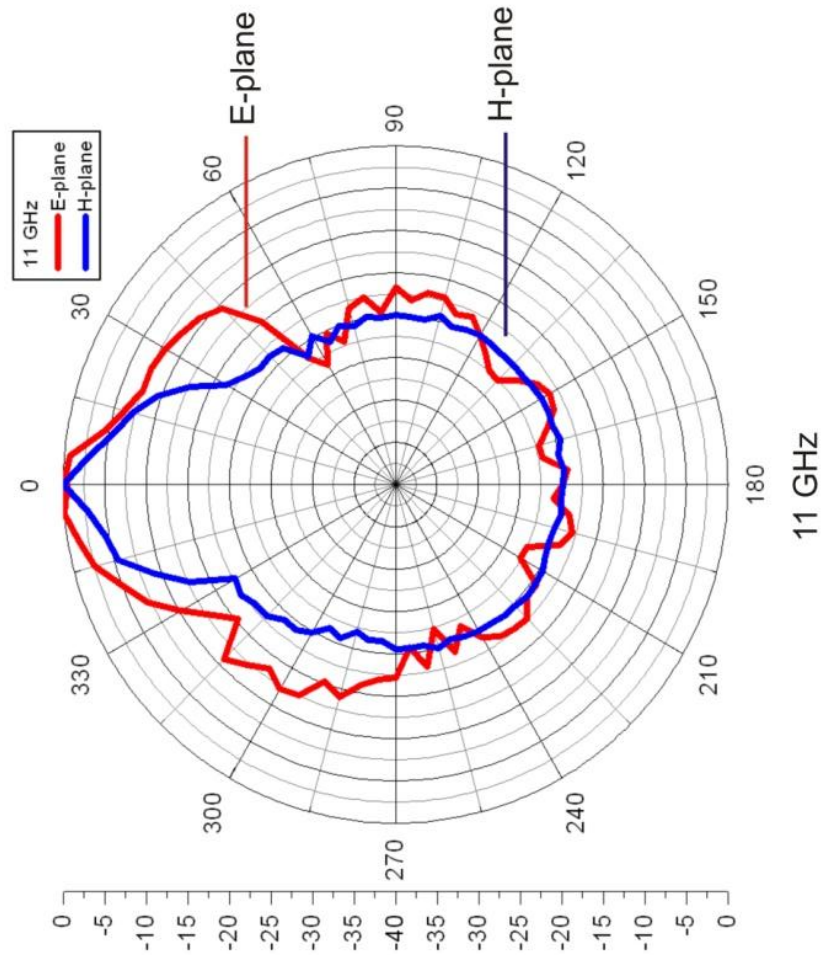

Model 3164-05 at 12 GHz

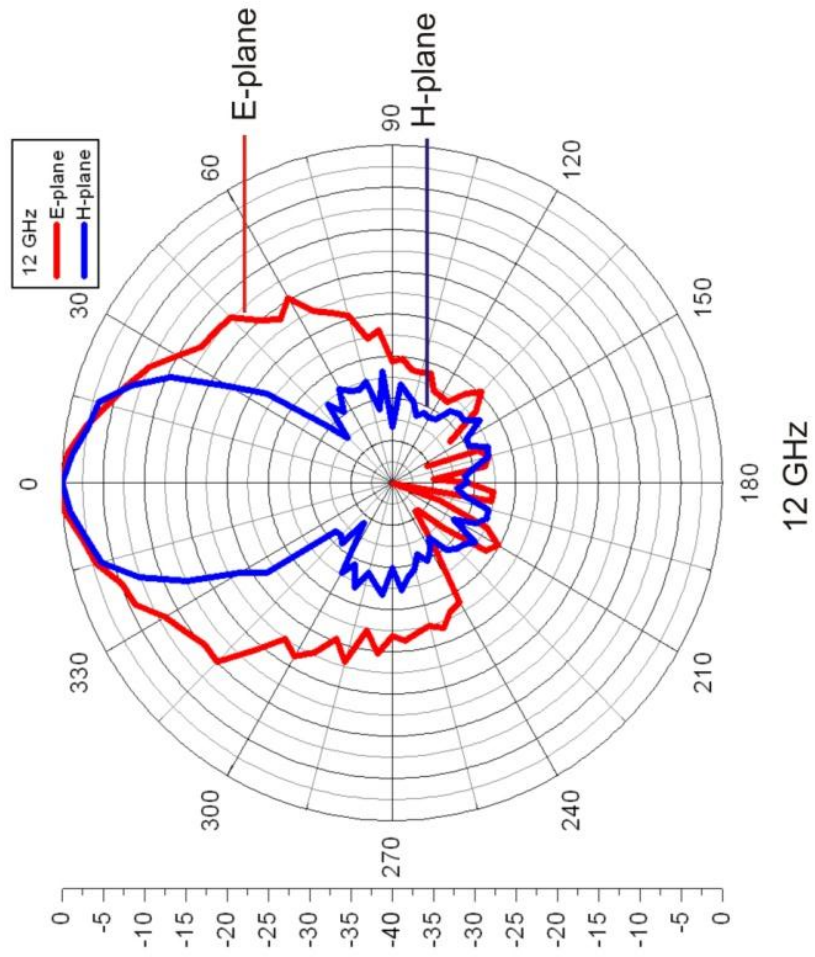

Model 3164-05 at 13 GHz

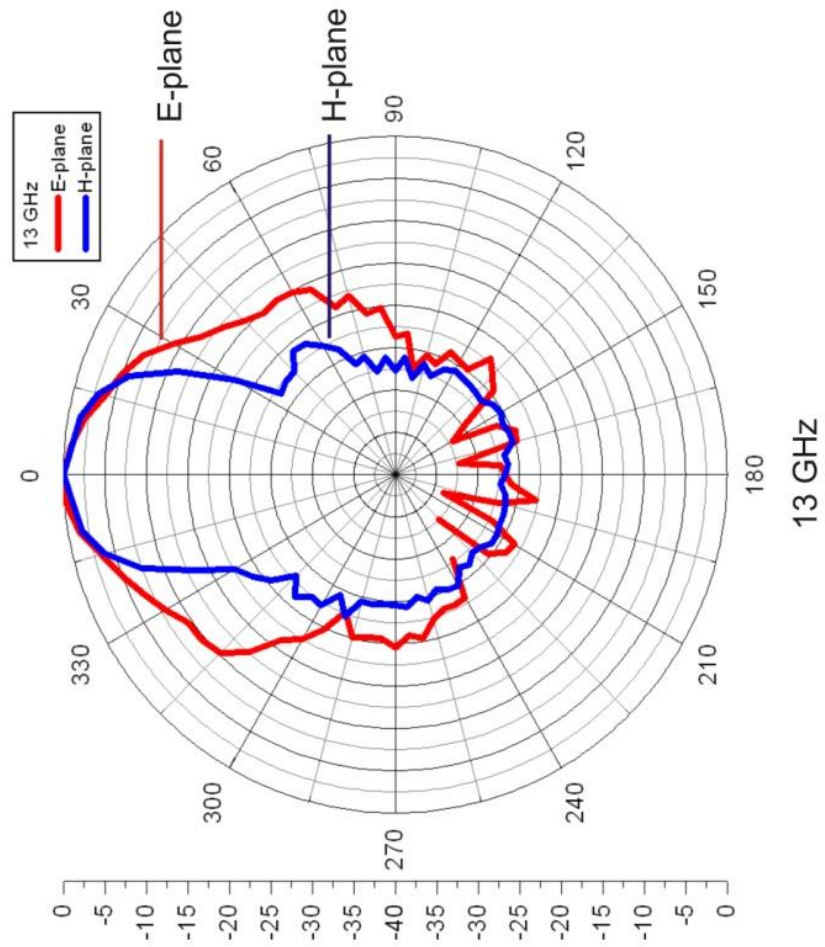

Model 3164-05 at 14 GHz

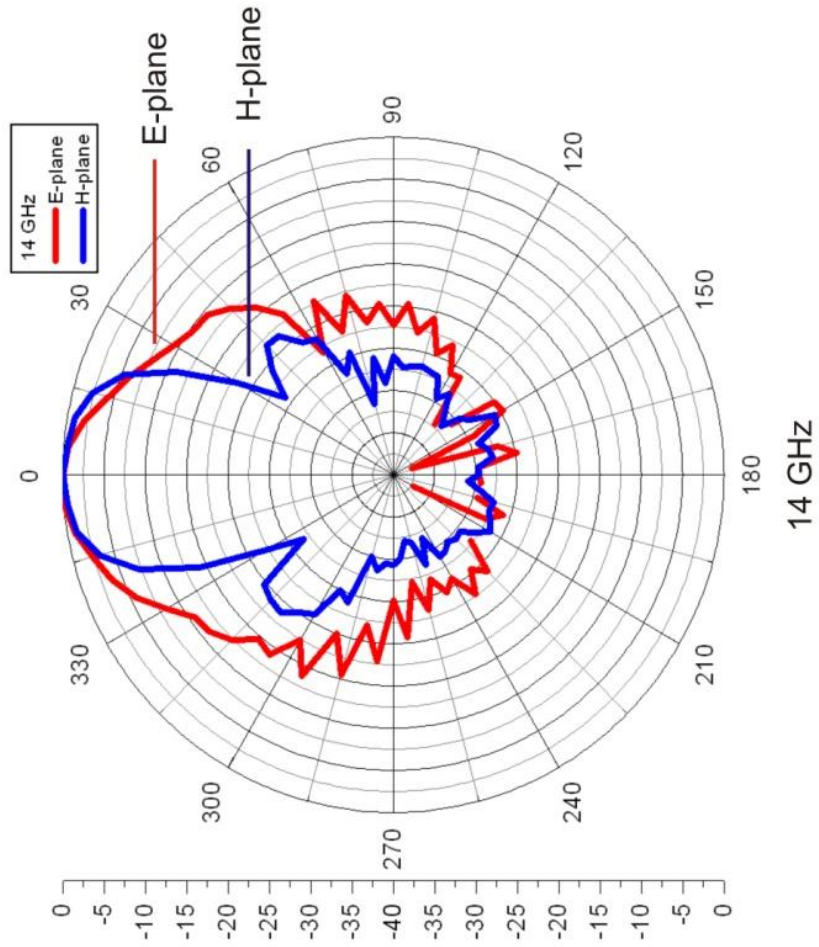

Model 3164-05 at 15 GHz

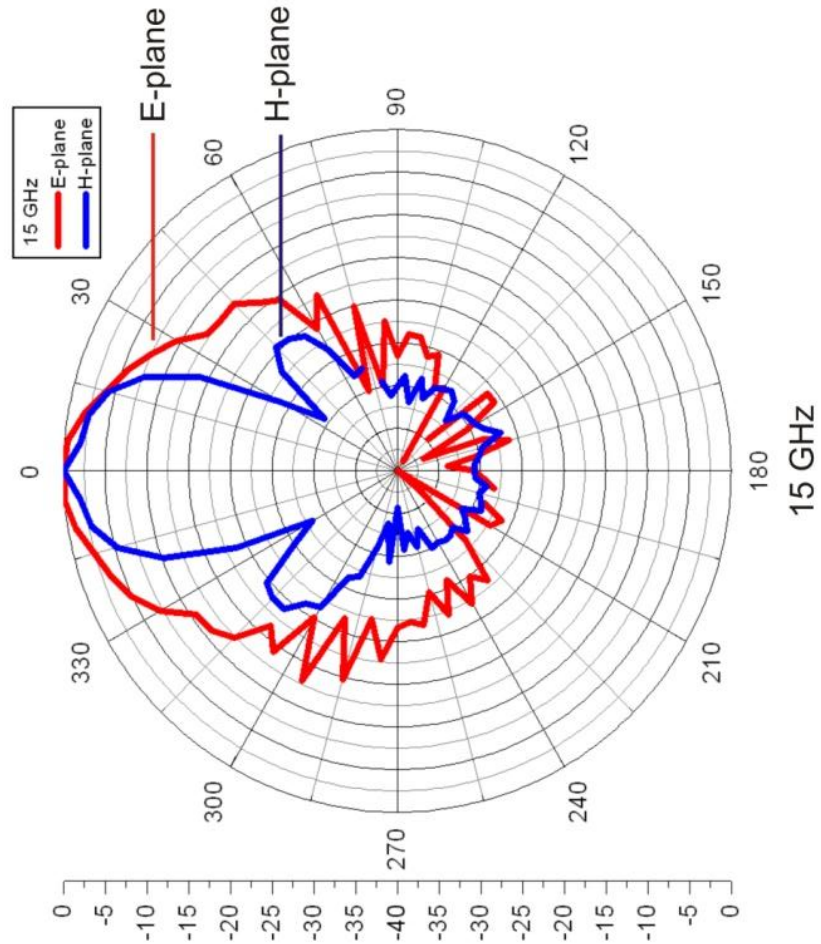

Model 3164-05 at 16 GHz

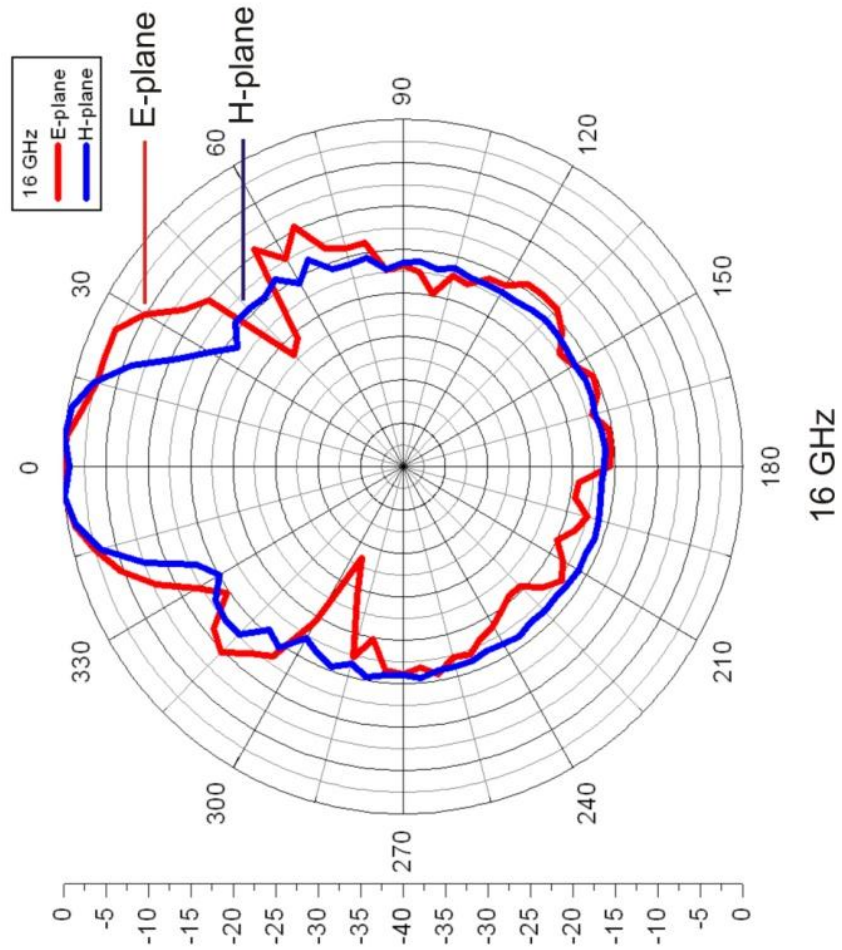

Model 3164-05 at 17 GHz

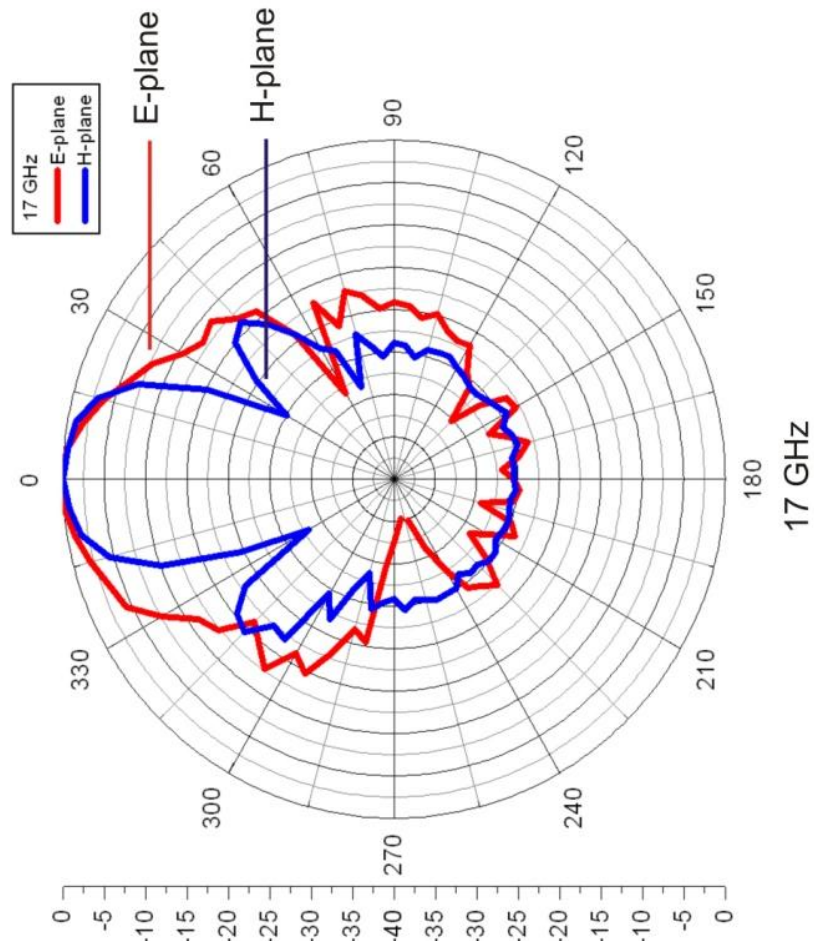

Model 3164-05 at 18 GHz

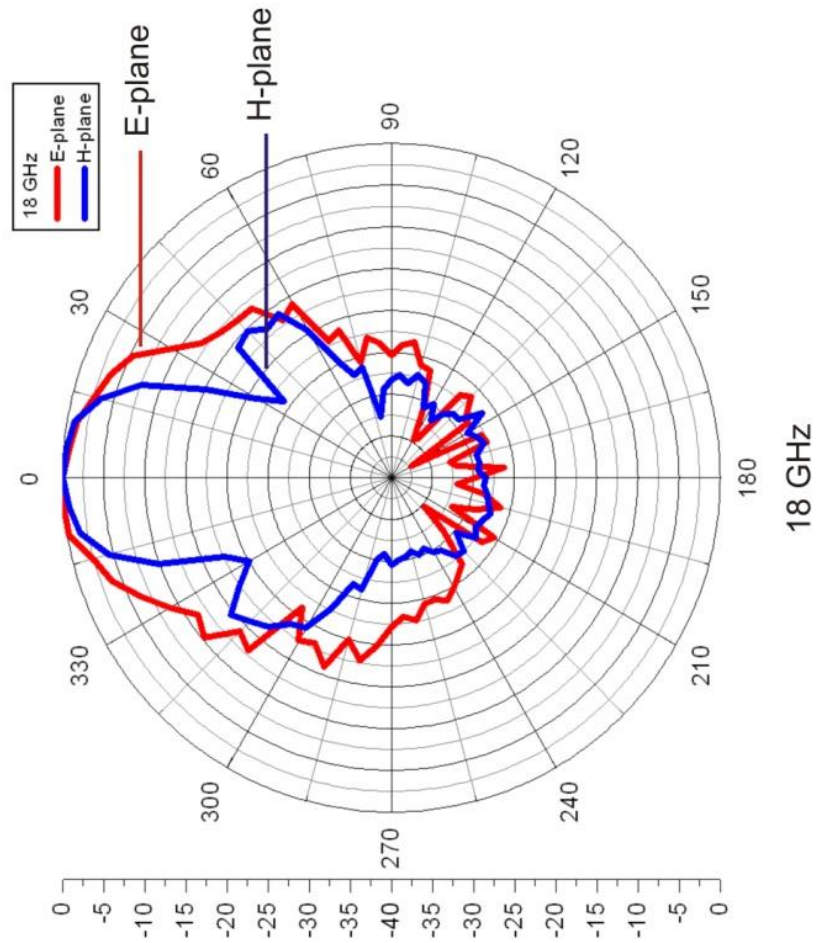

This page intentionally left blank.

8.0 Model 3164-06 Typical Data

Model 3164-06 Gain

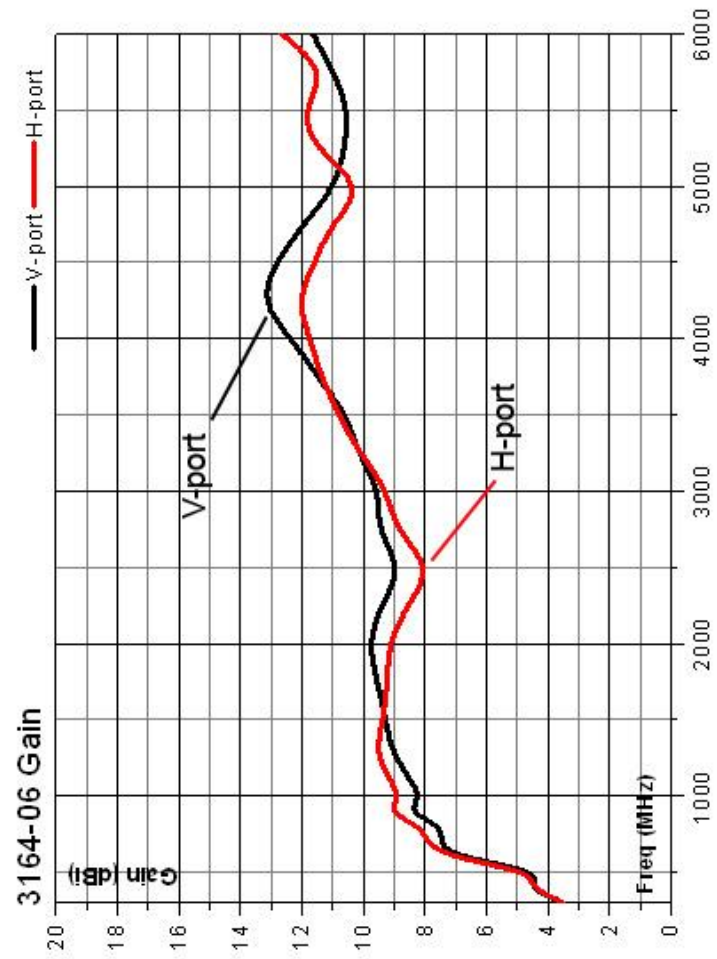

Model 3164-06 VSWR

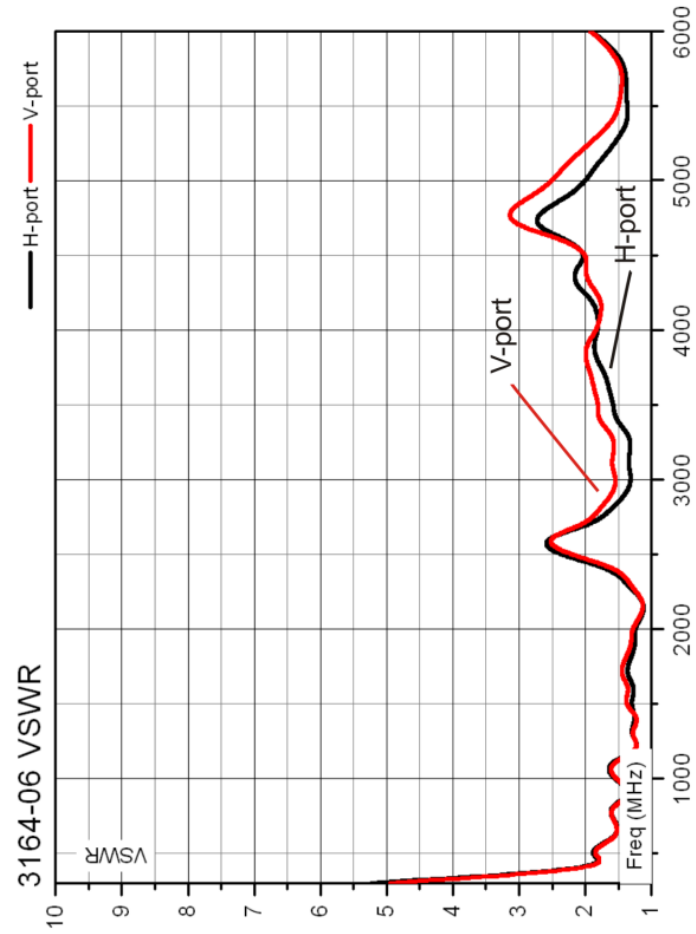

Model 3164-06 3 dB Half-Power Beamwidth

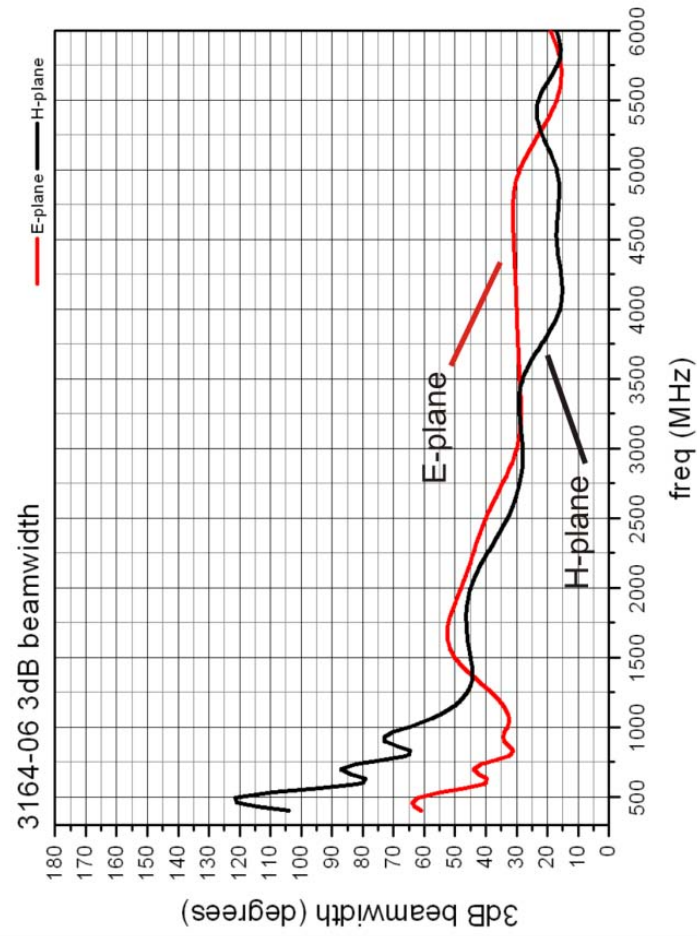

Model 3164-06 Cross-Port Isolation

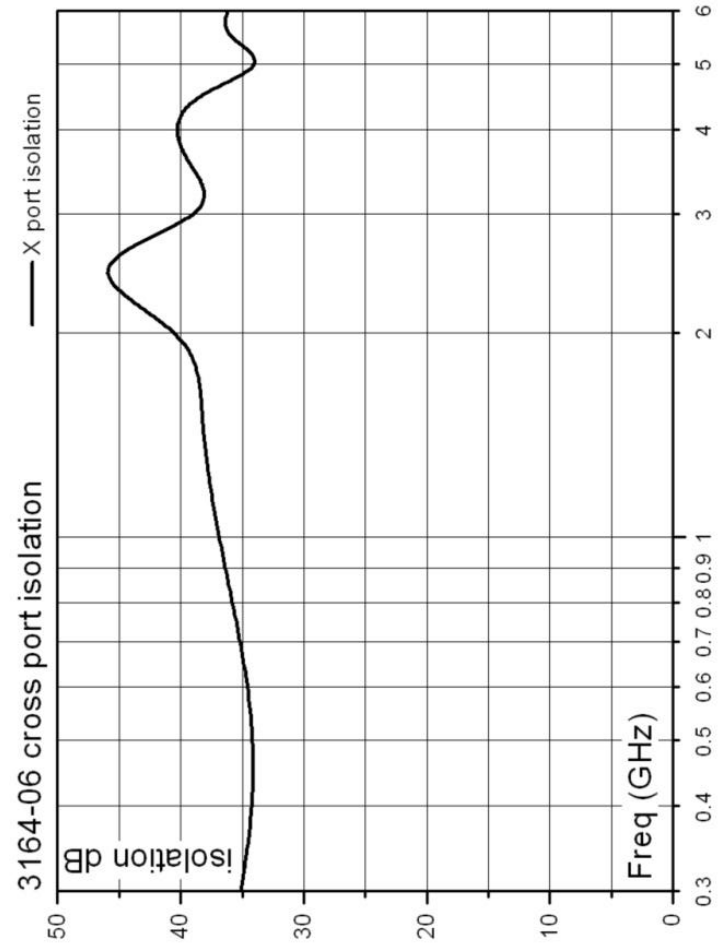

9.0 Model 3164-06 Typical Radiation Patterns

Model 3164-06 at 400 MHz–600 MHz

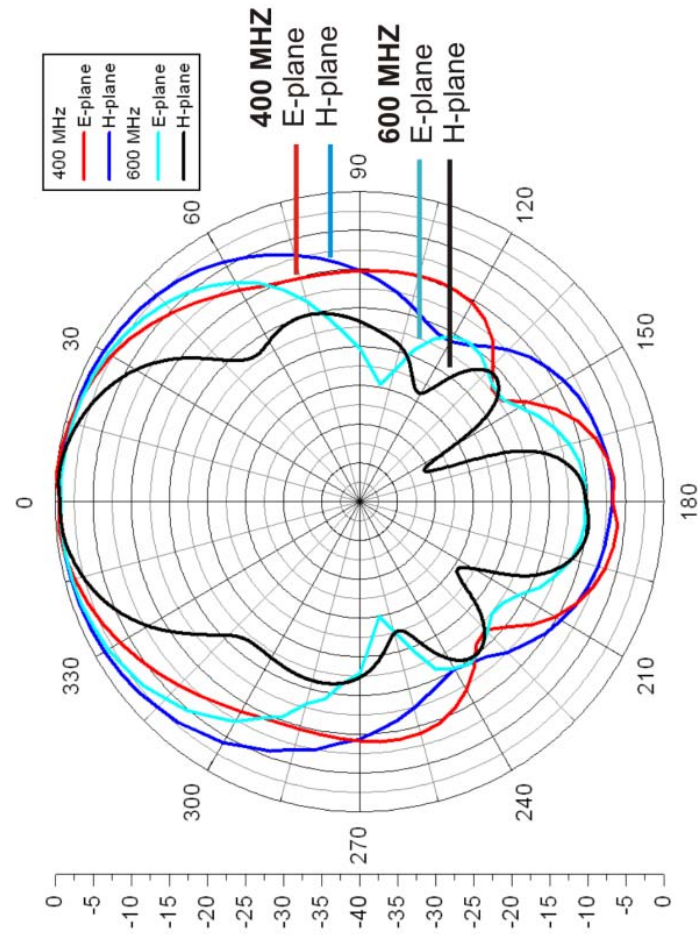

Model 3164-06 at 800 MHz–1000 MHz

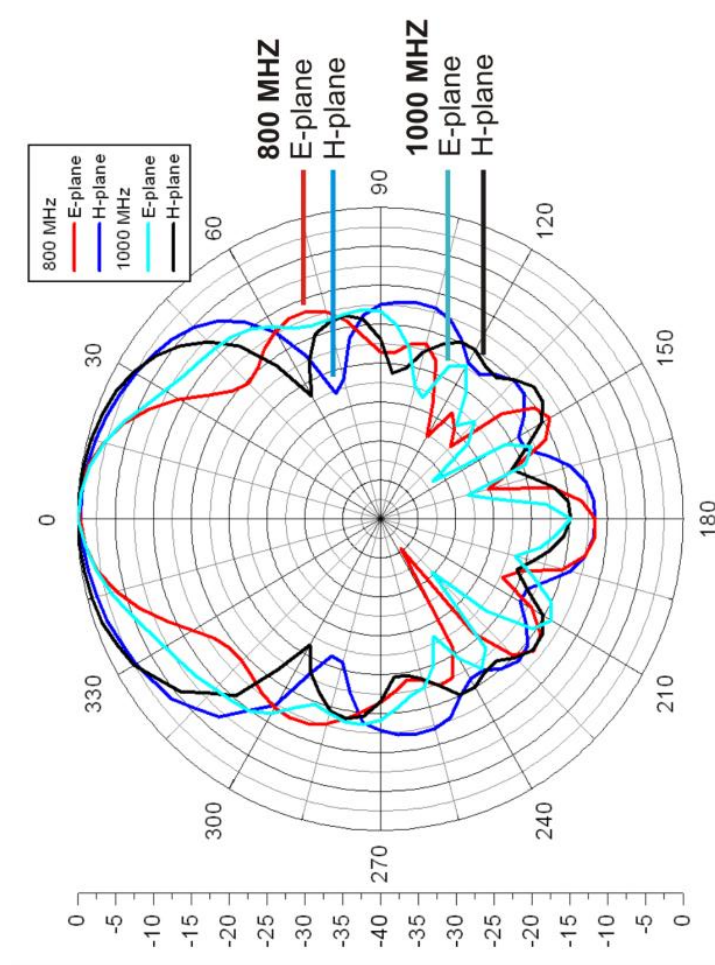

Model 3164-06 at 2000 MHz–3000 MHz

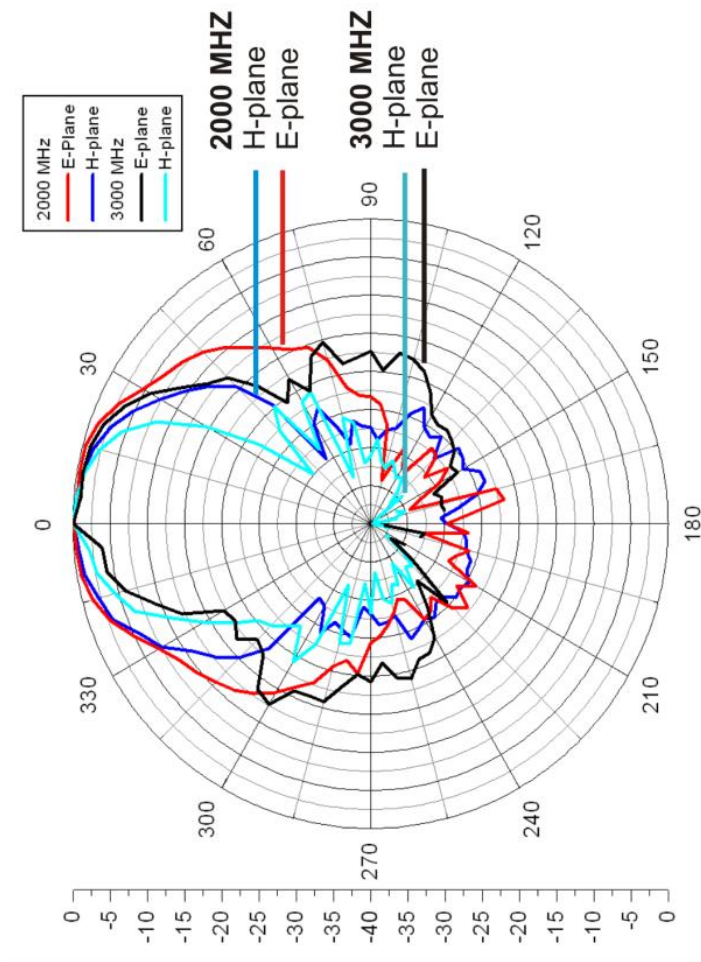

Model 3164-06 at 4000 MHz–5000 MHz

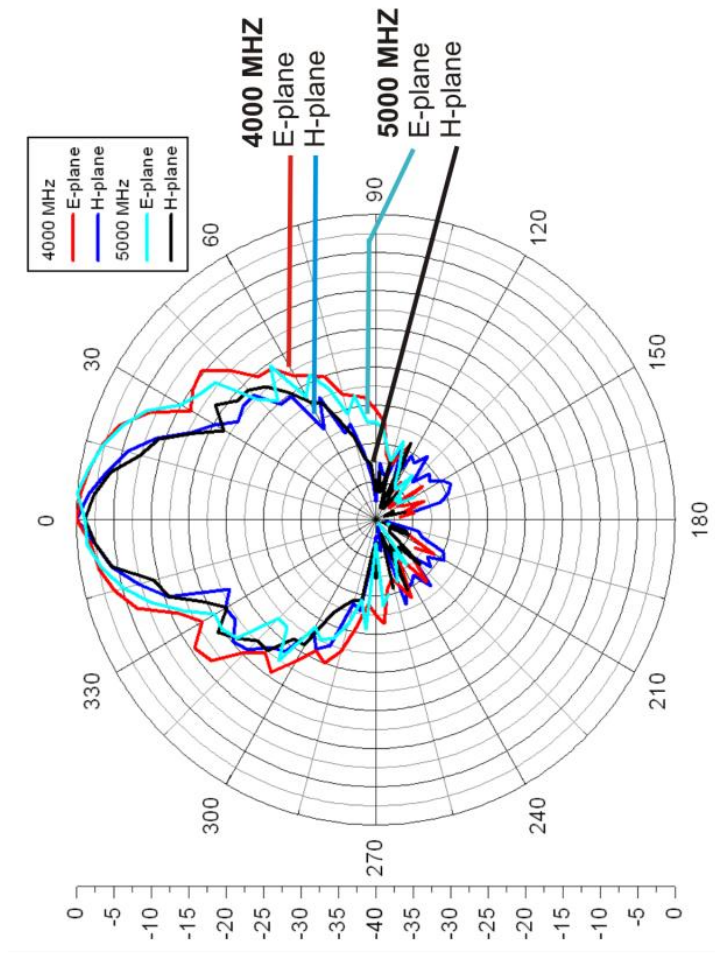

Model 3164-06 at 6000 MHz

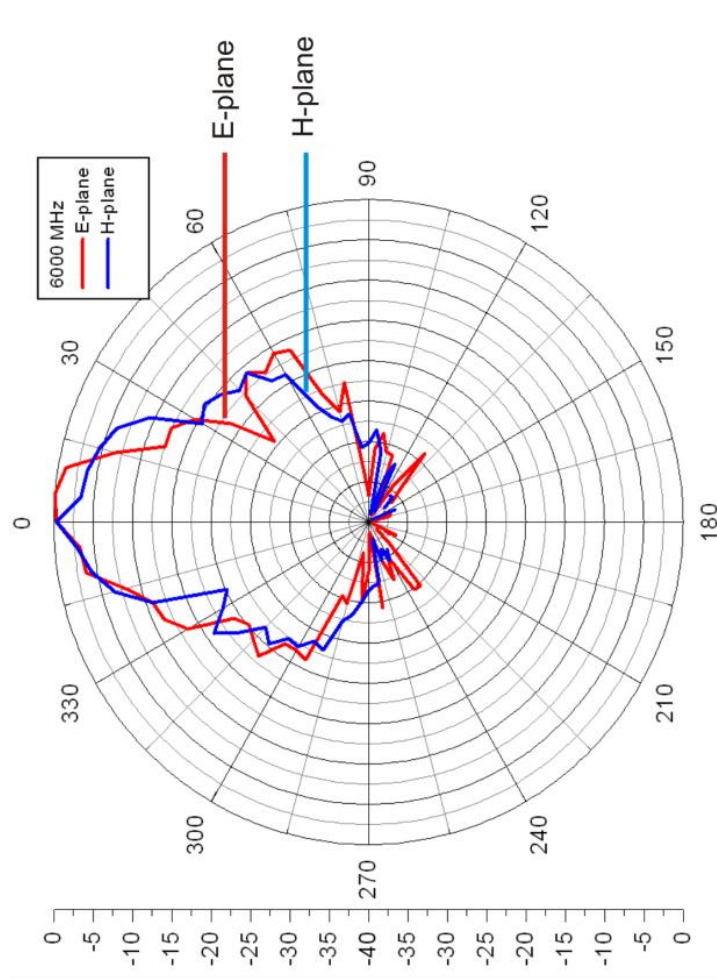

This page intentionally left blank.

10.0 Model 3164-08 Typical Data

Model 3164-08 Gain

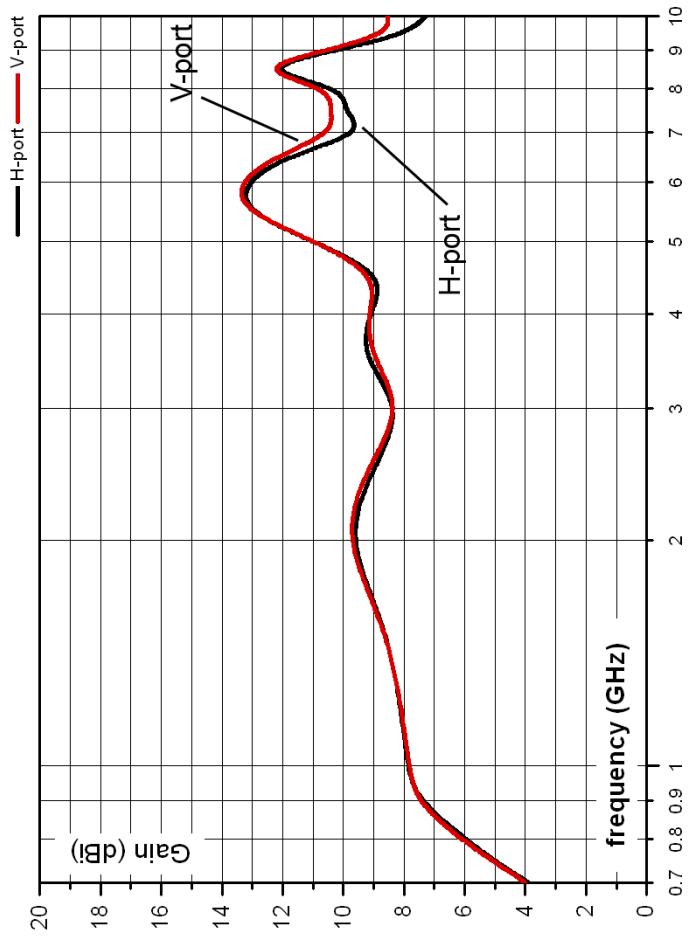

Model 3164-08 VSWR

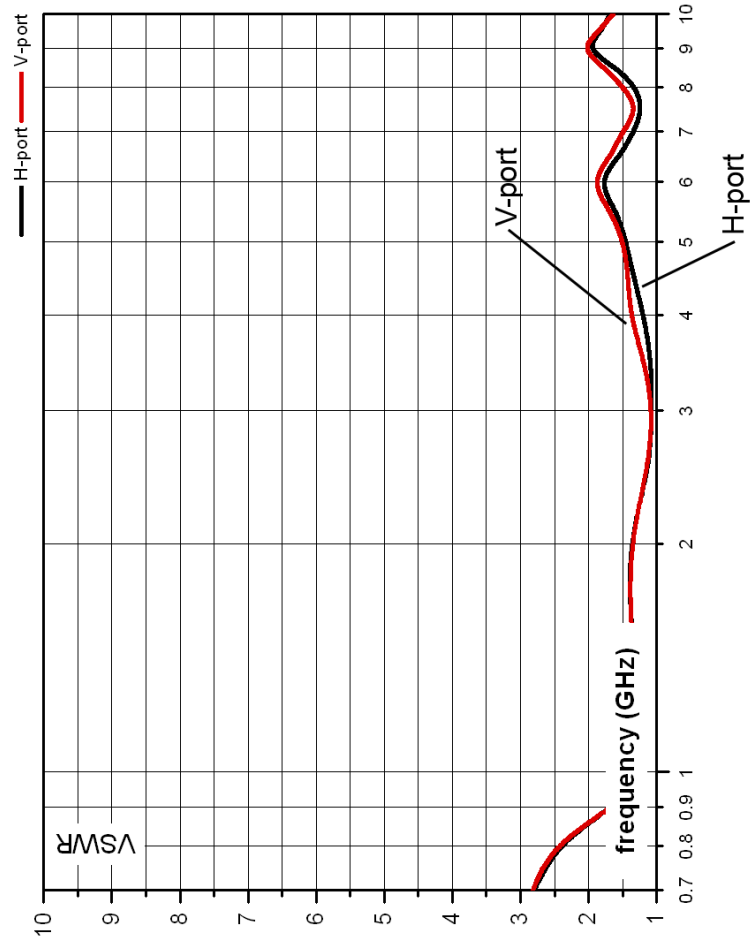

Model 3164-08 Cross-Port Isolation

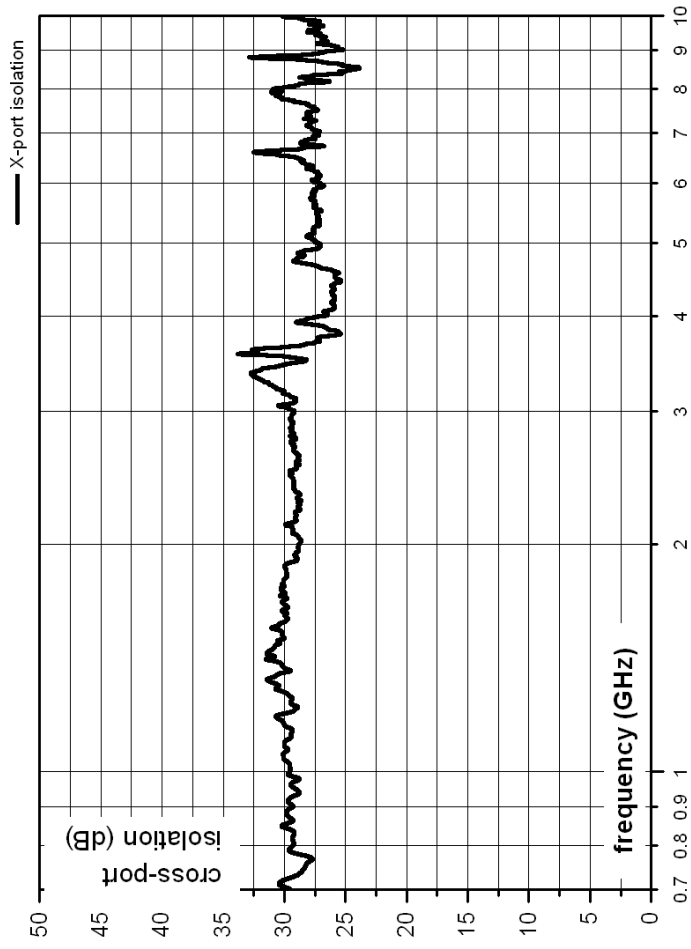

This page intentionally left blank.

11.0 Model 3164-08 Typical Radiation Patterns

Model 3164-08 at 700 MHz–800 MHz

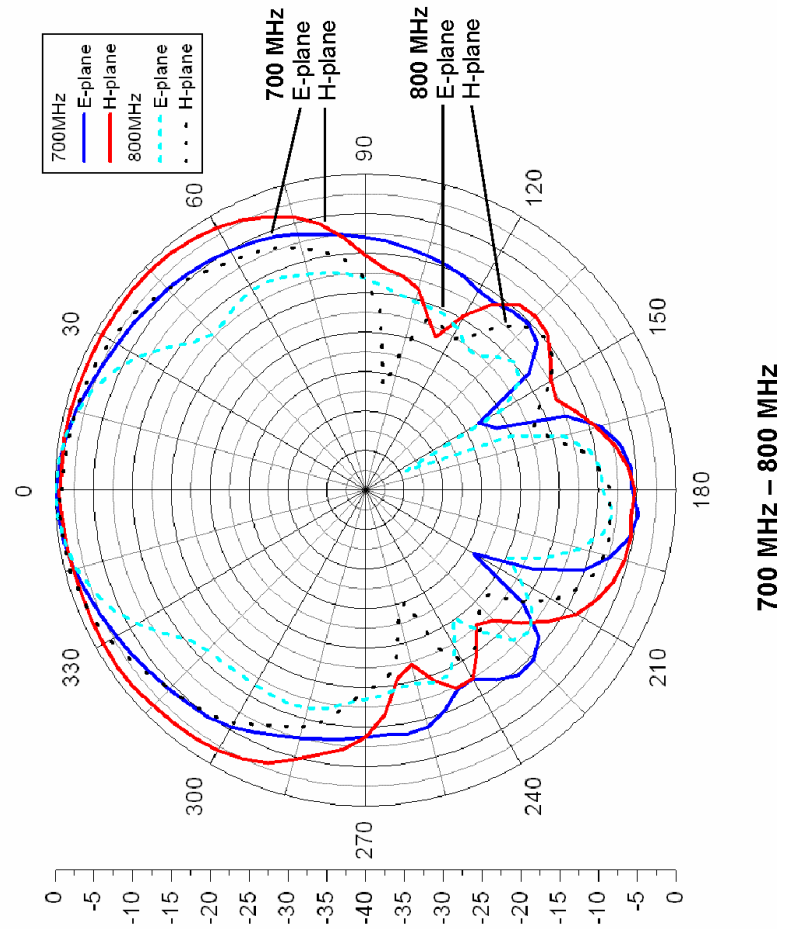

Model 3164-08 at 900 MHz–1000 MHz

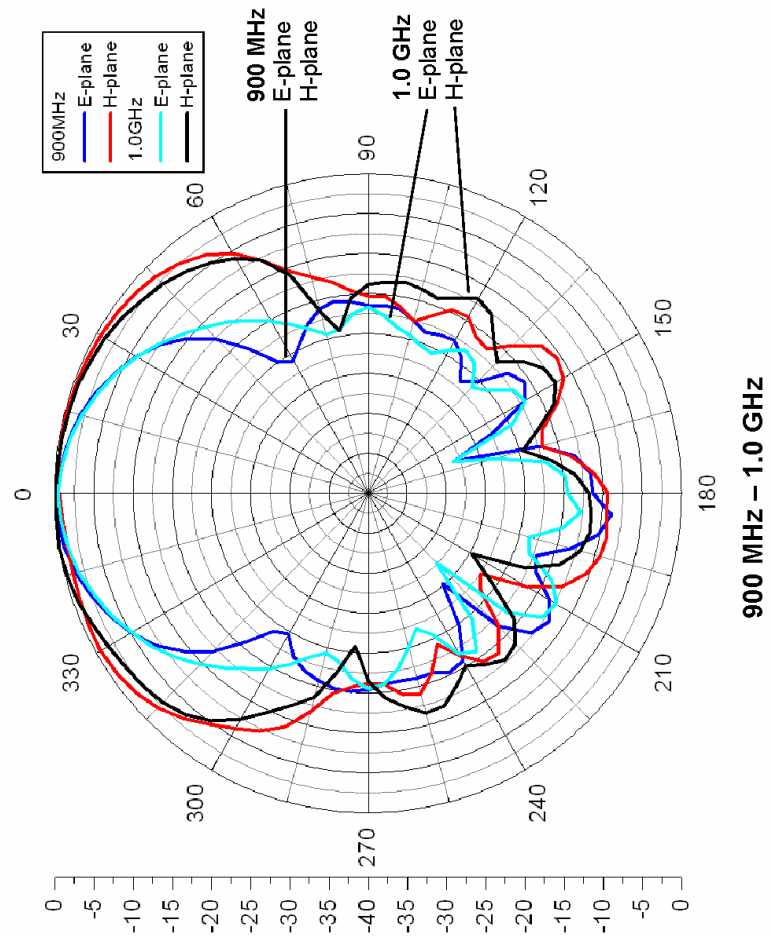

Model 3164-08 at 1.5 GHz–2.0 GHz

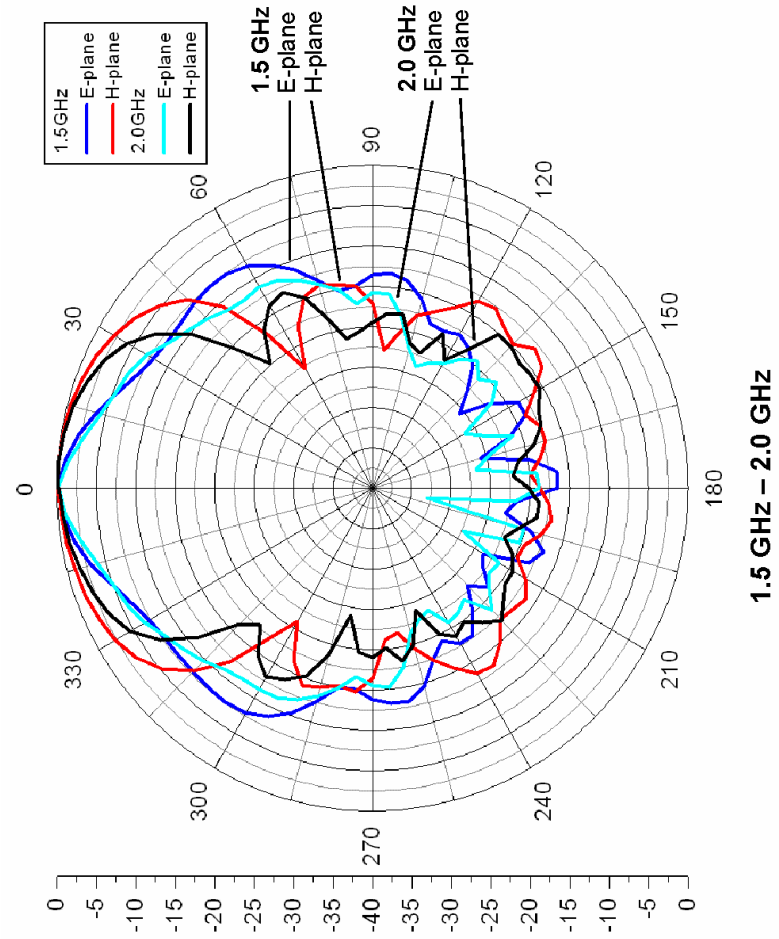

Model 3164-08 at 2.5 GHz–3.0 GHz

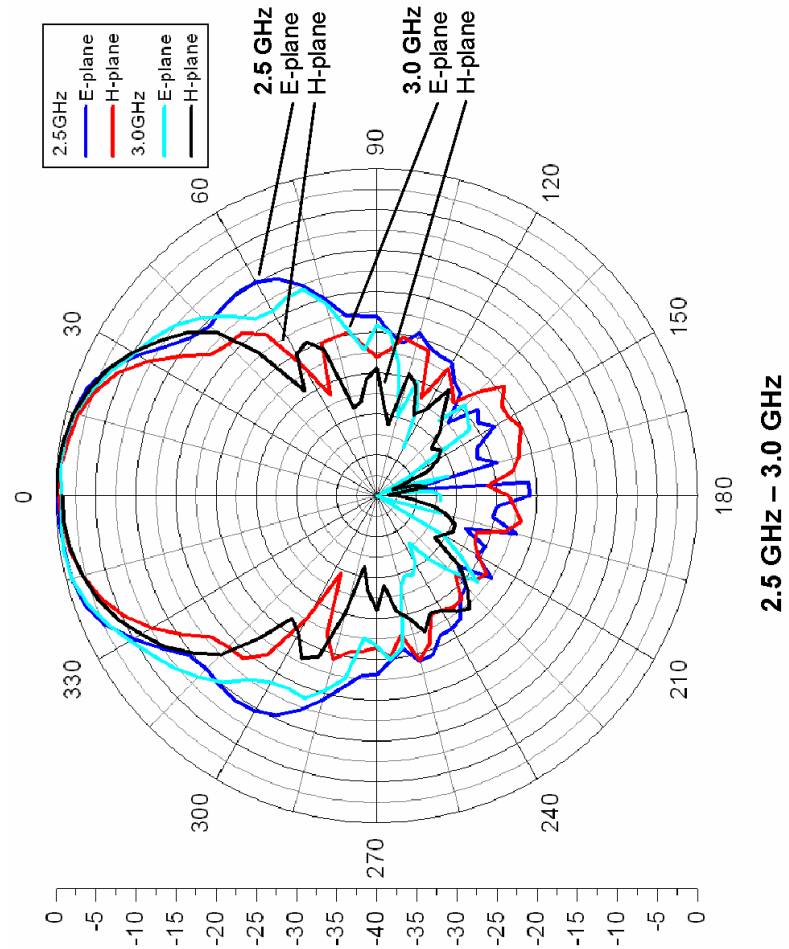

Model 3164-08 at 3.5 GHz–4.0 GHz

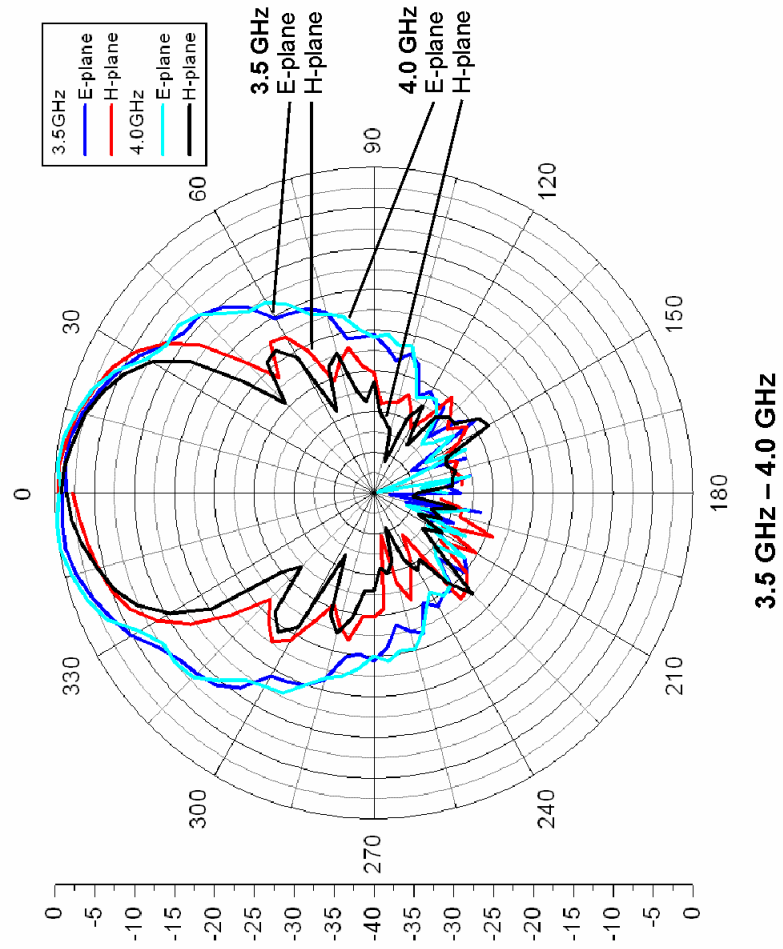

Model 3164-08 at 4.5 GHz–5.0 GHz

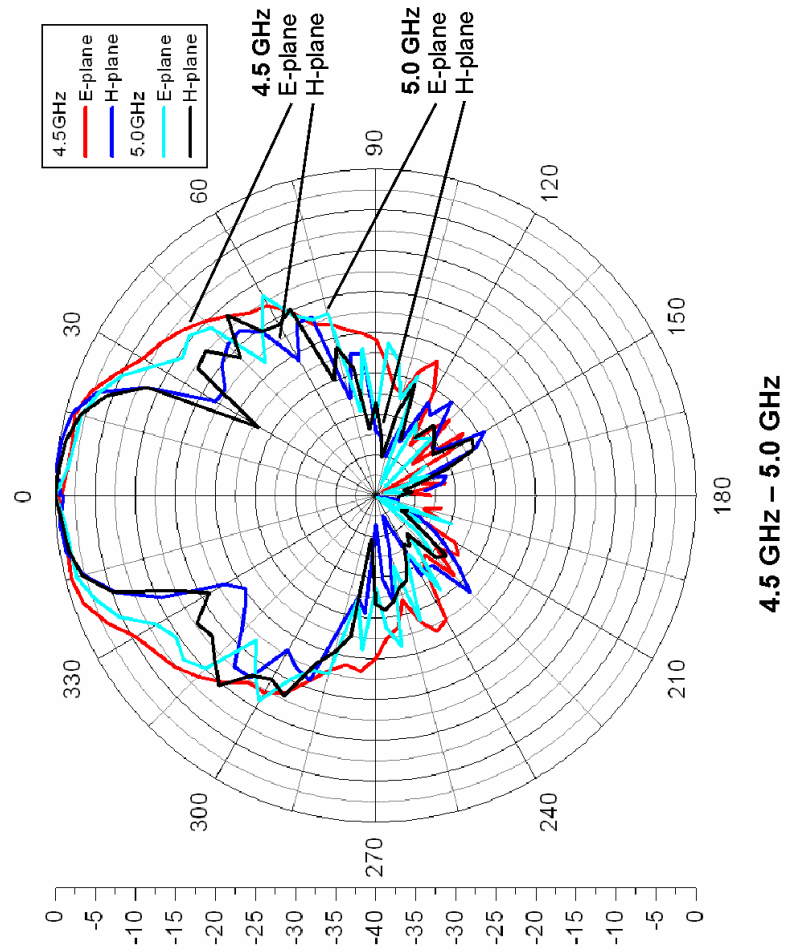

Model 3164-08 at 5.5 GHz–6.0 GHz

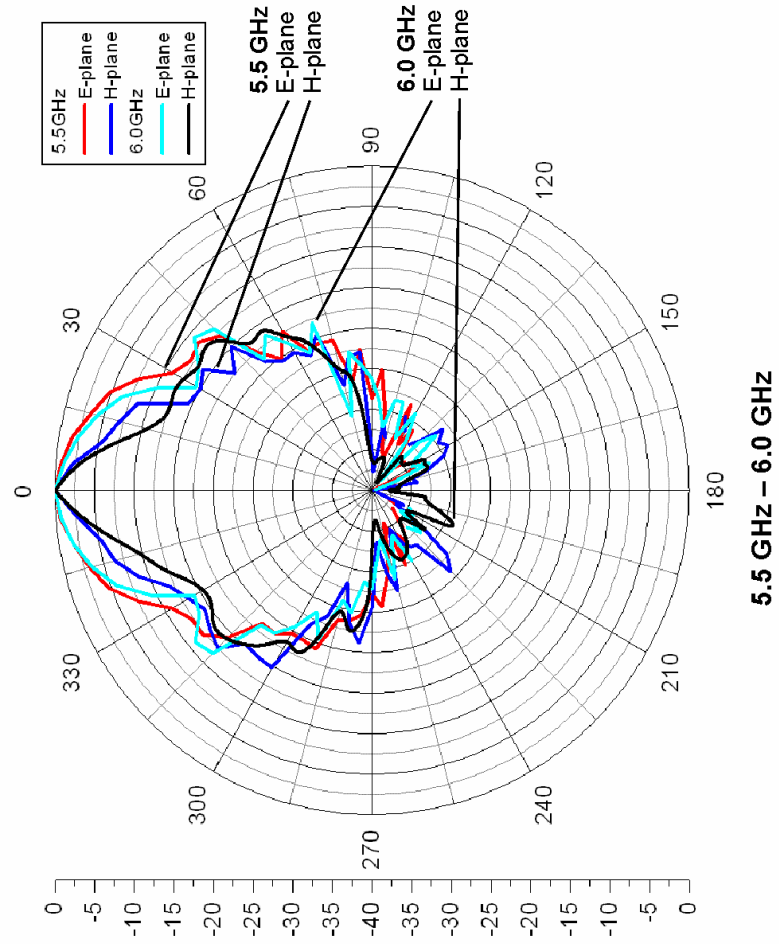

Model 3164-08 at 6.5 GHz–7.0 GHz

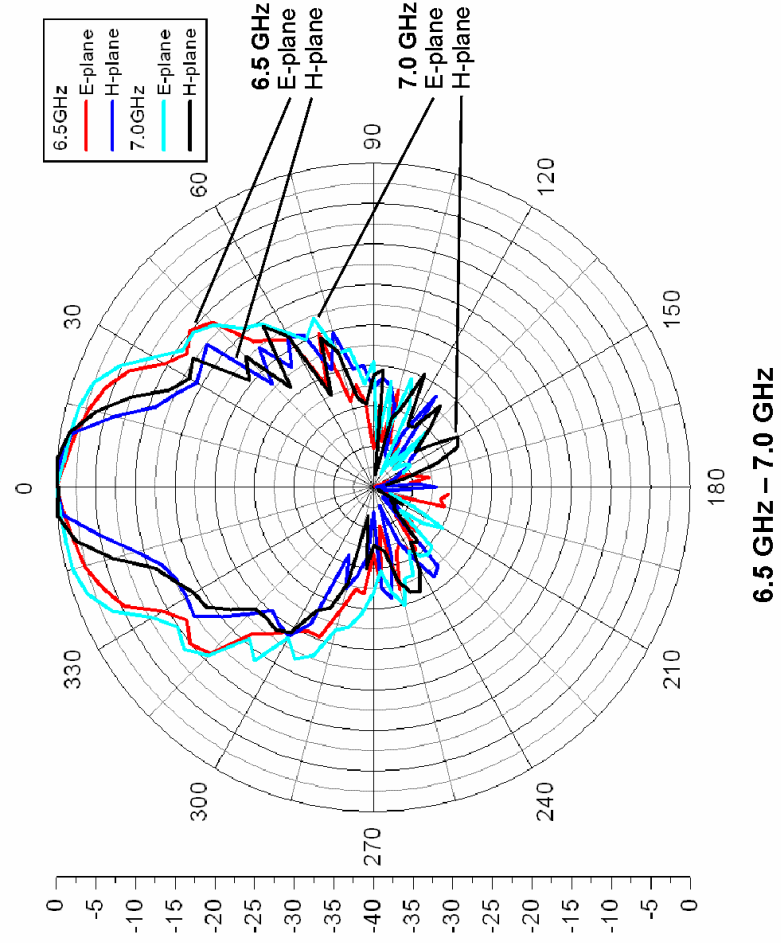

Model 3164-08 at 7.5 GHz–8.0 GHz

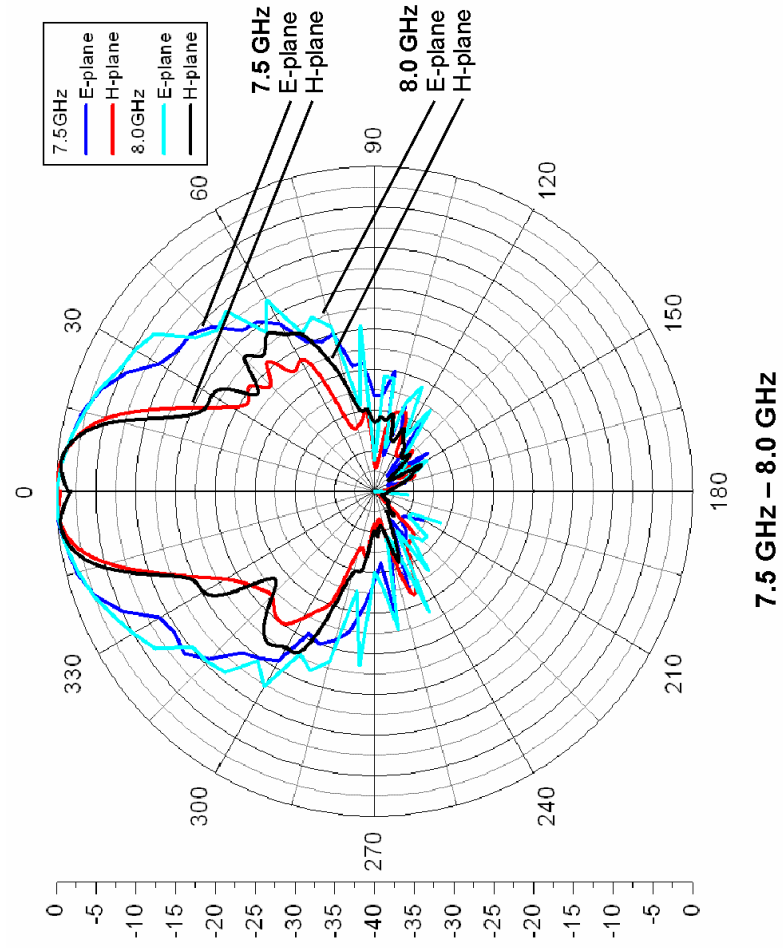

Model 3164-08 at 8.5 GHz–9.0 GHz

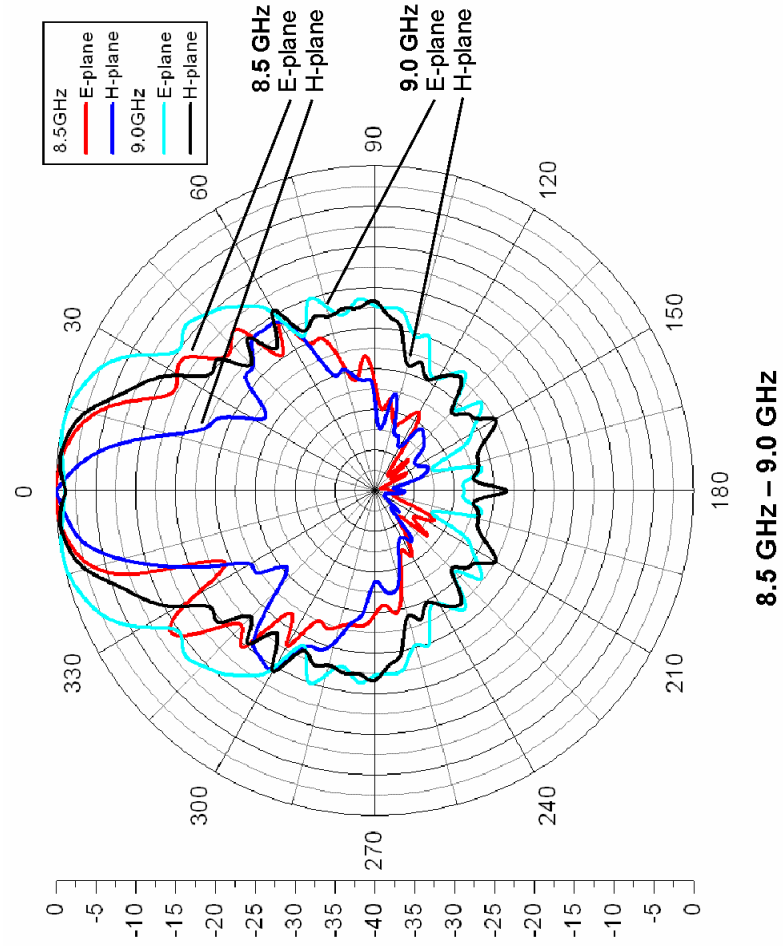

Model 3164-08 at 9.5 GHz–10.0 GHz

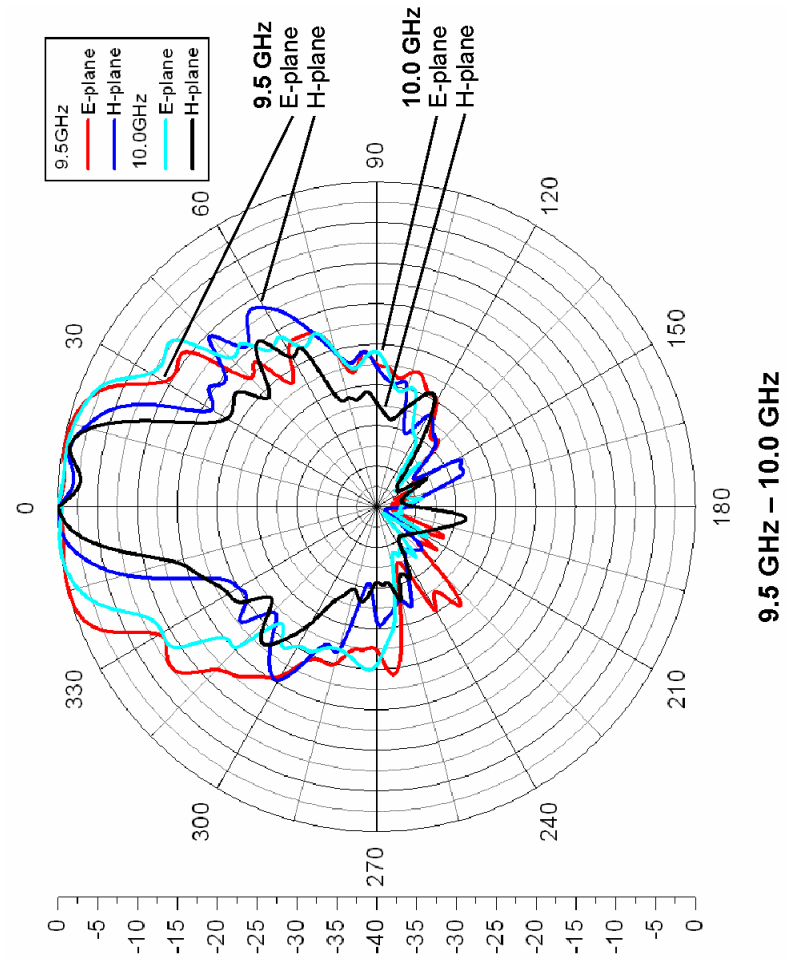

This page intentionally left blank.

12.0 Model 3164-10 Typical Data

Model 3164-10 Gain

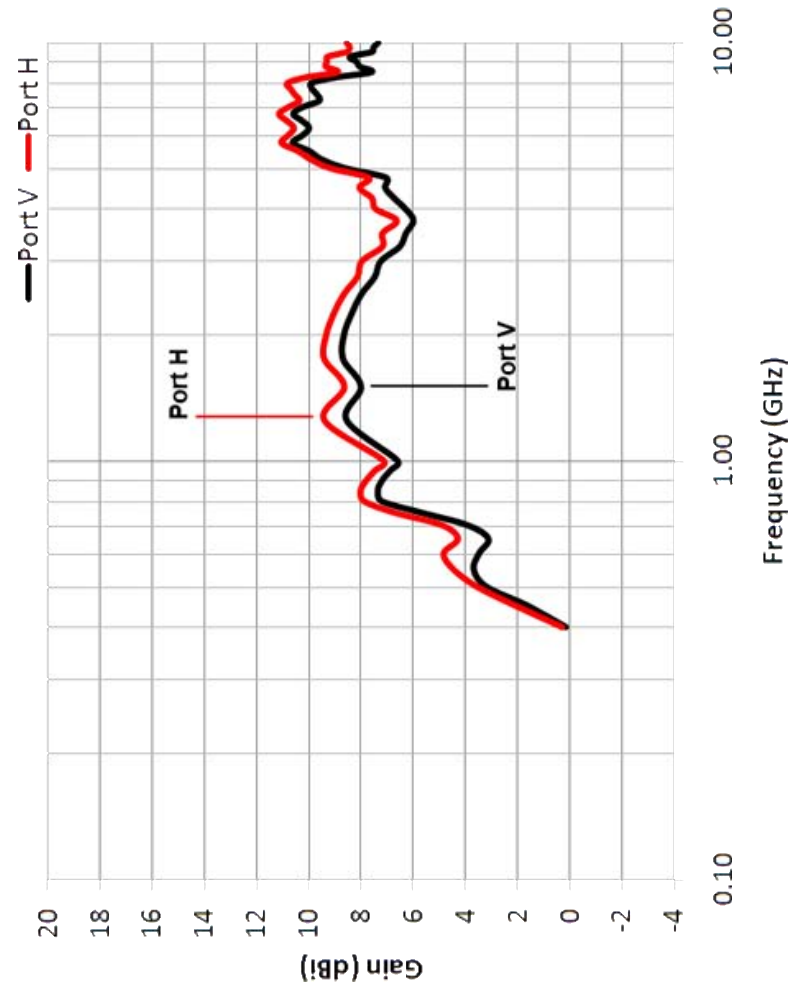

Model 3164-10 VSWR

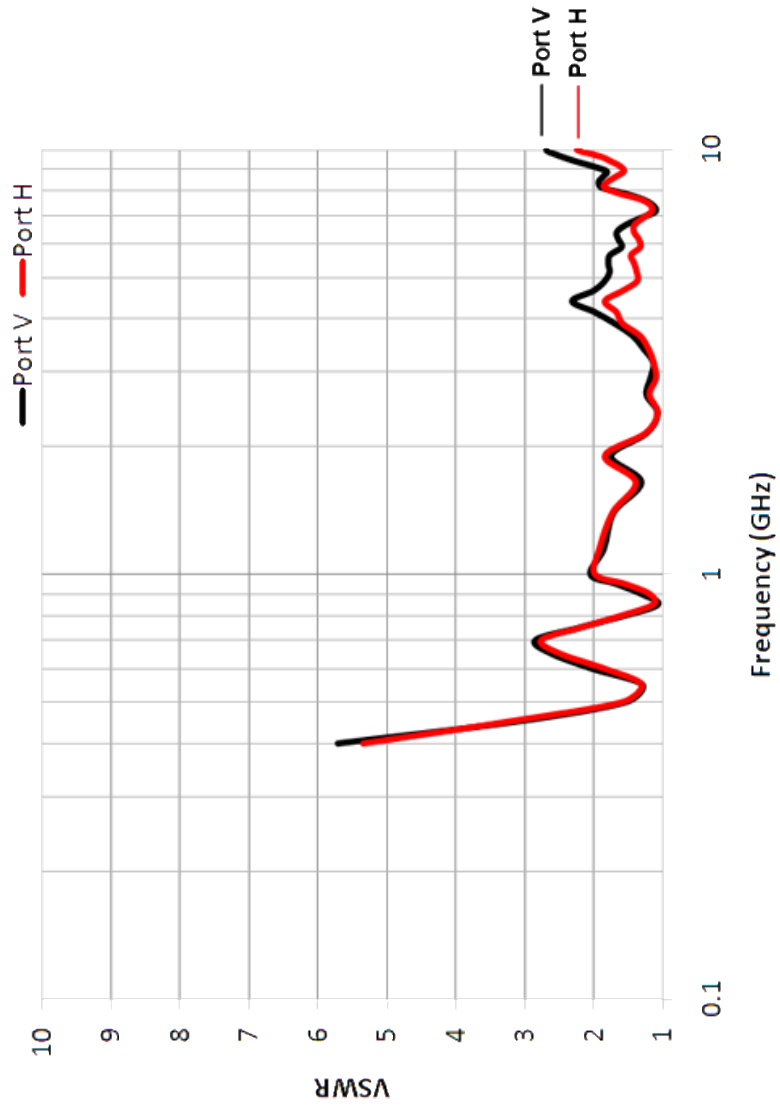

Model 3164-10 Cross-Port Isolation

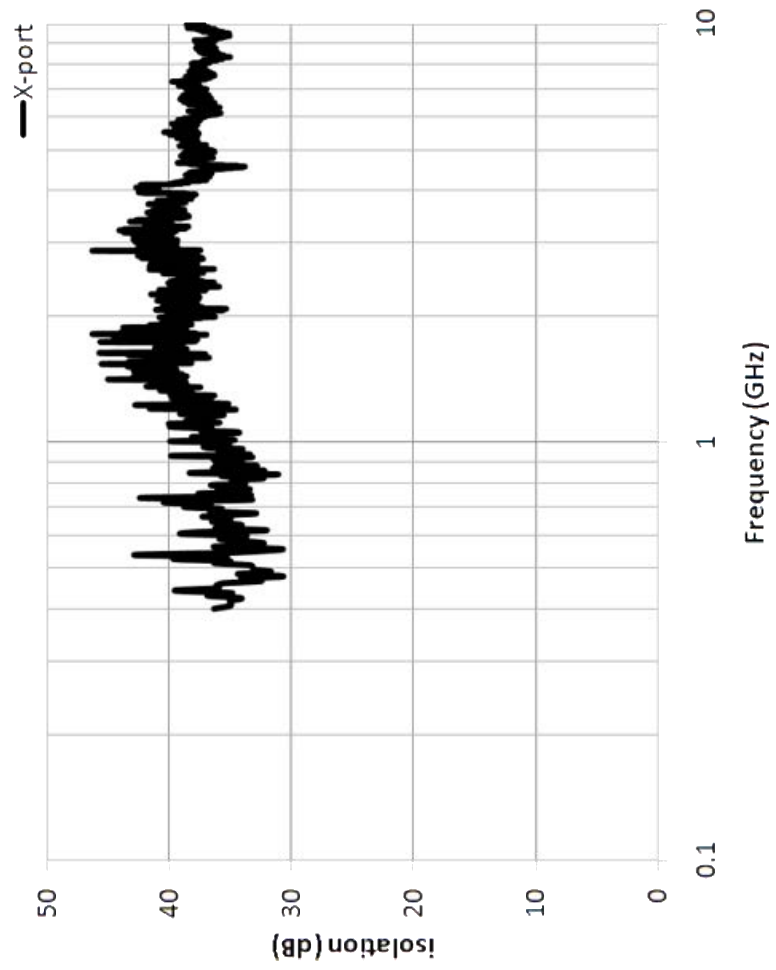

This page intentionally left blank.

13.0 Model 3164-10 Typical Radiation Patterns

Model 3164-10 E-Plane at 400 MHz–2000 MHz

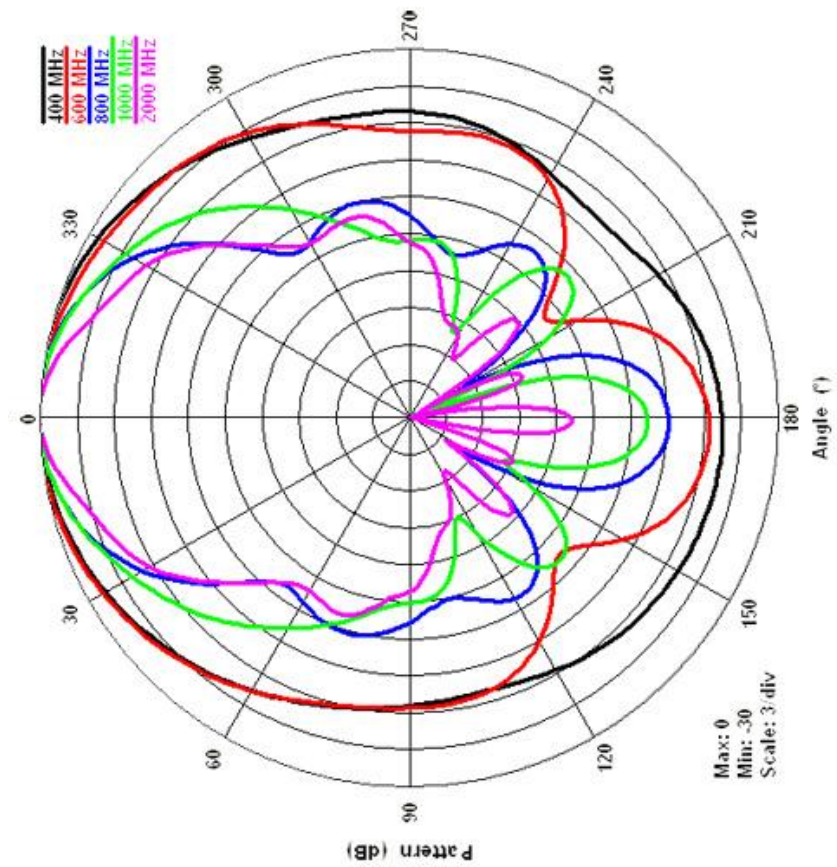

Model 3164-10 H-Plane at 400 MHz–2000 MHz

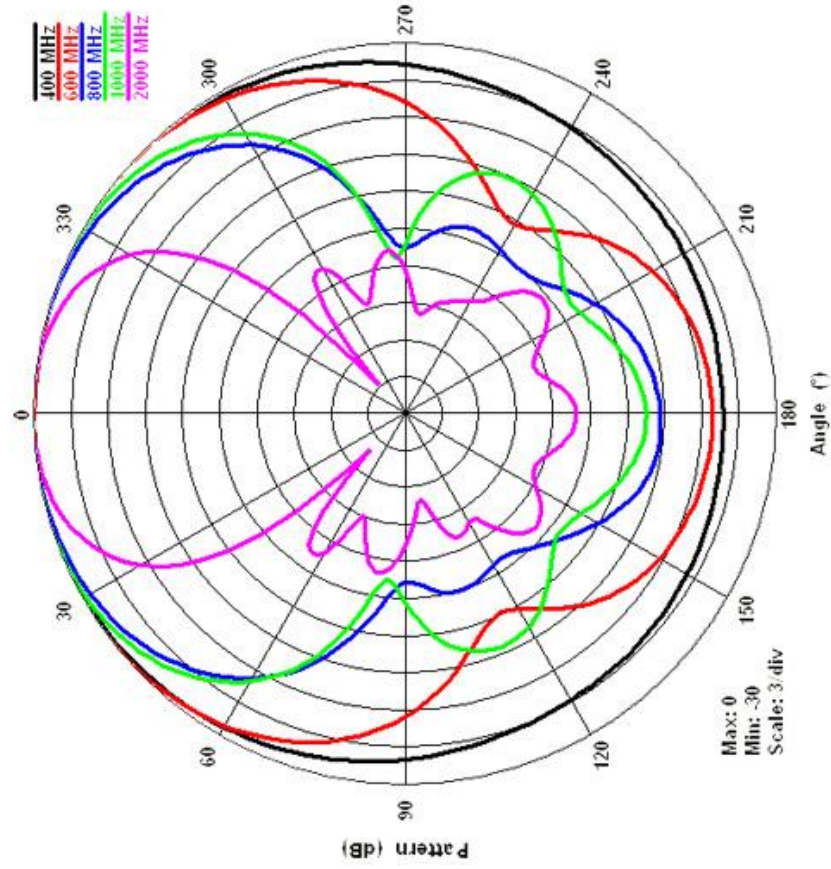

Model 3164-10 E-Plane at 2000 MHz–10000 MHz

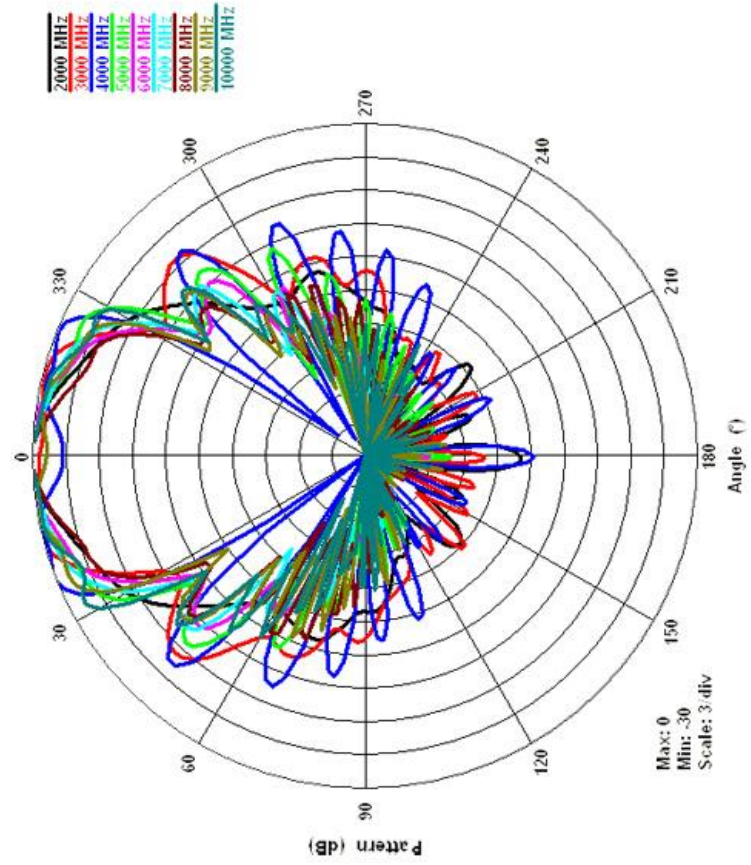

Model 3164-10 H-Plane at 2000 MHz–10000 MHz

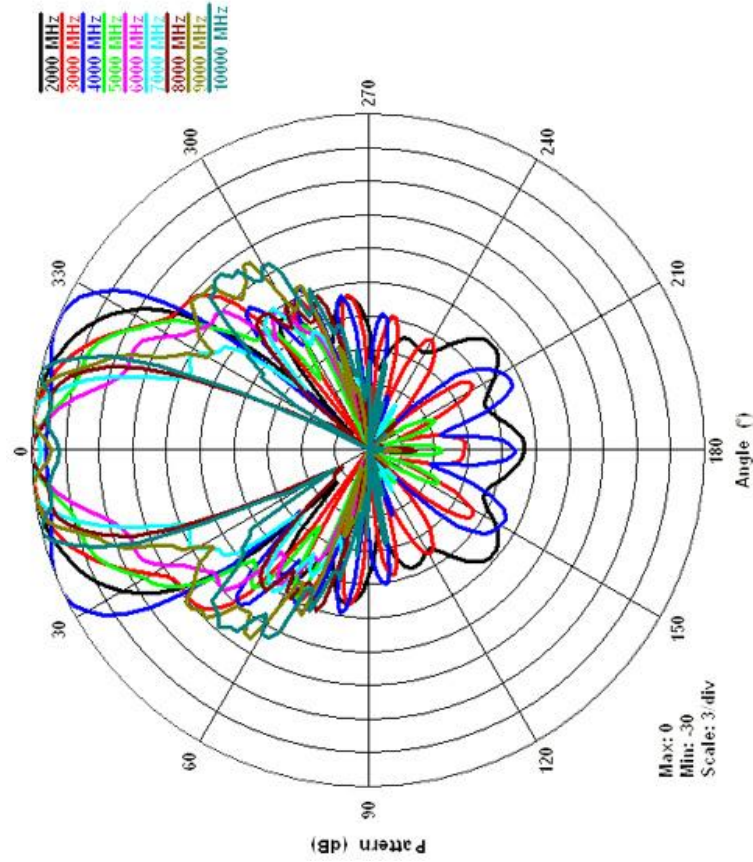

14.0 Model 3164-11 Typical Data

Model 3164-11 Gain and Antenna Factor

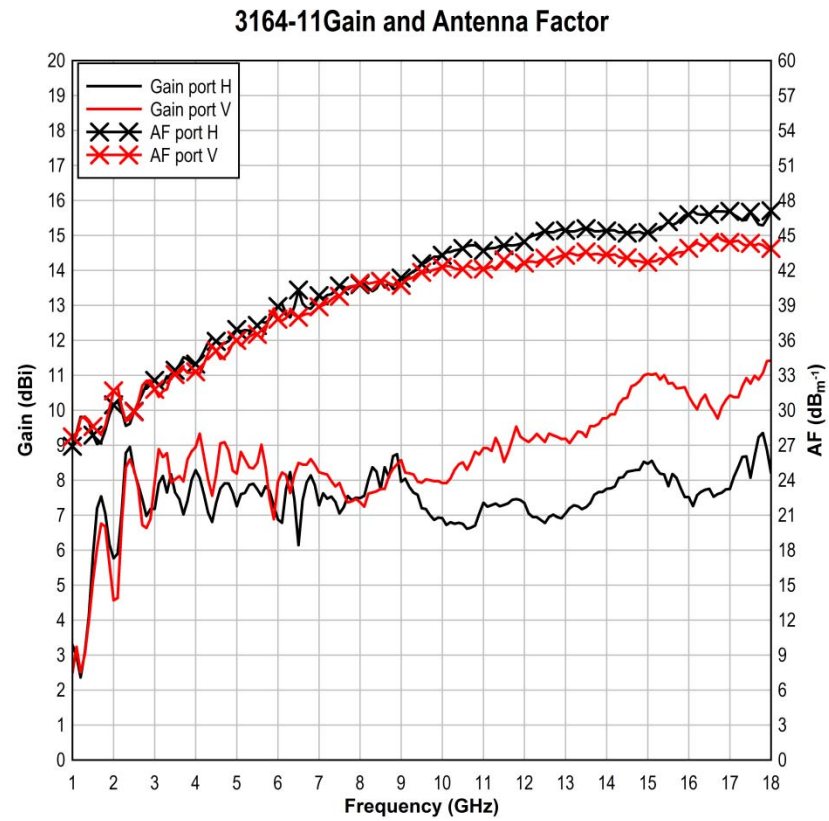

Model 3164-11 VSWR

3164-11VSWR

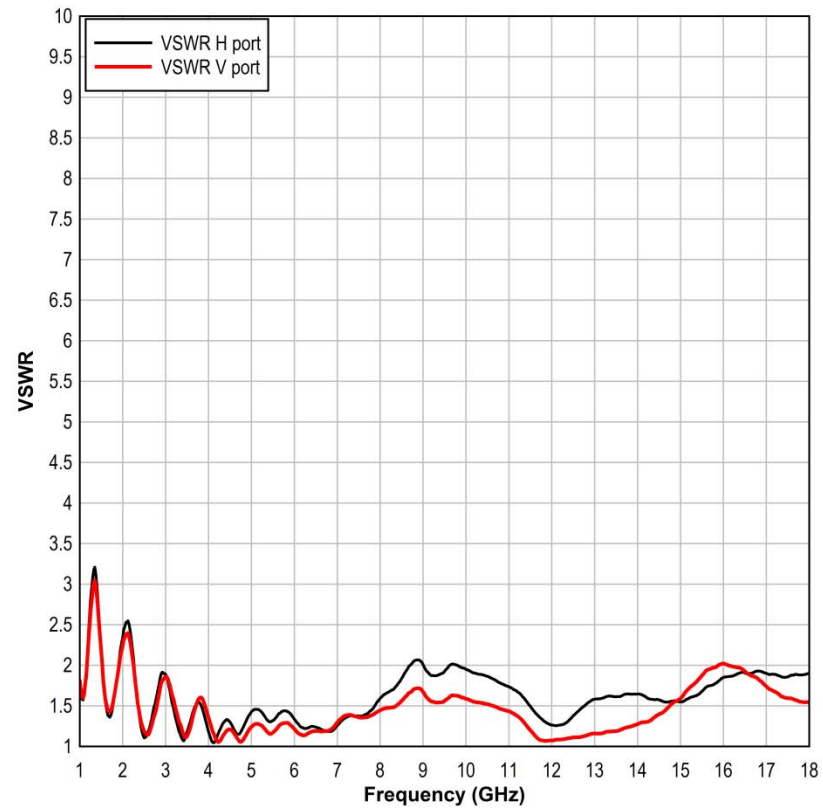

Model 3164-11 Cross-Port Isolation

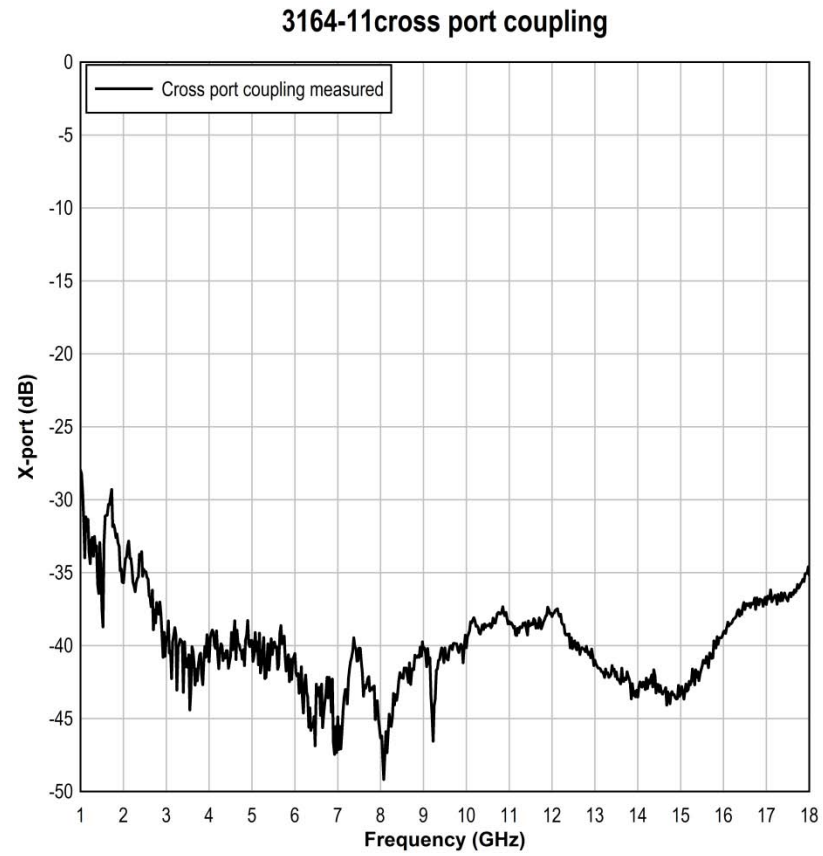

Model 3164-11 Half-Power Beamwidth

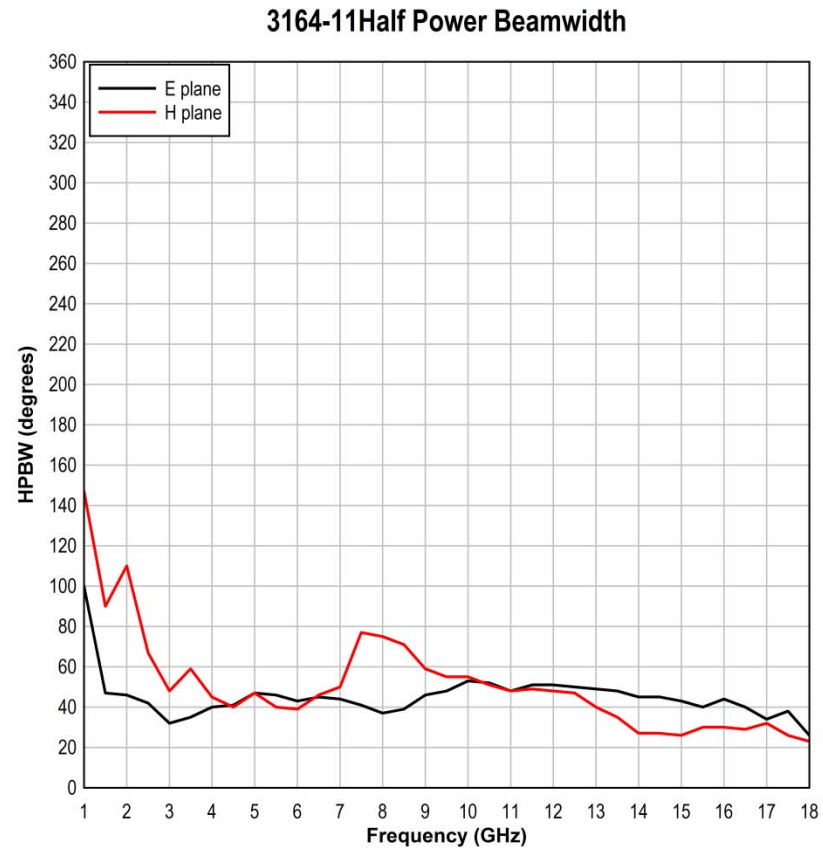

15.0 Model 3164-11 Typical Radiation Patterns

Model 3164-11 at 1 GHz–2 GHz

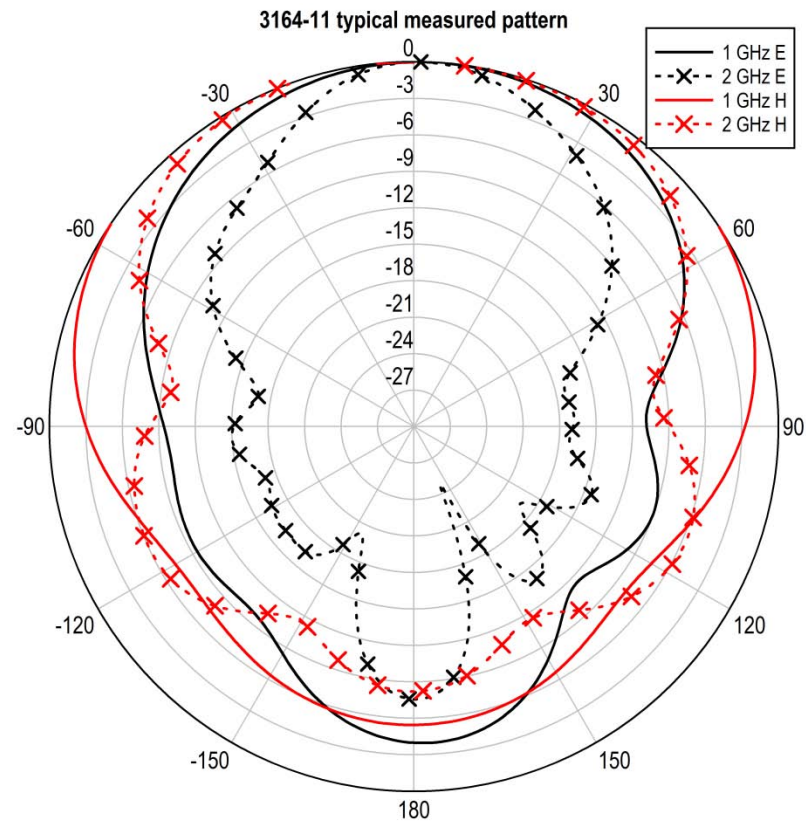

Model 3164-11 at 3 GHz–4 GHz

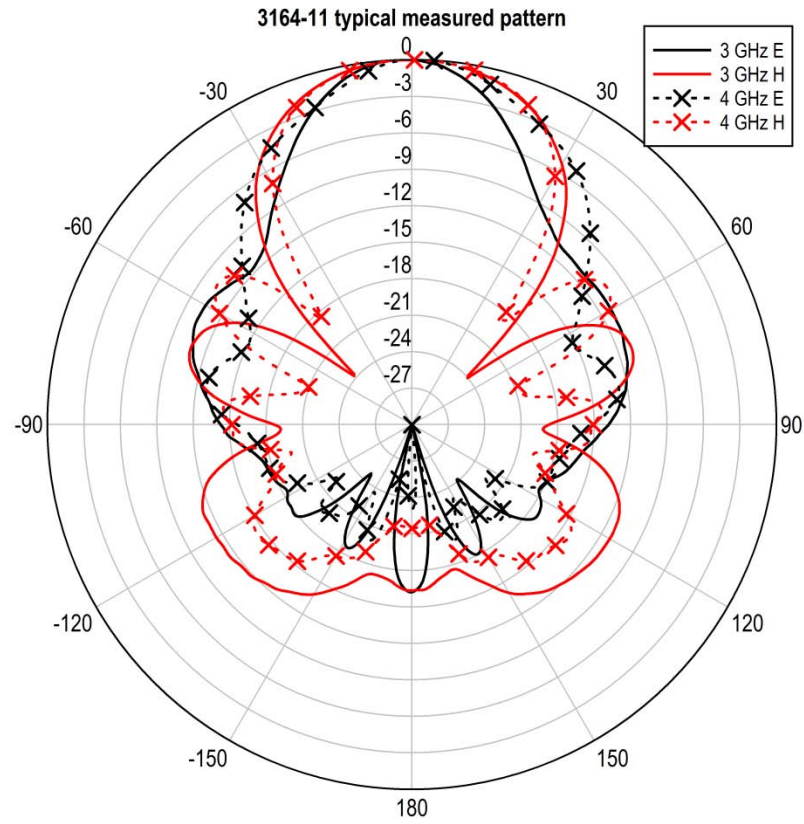

Model 3164-11 at 5 GHz–6 GHz

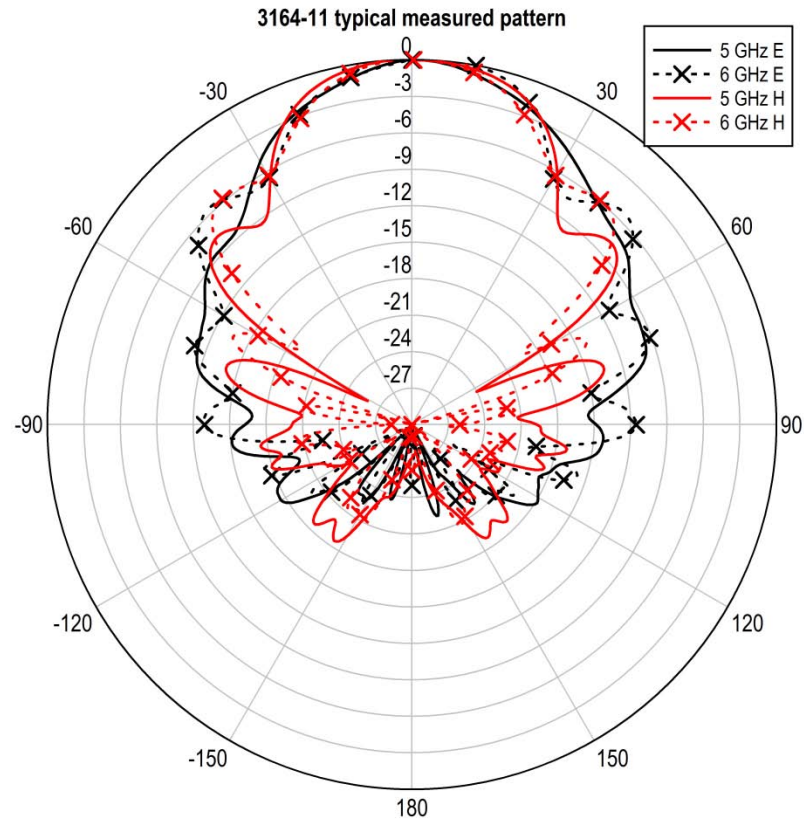

Model 3164-11 at 7 GHz–8 GHz

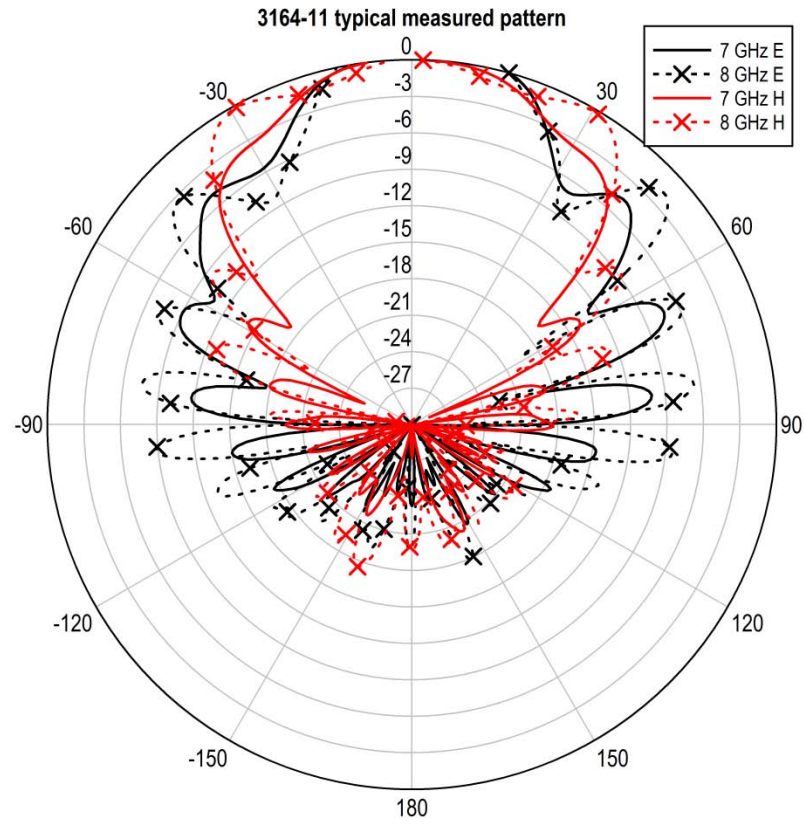

Model 3164-11 at 9 GHz–10 GHz

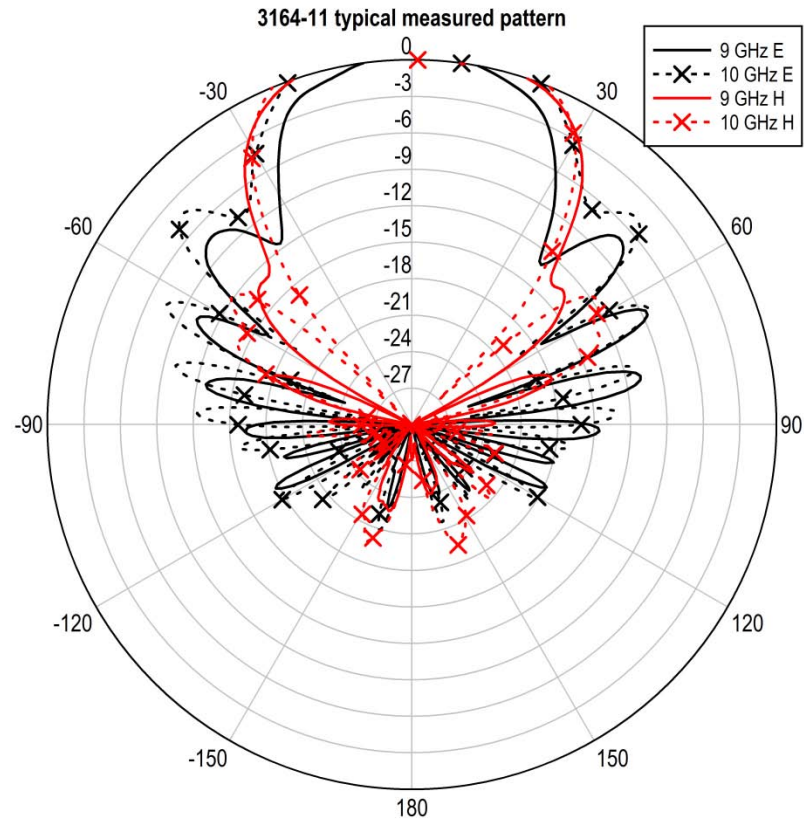

Model 3164-11 at 11 GHz–12 GHz

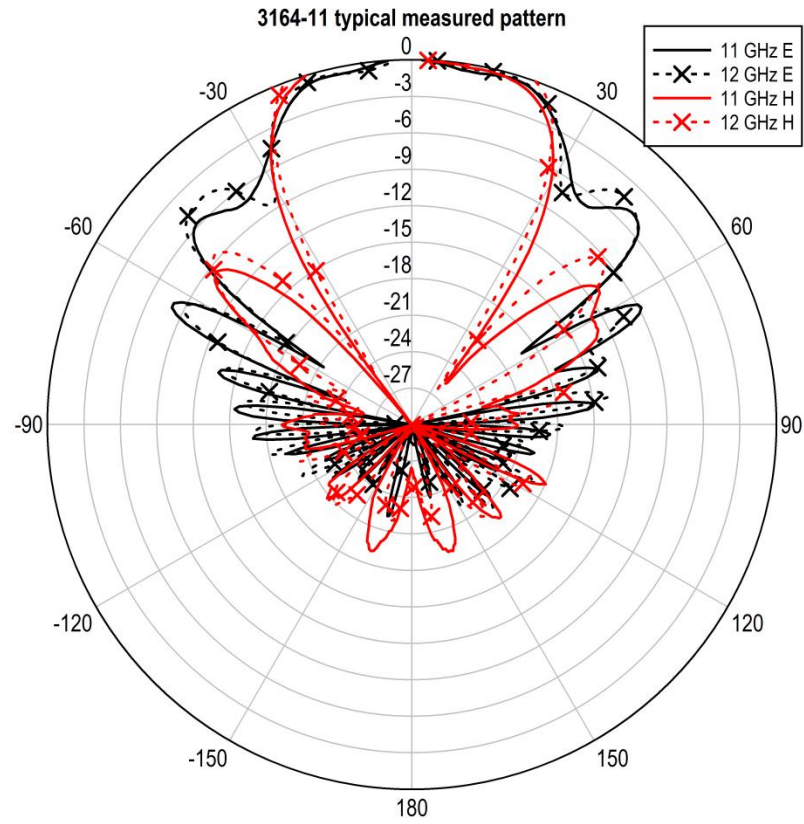

Model 3164-11 at 13 GHz–14 GHz

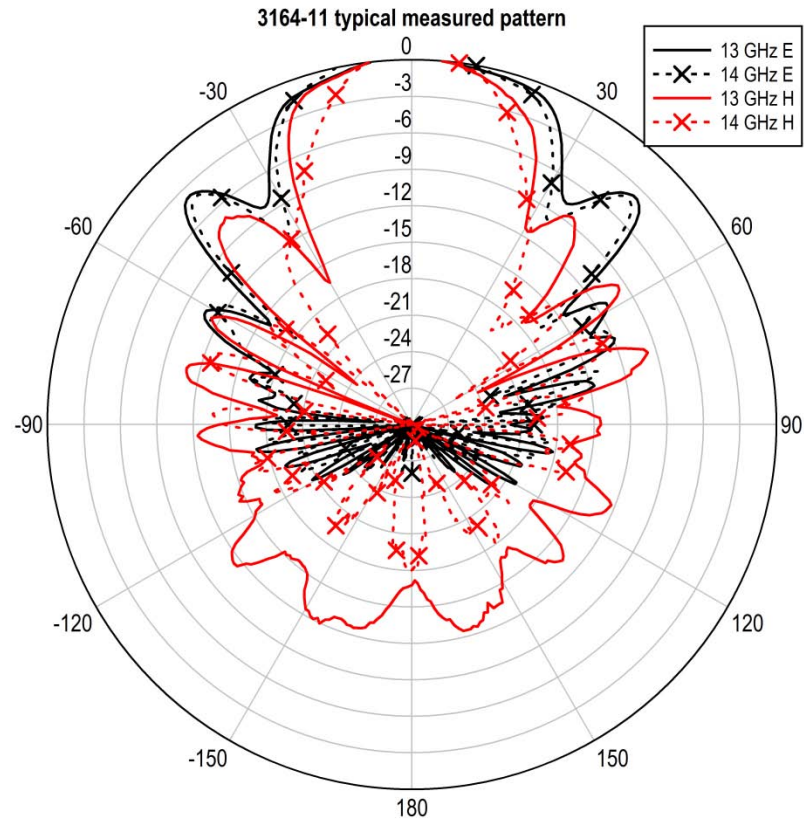

Model 3164-11 at 15 GHz–16 GHz

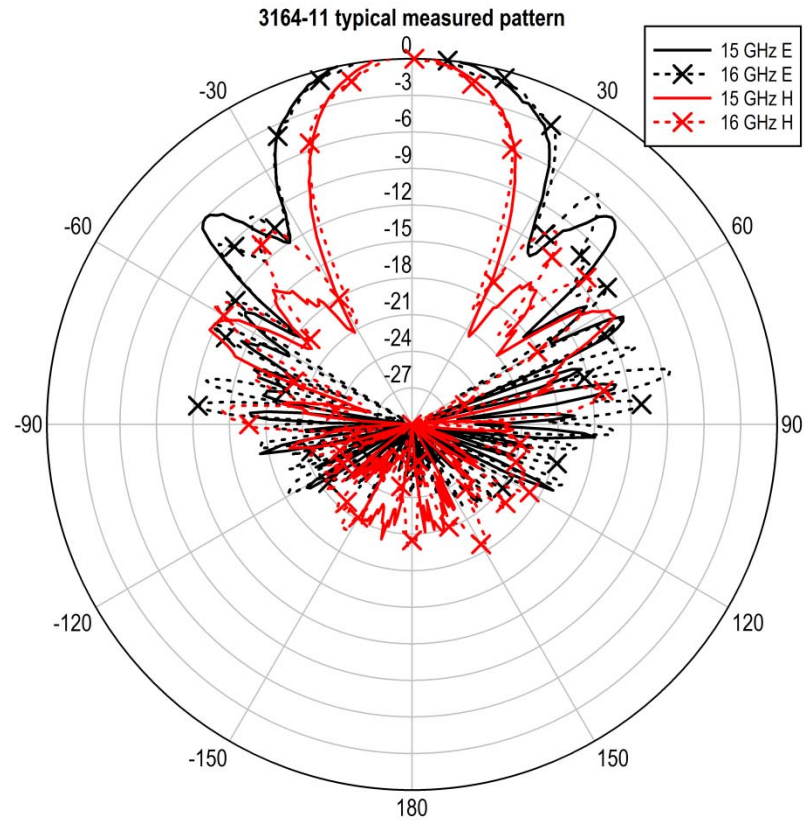

Model 3164-11 at 17 GHz–18 GHz

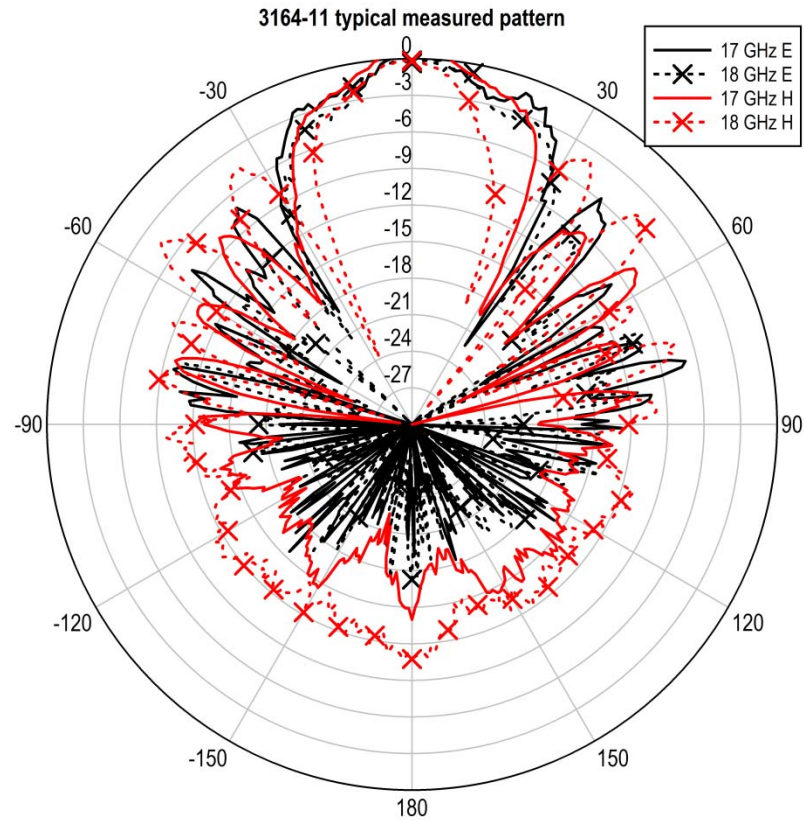

This page intentionally left blank.

Appendix A: Warranty



See the *Product Information Bulletin* included with your shipment for the complete ETS-Lindgren warranty for your Model 3164 Series.

DURATION OF WARRANTIES FOR MODEL 3164 SERIES

All product warranties, except the warranty of title, and all remedies for warranty failures are limited to two years.

Product Warranted	Duration of Warranty Period
Model 3164 Open Boundary Quad-Ridged Horns: <ul style="list-style-type: none">• 3164-05• 3164-06• 3164-08• 3164-10• 3164-11	2 Years