

# 6003A

Three Phase Power Calibrator

Operators Manual

## LIMITED WARRANTY AND LIMITATION OF LIABILITY

Each Fluke product is warranted to be free from defects in material and workmanship under normal use and service. The warranty period is one year and begins on the date of shipment. Parts, product repairs, and services are warranted for 90 days. This warranty extends only to the original buyer or end-user customer of a Fluke authorized reseller, and does not apply to fuses, disposable batteries, or to any product which, in Fluke's opinion, has been misused, altered, neglected, contaminated, or damaged by accident or abnormal conditions of operation or handling. Fluke warrants that software will operate substantially in accordance with its functional specifications for 90 days and that it has been properly recorded on non-defective media. Fluke does not warrant that software will be error free or operate without interruption.

Fluke authorized resellers shall extend this warranty on new and unused products to end-user customers only but have no authority to extend a greater or different warranty on behalf of Fluke. Warranty support is available only if product is purchased through a Fluke authorized sales outlet or Buyer has paid the applicable international price. Fluke reserves the right to invoice Buyer for importation costs of repair/replacement parts when product purchased in one country is submitted for repair in another country.

Fluke's warranty obligation is limited, at Fluke's option, to refund of the purchase price, free of charge repair, or replacement of a defective product which is returned to a Fluke authorized service center within the warranty period.

To obtain warranty service, contact your nearest Fluke authorized service center to obtain return authorization information, then send the product to that service center, with a description of the difficulty, postage and insurance prepaid (FOB Destination). Fluke assumes no risk for damage in transit. Following warranty repair, the product will be returned to Buyer, transportation prepaid (FOB Destination). If Fluke determines that failure was caused by neglect, misuse, contamination, alteration, accident, or abnormal condition of operation or handling, including overvoltage failures caused by use outside the product's specified rating, or normal wear and tear of mechanical components, Fluke will provide an estimate of repair costs and obtain authorization before commencing the work. Following repair, the product will be returned to the Buyer transportation prepaid and the Buyer will be billed for the repair and return transportation charges (FOB Shipping Point).

THIS WARRANTY IS BUYER'S SOLE AND EXCLUSIVE REMEDY AND IS IN LIEU OF ALL OTHER WARRANTIES, EXPRESS OR IMPLIED, INCLUDING BUT NOT LIMITED TO ANY IMPLIED WARRANTY OF MERCHANTABILITY OR FITNESS FOR A PARTICULAR PURPOSE. FLUKE SHALL NOT BE LIABLE FOR ANY SPECIAL, INDIRECT, INCIDENTAL, OR CONSEQUENTIAL DAMAGES OR LOSSES, INCLUDING LOSS OF DATA, ARISING FROM ANY CAUSE OR THEORY.

Since some countries or states do not allow limitation of the term of an implied warranty, or exclusion or limitation of incidental or consequential damages, the limitations and exclusions of this warranty may not apply to every buyer. If any provision of this Warranty is held invalid or unenforceable by a court or other decision-maker of competent jurisdiction, such holding will not affect the validity or enforceability of any other provision.

Fluke Corporation  
P.O. Box 9090  
Everett, WA 98206-9090  
U.S.A.

Fluke Europe B.V.  
P.O. Box 1186  
5602 BD Eindhoven  
The Netherlands

# Table of Contents

Chapter	Title	Page
<b>1</b>	<b>Introduction .....</b>	<b>1-1</b>
	Introduction.....	1-1
	Contact Fluke Calibration .....	1-1
	Safety Information .....	1-2
	Symbols.....	1-4
	Protective Earth (Grounding).....	1-4
	Features .....	1-5
	Specifications .....	1-5
	Input Power .....	1-5
	Dimensions.....	1-5
	Environment .....	1-6
	Safety .....	1-6
	EMC.....	1-6
	General Electrical .....	1-6
	Electrical Specifications.....	1-6
	Temperature Coefficient.....	1-6
	Voltage .....	1-6
	Voltage Channel Maximum Capacitive Loading for	
	Output Stability .....	1-6
	Voltage Range Limits and Burden.....	1-7
	Voltage Sine Amplitude .....	1-7
	Voltage DC .....	1-8
	Voltage Distortion .....	1-8
	Current.....	1-8
	Current Range Limits and Compliance.....	1-8
	Current Sine Amplitude .....	1-9
	Current DC .....	1-9
	Current Distortion .....	1-9
	Current Output Isolation (high or low terminal).....	1-10
	Voltage from the Current Terminals (DC and Sine Wave Only) .....	1-10
	Range Limits and Impedances .....	1-10
	Voltage from Current Terminals .....	1-10
	Voltage from Current Terminals, Distortion .....	1-10
	Phase and Power Factor (Sine Wave Outputs).....	1-10

	Current to Voltage Phase .....	1-10
	Voltage to Voltage Phase .....	1-11
	Power .....	1-11
	Sinusoidal Power Specification at 40 Hz to 70 Hz, Power Factor 1.0 (%).....	1-11
	Sinusoidal Power Specification at 40 Hz to 70 Hz, Power Factor 0.8 (%).....	1-11
	Sinusoidal Power Specification at 40 Hz to 70 Hz, Power Factor 0.5 (%).....	1-12
	DC Power Specification (%) .....	1-12
	Multimeter.....	1-12
	IN2 Input.....	1-12
	Energy (6003A/E Energy Option).....	1-12
	Pulse Inputs (IN1).....	1-12
	Energy Pulse Output .....	1-12
	Energy .....	1-12
	Test Duration .....	1-12
	Power Quality (6003A/PQ Power Quality Option) .....	1-13
	Voltage and Current Sinusoidal and Rectangular Modulation Flicker Specification.....	1-13
	Harmonics and Interharmonic .....	1-13
	Dip/Swell.....	1-14
<b>2</b>	<b>Installation .....</b>	<b>2-1</b>
	Introduction.....	2-1
	Unpack and Inspection .....	2-1
	Reship the Instrument .....	2-1
	Placement .....	2-2
	Cooling Considerations .....	2-2
	Line Voltage .....	2-2
	Line Voltage Fuse .....	2-2
	Connect to Line Power .....	2-3
	Preparation for Operation.....	2-3
	Inspect Package Contents, Installation Location.....	2-3
	Installation Power and Location.....	2-4
	Optional 90 A High Current Adapter.....	2-4
	Power-on .....	2-5
	Warmup.....	2-5
<b>3</b>	<b>Features and Basic Operation.....</b>	<b>3-1</b>
	Introduction.....	3-1
	Front-Panel Features .....	3-1
	The Display.....	3-7
	Rear Panel.....	3-9
	Basic Operation.....	3-10
	Select a Function.....	3-10
	Setting the Value of the Output Signal .....	3-11
	Edit Mode .....	3-11
	Entry of the Value with the Numeric Keyboard .....	3-12
	Entry of the Value with the Cursor Buttons.....	3-12
	Entry of the Value with the Rotary Knob.....	3-13
	Connection/Disconnection of Output Terminals .....	3-13
	Control Sequence when the Output Voltage is >100 V is Selected.....	3-14

	Multimeter.....	3-14
<b>4</b>	<b>Front-Panel Operation.....</b>	<b>4-1</b>
	Introduction.....	4-1
	Power Up.....	4-1
	Warmup.....	4-1
	Set the Language on the Display .....	4-2
	Function Selection.....	4-2
	Setup Menu (Main Menu).....	4-3
	General Menu.....	4-4
	Interface Menu.....	4-5
	Calibrator Menu.....	4-5
	Meter Menu .....	4-9
	Calibration Menu .....	4-10
	Activate the Output Terminals .....	4-10
	Control Sequence when Output Voltage >100 V.....	4-11
	Set the Output .....	4-12
	Edit mode .....	4-12
	Enter a Value with the Numeric Keypad.....	4-12
	Enter a Value with the Cursor Buttons .....	4-13
	Enter a Value with the Rotary Knob .....	4-13
	Generating Electric Power.....	4-13
	Control in the Power Mode.....	4-14
	Power Factor Polarity (Lead/Lag Softkey).....	4-15
	Power Units (Units Softkey).....	4-15
	Power Modes (Mode Softkey) .....	4-16
	Setting the Power in Modes Pdc Basic and Pac Basic.....	4-17
	Set the Power in Pdc High I and Pac High I Modes .....	4-19
	Set the Power in Pdc Extended and Pac Extended Modes.....	4-19
	Set the Amplitude of Voltage or Current.....	4-20
	Set the Phase (AC Power Only).....	4-21
	Set the Frequency (AC Power Only) .....	4-22
	Power Quality Modes (Available with 6003A/PQ Power Quality Option only) .....	4-22
	Set the Power in P Harmonic Mode .....	4-22
	Set the Amplitude of Voltage or Current.....	4-23
	Set the Phase.....	4-23
	Set the Amplitude and Phase of Harmonic Components .....	4-23
	Set the Modulation.....	4-24
	Set the Power in P Interharmonic Mode.....	4-25
	Set the Amplitude (RMS value) of Voltage (Current).....	4-25
	Set the Phase .....	4-25
	Set the Amplitude (RMS Value) of the Interharmonic Component .....	4-26
	Set the Power in P Dip/Swell Mode.....	4-26
	Set the Amplitude (RMS value) of Voltage or Current.....	4-27
	Set the Phase.....	4-27
	Set the Amplitude (RMS Value) of Dip/Swell.....	4-28
	Set Dip/Swell Time Periods .....	4-28
	Generate Electric Energy (Available with 6003A/E Energy Option installed) .....	4-28
	Energy Pulse Output .....	4-28
	Control in the Energy Mode.....	4-29
	Power Factor Polarity (Lead/Lag Softkey).....	4-30
	Power Units (Units Softkey).....	4-30
	Methods of Energy Counting (Control) .....	4-31

Packet (Time Counting) .....	4-31
Counter (Pulse counting) .....	4-31
Timer .....	4-31
Free Run (Frequency Measuring) .....	4-31
Energy Modes (Mode Softkey) .....	4-32
Set the Energy in modes Edc Basic and Eac Basic .....	4-32
Set the Voltage .....	4-32
Set the Current .....	4-33
Set the Power Factor (AC Power Only) .....	4-33
Set the Frequency (AC Energy Only) .....	4-33
Set the Meter Constant .....	4-33
Set the Test and Warm-up Periods .....	4-33
Set the Power in Modes Edc High I and Eac High I .....	4-34
Generate Voltage .....	4-34
Control in the Voltage Mode .....	4-34
Overload the Output Terminals .....	4-34
Set the Voltage in Modes Vdc Basic and Vac Basic .....	4-34
Set the Voltage .....	4-34
Set the Frequency (AC Voltage Only) .....	4-35
Generate Current .....	4-35
Control in the Current Mode .....	4-35
Overload the Output Terminals .....	4-36
Current Modes (Mode Softkey) .....	4-36
Set the Current in Modes Idc Basic and Iac Basic .....	4-36
Set the Current in Modes Idc High I and Iac High I .....	4-37
Use the Multimeter .....	4-37
Product Use Tips .....	4-38
Use the Isolated Current Outputs .....	4-38
Safe Working Practices .....	4-40
How to Connect the Product to the UUT .....	4-40
How to Disconnect the Product from the UUT .....	4-40
Use the Product to Power Energy Meters .....	4-41
<b>5 Verification, Calibration Adjustment, and Maintenance .....</b>	<b>5-1</b>
Introduction .....	5-1
Required Equipment .....	5-1
Verification Performance Tests .....	5-2
Configuration of the Product .....	5-2
Basic Steps of the Performance Verification Test .....	5-3
Connections and Procedure Sequences .....	5-3
VDC Amplitude Verification .....	5-4
Frequency Verification .....	5-4
Modulation Mode Voltage Amplitude Verification (0 % Modulation) .....	5-5
Voltage Modulation Mode Depth Verification .....	5-5
DC Current Amplitude Verification .....	5-6
AC Current Amplitude Verification .....	5-7
Voltage from the Current Terminals Amplitude Verification .....	5-8
Modulation Mode Current Amplitude Verification (0 % Modulation) .....	5-9
Current Modulation Mode Depth Verification .....	5-9
VAC Amplitude Verification .....	5-10
Power Amplitude Verification .....	5-11
Voltage Current Phase Verification .....	5-12
Current Voltage Phase Verification .....	5-12

Harmonic Mode Amplitude Verification .....	5-13
Interharmonic Mode Amplitude Verification .....	5-14
Harmonic Mode Voltage Phase Verification .....	5-14
Harmonic Mode Current Phase Verification .....	5-14
Multimeter Voltage Verification .....	5-15
Multimeter Frequency Verification .....	5-15
Multimeter Current Verification .....	5-16
Calibration Adjustment Principles .....	5-17
Access to the Calibration Adjustment Procedure .....	5-18
Select the Calibration Adjustment Type .....	5-19
Termination of the Calibration Adjustment Process .....	5-20
Calibration Points .....	5-21
Complete Calibration Adjustment Procedure .....	5-21
Enter the Calibration Menu .....	5-21
AC Voltage Ranges Calibration Adjustment .....	5-22
AC Current Ranges Calibration Adjustment .....	5-23
DC Voltage Ranges Calibration Adjustment .....	5-25
DC Current Ranges Calibration Adjustment .....	5-26
AC Voltage Modulation Ranges Calibration Adjustment (P Harmonic, P Interharmonic Modes) .....	5-28
AC Current Modulation Ranges Calibration Adjustment (P Harmonic, P Interharmonic Modes) .....	5-29
DC Voltage from the Current Outputs Calibration Adjustment .....	5-30
Meter Calibration Adjustment .....	5-30
10 V DC Voltage Range Calibration Adjustment .....	5-31
20 mA DC Current Range Calibration Adjustment .....	5-31
10 kHz Frequency Range Calibration Adjustment .....	5-32
Maintenance .....	5-33
Regular Maintenance .....	5-34
Clean the Product .....	5-34
Fuse Replacement .....	5-34
In Case of Failure .....	5-36
User-Replaceable Parts .....	5-36
<b>6 Error Messages .....</b>	<b>6-1</b>
Introduction .....	6-1





# List of Tables

Table	Title	Page
1-1.	Symbols.....	1-4
2-1.	Line Cords by Country.....	2-3
3-1.	The Product.....	3-2
3-2.	Front Panel Interface.....	3-3
3-3.	Inputs.....	3-5
3-4.	Outputs.....	3-6
3-5.	The Display .....	3-7
3-6.	Rear Panel .....	3-9
4-1.	AC Power Modes .....	4-16
4-2.	DC Power Modes .....	4-16
4-3.	AC Energy .....	4-32
4-4.	DC Energy.....	4-32
4-5.	AC Current .....	4-36
4-6.	DC Current .....	4-36
5-1.	Required Equipment.....	5-1
5-2.	Voltage AC function (Voltage AC#x) .....	5-22
5-3.	Current AC Function (Current AC#x) .....	5-24
5-4.	Voltage DC Function (Voltage DC#x).....	5-25
5-5.	Current DC Function (Current DC#x).....	5-26
5-6.	Voltage AC Modulation Function (Voltage MOD#x) .....	5-28
5-7.	AC Current Modulation Function (Current MOD#x) .....	5-29
5-8.	Voltage from Current DC Function (Voltage DC#x) .....	5-30
5-9.	Multimeter (Meter) .....	5-32
5-10.	Line Voltage Selection Fuses.....	5-34
5-11.	User Documentation.....	5-36
6-1.	Error Messages .....	6-2



# ***List of Figures***

<b>Figure</b>	<b>Title</b>	<b>Page</b>
2-1.	The Product with High-Current Adapter .....	2-4
3-1.	Numeric Entry.....	3-12
4-1.	Isolated Current Outputs .....	4-39
5-1.	Calibration Menu .....	5-18
5-2.	Voltage AC#1 Screen.....	5-19
5-3.	Voltage AC#1 Write Screen .....	5-20
5-4.	Fuse Replacement .....	5-35



# **Chapter 1**

## **Introduction**

### **Introduction**

The Fluke 6003A Three Phase Power Calibrator (the Product), is a precise instrument for the calibration of watt-hour meters, energy reference standards, and measuring devices used to determine the magnitude and quality of electrical power supplied to consumers. The Product can provide one, two, or three phases of electrical power and energy. It is equipped with a built-in multimeter, which can be used simultaneously with the Product output functions for transducer calibration of various types without the need for additional measuring instruments.

### **Contact Fluke Calibration**

To contact Fluke Calibration, call one of the following telephone numbers:

- Technical Support USA: 1-877-355-3225
- Calibration/Repair USA: 1-877-355-3225
- Canada: 1-800-36-FLUKE (1-800-363-5853)
- Europe: +31-40-2675-200
- Japan: +81-3-6714-3114
- Singapore: +65-6799-5566
- China: +86-400-810-3435
- Brazil: +55-11-3759-7600
- Anywhere in the world: +1-425-446-6110

To see product information or download manuals and the latest manual supplements, visit Fluke Calibration's website at [www.flukecal.com](http://www.flukecal.com).

To register your product, visit <http://flukecal.com/register-product>.

## Safety Information

A **Warning** identifies conditions and procedures that are dangerous to the user. A **Caution** identifies conditions and procedures that can cause damage to the Product or the equipment under test.

### Warnings

To prevent possible electrical shock, fire, or personal injury:









- Read all safety information before you use the Product.
- Carefully read all instructions.
- Two people are necessary to move or lift the Product. Always use correct lifting techniques. The Product has a mass of 62 kg.
- Use this Product indoors only.
- Do not use the Product around explosive gas, vapor, or in damp or wet environments.
- Do not use an extension cord or adapter plug.
- Do not put the Product where access to the mains power cord is blocked.
- Use only the mains power cord and connector approved for the voltage and plug configuration in your country and rated for the Product.
- Make sure the ground conductor in the mains power cord is connected to a protective earth ground. Disruption of the protective earth could put voltage on the chassis that could cause death.
- Replace the mains power cord if the insulation is damaged or if the insulation shows signs of wear.
- Examine the case before you use the Product. Look for cracks or missing plastic. Carefully look at the insulation around the terminals.
- Do not connect to live output terminals. The Product can supply voltages that can cause death. Standby mode is not sufficient to prevent electrical shock.
- Before changing the fuse, turn the Product off and remove the mains power cord. Stop for two minutes to let the power assemblies discharge before you open the fuse door.

- Do not apply more than the rated voltage, between the terminals or between each terminal and earth ground.
- Do not touch voltages > 30 V ac rms, 42 V ac peak, or 60 V dc.
- Use only cables with correct voltage ratings.
- Never connect the Product current output terminals to a voltage source other than the Product voltage output terminals.
- Use extreme caution around the output terminals. Lethal voltages may be present.
- Make sure the Product is in standby mode and external circuits are not energized before you connect or disconnect cables between the Product and the equipment under test.
- Do not enable voltage outputs unless the cables between the Product and equipment under test are connected or disconnected at both ends of the cable.
- Do not connect any connector or terminal, other than the mains power inlet, to line power.
- Whenever it is likely that safety protection has been impaired, the Product must be made inoperative and be secured against any unintended operation. Inform qualified maintenance or repair personnel. Safety protection is likely to be impaired if, for example, the Product shows visible damage or fails to operate normally.
- Use the Product only as specified, or the protection supplied by the Product can be compromised.
- Do not use the Product if it operates incorrectly.
- Do not operate the Product with covers removed or the case open. Hazardous voltage exposure is possible.
- Remove the input signals before you clean the Product.
- Use only specified replacement parts.
- Use only specified replacement fuses.
- Have an approved technician repair the Product.

## Symbols

The symbols shown in Table 1-1 can be found in this manual or on the Product.

Table 1-1. Symbols

Symbol	Description
	Hazardous voltage. Risk of electric shock.
	Risk of Danger. Important information. See Manual.
	Earth Terminal
	Conforms to relevant North American Safety Standards.
	Conforms to European Union directives.
	Conforms to relevant Australian EMC standards.
	Conforms to relevant South Korean EMC Standards.
	This product complies with the WEEE Directive (2002/96/EC) marking requirements. The affixed label indicates that you must not discard this electrical/electronic product in domestic household waste. Product Category: With reference to the equipment types in the WEEE Directive Annex I, this product is classed as category 9 "Monitoring and Control Instrumentation" product. Do not dispose of this product as unsorted municipal waste. Go to Fluke's website for recycling information.

## Protective Earth (Grounding)

The Product must be operated with a protective earth/ground connection via the protective earth/grounding conductor of the mains ac cable. The protective earth/ground connects before the ac line and neutral connections when the supply plug is inserted into the ac line supply socket on the Product rear panel. If the final connection to the ac line supply is made elsewhere, ensure that the protective earth/ground connection is made before ac line and neutral.

If there is a possibility the protective earth/ground connection might not be made before the ac line and neutral connections, or the output terminals are connected to a potentially hazardous live circuit, the separate protective earth/ground connection on the rear panel must be connected to a suitable protective earth/ground.

### Warning

**To prevent electrical shock or personal injury, do not intentionally or unintentionally interrupt the protective ground conductor inside or outside the Product. Interrupting the protective ground conductor is likely to make the Product dangerous. Intentional interruption is prohibited.**



## Features

The Product features:

- Traceable voltage, current, and power signals
- Configurable from one to three independent phases
- Full independent control of voltage and current on each phase
- 600 V ac (280 V dc) and 30 A available on each phase
- Up to 300 mA burden current on voltage outputs
- 5.5 V peak compliance on all current outputs up to 30 A
- High-current mode that generates up to 90 A into a single output
- Optional Energy counter (6003A/E Energy Option).
  - Frequency input for counting energy meter outputs up to 1 MHz
  - Pulse output proportional to Energy output, up to 1 MHz
- Optional Power Quality features (6003A/PQ Power Quality Option)
  - Non-sinusoidal voltage and current outputs with up to 63 harmonics and 1 interharmonic
  - Dips and swells on both voltage and current
  - Modulation to simulate flicker
  - User-definable waveforms, with the ability to save the actual setting into internal memory

## Specifications

This section gives the general and detailed specifications of the Product.

### Input Power

Voltage	115 V, 230 V $\pm$ 10 %
Frequency	47 Hz to 63 Hz
Maximum consumption	1875 VA max

### Dimensions

Height	415 mm (16.3 inches)
Height (without feet)	402 mm (15.8 inches)
Width	430 mm (16.9 inches)
Depth	640 mm (25.2 inches)
Weight	62 kg (136 lb)

## Environment

Operating temperature	5 °C to 40 °C
Calibration temperature (Tcal) range	21 °C to 25 °C
Storage temperature	-10 °C to 55 °C
Transit temperature	-15 °C to 60 °C
Warm up time	1 hour
Safe operating max. relative humidity (non-condensing)	<80 %, 5 °C to 31 °C ramping linearly down to 50 % at 35 °C
Storage max. relative humidity (non-condensing)	<90 %, -10 °C to 55 °C
Operating altitude	2,000 m maximum
Storage altitude	12,000 m maximum
Shock	MIL-PRF-28800F class 3
Vibration	MIL-PRF-28800F class 3
Enclosure	MIL-PRF-28800F class 3

## Safety

IEC61010-1, IEC 61010-2-030, Overvoltage category II, Pollution Degree 2

## EMC

IEC 61326-1, Controlled

## General Electrical

Voltage/Current amplitude setting resolution	5.5 digits
Range of fundamental frequencies	15 Hz to 1 kHz
Line frequency locking	45 Hz to 65.9 Hz at user discretion
Frequency accuracy	±50 ppm
Frequency setting resolution	0.001 Hz for 15 Hz to <500 Hz, 0.01 Hz 500 Hz to 1 kHz
Warm up time to full accuracy	The shorter of 1 hour or twice the time since last warmed up
Settling time following change to the output	3 seconds maximum
Nominal angle between voltage phases	120 °
Nominal angle between voltage and current of a phase	0 °
Phase angle setting	0 ° to 359.99 °
Phase angle setting resolution	0.01 °

## Electrical Specifications

The product specifications describe the Absolute Instrumental Uncertainty of the Product. The product specifications include stability, temperature, and humidity; within specified limits, linearity, line and load regulation, and the reference standard measurement uncertainty. The product specifications are stated at a confidence limit of 99 %,  $k=2.58$ , normally distributed.

### Temperature Coefficient

Add 0.1x spec /°C for temperature ranges outside of Tcal ±2 °C. For example, for Tcal = 23 °C, the specification at 11 °C and 35 °C is 2 times the nominal specification.

### Voltage

#### Voltage Channel Maximum Capacitive Loading for Output Stability

The voltage output remains stable up to a 100 nF load but may not be able to drive that capacitance at all voltage/frequency/harmonic combinations due to burden current limitations.

**Voltage Range Limits and Burden**

Range	1.0000 V to 10 V	10.0001 V to 30 V	30.001 V to 70 V	70.001 V to 140 V	140.001 V to 280 V	280.001 V to 600 V <sup>[1]</sup>
Maximum Burden Current (peak) 40 Hz - 70 Hz <sup>[2][4]</sup>	141 mA	283 mA	424 mA	424 mA	283 mA	85 mA
Maximum Burden Current (RMS) 40 Hz - 70 Hz <sup>[2][4]</sup>	100 mA	200 mA	300 mA	300 mA	200 mA	60 mA
Maximum Burden Current (RMS) dc, 15 Hz to 40 Hz, 70 Hz to 1000 Hz <sup>[2][4]</sup>	100 mA	200 mA	200 mA	200 mA	150 mA	50 mA <sup>[3][4]</sup>
<p>[1] 600 V range is ac only, and limited to the fundamental frequency, i.e. no additional harmonics can be generated</p> <p>[2] Sum of all currents from three phases is limited to 400 mA RMS</p> <p>[3] 600 V range cannot output dc.</p> <p>[4] Maximum burden current is reduced in Power Harmonic, Power Interharmonics and Dip/Swell modes by a factor of 0.707 times the values shown. For example, the maximum burden current for a 10 V, 50 Hz harmonic output is 70.7 mA.</p>						

**Voltage Sine Amplitude**

Ranges	Frequency	1-Year Specification, Tcal ±2 °C ± (% of output + V)	
1.0000 V to 10.0000 V	15 Hz to 40 Hz	0.016	1 mV
	40 Hz to 70 Hz	0.012	1 mV
	70 kHz to 1 kHz	0.016	1 mV
10.0001 V to 30.000 V	15 Hz to 40 Hz	0.016	3 mV
	40 Hz to 70 Hz	0.012	3 mV
	70 kHz to 1 kHz	0.016	3 mV
30.001 V to 70.000 V	15 Hz to 40 Hz	0.016	7 mV
	40 Hz to 70 Hz	0.012	7 mV
	70 kHz to 1 kHz	0.016	7 mV
70.001 to 140.000 V	15 Hz to 40 Hz	0.016	14 mV
	40 Hz to 70 Hz	0.012	14 mV
	70 kHz to 1 kHz	0.016	14 mV
140.001 V to 280.000 V	15 Hz to 40 Hz	0.016	28 mV
	40 Hz to 70 Hz	0.012	28 mV
	70 kHz to 1 kHz	0.016	28 mV
280.001 V to 600.000 V	20 Hz to 40 Hz	0.024	60 mV
	40 Hz to 70 Hz	0.016	60 mV
	70 kHz to 1 kHz	0.024	60 mV

**Voltage DC**

Range	1-Year Specification, Tcal ±2 °C ± (% of output + V)	
1.0000 V to 10.0000 V	0.015	1 mV
10.0001 V to 30.0000 V	0.015	3 mV
30.001 V to 70.0000 V	0.015	7 mV
70.001 V to 140.000 V	0.015	14 mV
140.001 V to 280.000 V	0.015	28 mV

**Voltage Distortion**

<0.05 % 15 Hz to 200 kHz bandwidth

**Current****Current Range Limits and Compliance**

Range	8.000 mA to 300.000 mA	0.30001 A to 1.00000 A	1.00001 A to 2.00000 A	2.00001 A to 5.00000 A	5.0001 A to 10.0000 A	10.0001 A to 30.0000 A	90 mA to 90.0000 A <sup>[1]</sup>
Maximum Compliance Voltage (dc/peak) <sup>[3]</sup>	8	8	8	5	5	5	5
Maximum Compliance Voltage (RMS) 15 Hz to 400 Hz <sup>[3]</sup>	5.5	5.5	5.5	3.5	3.5	3.5	3.5
Maximum Compliance Voltage (RMS) 400 kHz to 1 kHz <sup>[3]</sup>	3.5	3.5	3.5	3.5	3.5	3.5	3.5
Maximum Inductive Load <sup>[2]</sup>	1 mH	1 mH	1 mH	1 mH	1 mH	1 mH	1 mH

[1] 90 A range is available in the Current High I mode

[2] Voltage compliance developed across inductive loads may limit the maximum current output being achieved at higher frequencies. The maximum frequency (Fmax) for a given load inductance and current is given by  $F_{max} = V_c / (2 \cdot \pi \cdot I \cdot L)$ , where  $V_c$  is the maximum RMS compliance voltage.

[3] Maximum burden voltage is reduced in Power Harmonic, Power Interharmonic and Dip/Swell modes by 0.707 times the values shown above. For example, the maximum burden voltage for a 1 A, 50 Hz harmonic output is 3.89 V.

**Current Sine Amplitude**

Range (Amps)	Frequency	1-Year Specification, Tcal ±2 °C ±(% of output + A)	
8.000 mA to 300.000 mA	15 Hz to 40 Hz	0.021	60 µA
	40 Hz to 70 Hz	0.0175	30 µA
	70 Hz to 1 kHz	0.021	60 µA
0.30001 A to 1.00000 A	15 Hz to 40 Hz	0.021	200 µA
	40 Hz to 70 Hz	0.0175	100 µA
	70 Hz to 1 kHz	0.021	200 µA
1.00001 A to 2.00000 A	15 Hz to 40 Hz	0.021	400 µA
	40 Hz to 70 Hz	0.0175	200 µA
	70 Hz to 1 kHz	0.021	400 µA
2.00001 A to 5.00000 A	15 Hz to 40 Hz	0.021	1 mA
	40 Hz to 70 Hz	0.0175	500 µA
	70 Hz to 1 kHz	0.021	1 mA
5.0001 A to 10.0000 A	15 Hz to 40 Hz	0.028	2 mA
	40 Hz to 70 Hz	0.021	1.5 mA
	70 Hz to 1 kHz	0.028	2 mA
10.0001 A to 30.0000 A	15 Hz to 40 Hz	0.035	6 mA
	40 Hz to 70 Hz	0.0245	4.5 mA
	70 Hz to 1 kHz	0.035	6 mA
90 mA to 90.0000 A <sup>[1]</sup>	15 Hz to 40 Hz	0.035	18 mA
	40 Hz to 70 Hz	0.0245	13.5 mA
	70 Hz to 1 kHz	0.035	18 mA

[1] 90 A range is available in the Current High I mode

**Current DC**

Range	1-Year Specification, Tcal ±2 °C ±(% of output + A)	
8.000 mA to 300.000 mA	0.0175	30 µA
0.30001 A to 1.00000 A	0.0175	100 µA
1.00001 A to 2.00000 A	0.0175	200 µA
2.00001 A to 5.00000 A	0.0175	500 µA
5.0001 A to 10.0000 A	0.021	1.5 mA
10.0001 A to 30.0000 A	0.0245	4.5 mA
90 mA to 90.0000 A <sup>[1]</sup>	0.0245	13.5 mA

[1] 90 A range is available in the Current High I mode

**Current Distortion**

<0.1 %, 15 Hz to 200 kHz bandwidth

**Current Output Isolation (high or low terminal)**

450 V peak maximum above earth ground. The current output terminals must only be energized by the Product Voltage output terminals.

**Voltage from the Current Terminals (DC and Sine Wave Only)****Range Limits and Impedances**

Range	1.000 mV to 20.000 mV	20.001 mV to 330.000 mV	0.33001 V to 5.00000 V
Source Impedance	1 $\Omega$	1 $\Omega$	18 $\Omega$
Minimum load impedance to maintain specification	25 k $\Omega$	25 k $\Omega$	450 k $\Omega$

**Voltage from Current Terminals**

Range	Frequency	1-Year Specification, Tcal 2°C $\pm$ (% of output + V)	
1.000 mV to 20.000 mV	dc	0.05	20 $\mu$ V
	15 Hz to 400 Hz	0.05	20 $\mu$ V
20.001 mV to 330.000 mV	dc	0.05	200 $\mu$ V
	15 Hz to 400 Hz	0.05	200 $\mu$ V
0.33001 V to 5.00000 V	dc	0.05	1 mV
	15 Hz to 400 Hz	0.05	1 mV

**Voltage from Current Terminals, Distortion**

<0.1 %, 15 Hz to 200 kHz bandwidth

**Phase and Power Factor (Sine Wave Outputs)**

Phase range	0.0 $^{\circ}$ to 359.99 $^{\circ}$
Frequency range	15 Hz to 1 kHz
Phase resolution	0.01 $^{\circ}$
Power factor range	-1 to +1 (Lead, Lag)
Power factor resolution	0.001
Power factor accuracy	$(1 - \cos(\varphi+d\varphi)/\cos \varphi)$ where $\varphi$ is the phase in degrees and $d\varphi$ is the phase specification in degrees.

**Current to Voltage Phase**

For All Voltage Outputs (1 V to 600 V)		
Current Output	Frequency	1-Year Specification, Tcal $\pm$ 2 $^{\circ}$ C
0.008 A to 0.099999 A	15 Hz to 70 Hz	0.05 $^{\circ}$
	70 Hz to 400 Hz	0.1 $^{\circ}$
	400 kHz to 1 kHz	0.4 $^{\circ}$
0.1 A to 10 A	15 Hz to 70 Hz	0.01 $^{\circ}$
	70 Hz to 400 Hz	0.1 $^{\circ}$
	400 kHz to 1 kHz	0.4 $^{\circ}$
10.0001 A to 30 A	15 Hz to 70 Hz	0.05 $^{\circ}$
	70 Hz to 400 Hz	0.1 $^{\circ}$
	400 kHz to 1 kHz	0.4 $^{\circ}$

For voltage from the current terminals, use the 0.1 A to 10 A phase specification for > 40 % of range and 0.008 A to 0.099999 A for  $\leq$ 40 % of range. There are three voltage ranges, 20 mV, 330 mV and 5 V.

### Voltage to Voltage Phase

For All Voltage Ranges (1 V to 600 V)	
Frequency	1-Year Specification, Tcal ±2 °C
15 Hz to 70 Hz	0.01 °
70.001 Hz to 400 Hz	0.1 °
400.001 kHz to 1 kHz	0.4 °

### Power

The power specifications below are valid for sinusoidal outputs for voltage, current, and frequencies shown. They are not valid when any harmonics, modulation (flicker), interharmonics, or dips/swells are applied.

To calculate the power specification for any specific voltage, current, and power factor outputs, use this formula:

$$dP = \sqrt{(dV^2 + dI^2 + dPF^2 + 0.01^2)} \text{ (\%)}$$

where dV is the specification of the voltage, dI is the specification of the current, dPF is the specification of the power factor; all expressed as a %.

Example calculations:

Output 230 V, 20 A, PF = 1. 230 V has a specification of (0.012 % of output + 28 mV) or 0.024 %. 20 A has a specification of (0.0245 % + 4.5 mA), or 0.047 %. The phase specification for this output is 0.05 °. At PF = 1 the power factor specification is 0.0000 %. Applying the power specification formula, this gives

$$\sqrt{(0.024^2 + 0.047^2 + 0.00^2 + 0.01^2)} = 0.054 \%$$

Output 115 V, 3 A, PF = 0.8. 115 V has a specification of (0.012 % of output + 14 mV) or 0.024 %. 3 A has a specification of (0.0175 % + 500 μA), or 0.034 %. The phase specification for this output is 0.01 °. At PF = 0.8 the power factor specification is 0.0131 %. Applying the power specification formula, this gives

$$\sqrt{(0.024^2 + 0.034^2 + 0.0131^2 + 0.01^2)} = 0.045 \%$$

Output 280 V, 5 A, PF = 0.5. 280 V has a specification of (0.012 % of output + 28 mV) or 0.022 %. 5 A has a specification of (0.0175 % + 500 μA), or 0.028 %. The phase specification for this output is 0.01 °. At PF = 0.5 the power factor specification is 0.0302 %. Applying the power specification formula, this gives

$$\sqrt{(0.022^2 + 0.028^2 + 0.0302^2 + 0.01^2)} = 0.047 \%$$

### Sinusoidal Power Specification at 40 Hz to 70 Hz, Power Factor 1.0 (%)

Current Output	Voltage Output					
	10 V	30 V	70 V	140 V	280 V	600 V
1.00000 A	0.037	0.037	0.037	0.037	0.037	0.039
5.00000 A	0.037	0.037	0.037	0.037	0.037	0.039
10.0000 A	0.043	0.043	0.043	0.043	0.043	0.046
30.0000 A	0.046	0.046	0.046	0.046	0.046	0.048

### Sinusoidal Power Specification at 40 Hz to 70 Hz, Power Factor 0.8 (%)

Current Output	Voltage Output					
	10 V	30 V	70 V	140 V	280 V	600 V
1.00000 A	0.039	0.039	0.039	0.039	0.039	0.041
5.00000 A	0.039	0.039	0.039	0.039	0.039	0.041
10.0000 A	0.045	0.045	0.045	0.045	0.045	0.047
30.0000 A	0.080	0.080	0.080	0.080	0.080	0.081

**Sinusoidal Power Specification at 40 Hz to 70 Hz, Power Factor 0.5 (%)**

Current Output	Voltage Output					
	10 V	30 V	70 V	140 V	280 V	600 V
1.00000 A	0.047	0.047	0.047	0.047	0.047	0.049
5.00000 A	0.047	0.047	0.047	0.047	0.047	0.049
10.0000 A	0.053	0.053	0.053	0.053	0.053	0.055
30.0000 A	0.158	0.158	0.158	0.158	0.158	0.158

**DC Power Specification (%)**

DC power is calculated as  $dP = \sqrt{(dV^2 + dI^2 + 0.01^2)} (\%)$

Current Output	Voltage Output				
	10 V	30 V	70 V	140 V	280 V
5.00000 A	0.038	0.038	0.038	0.038	0.038
10.0000 A	0.045	0.045	0.045	0.045	0.045
30.0000 A	0.048	0.048	0.048	0.048	0.048

**Multimeter**

Function	Measuring Range	1-year Specification, Tcal $\pm 2^\circ\text{C}$ (% of reading + floor)	Resolution
DC Voltage	0 V to $\pm 12$ V	0.01 % + 1 mV	100 $\mu\text{V}$
DC Current	0 mA to $\pm 25$ mA	0.01 % + 2.5 $\mu\text{A}$	100 nA
Frequency	1 Hz to 15 kHz	0.005 %	10 $\mu\text{Hz}$ to 0.1 Hz

**IN2 Input**

Input IN2 (trigger, synchronization)	
Max frequency	10 kHz
Input low level max	0.8 V
Input low level min	3.5 V

**Energy (6003A/E Energy Option)****Pulse Inputs (IN1)**

Max frequency	1 MHz (400 Hz with Input Filter On)
Min pulse width	500 ns
Max counts	5 000 000 000
Voltage high and low limits	low level max 0.8 V, high-level min. 3.2 V

**Energy Pulse Output**

Drive	Open collector
Frequency range	0.02 Hz to 1 MHz
Frequency specification	50 ppm of output
External pull-up	150 $\Omega$ , selectable on/off
Sink current	100 mA

**Energy**

Time range	1 to 1 000 000 seconds
Time resolution	0.1 seconds
Time interval specification	0.01 % of time interval + 0.1 seconds

**Test Duration**

Maximum test duration	1000 hours
-----------------------	------------



## Power Quality (6003A/PQ Power Quality Option)

### Voltage and Current Sinusoidal and Rectangular Modulation Flicker Specification

Modulation depth	0 to 30 %
Modulation depth specification	0.2 % of modulation depth
Modulation depth setting resolution	0.001 %
Shape of modulation envelope	Rectangular or Sinusoidal
Duty cycle (shape = rectangular)	1 % to 99 %
Modulating frequency specification	50 ppm of output
Modulation frequency range	0.001 Hz to 50 Hz
RMS amplitude specification	0.2 % of range
Fundamental frequency range	15 Hz to 1 kHz
Harmonic (2 to 63) frequency range	30 Hz to 5 kHz
<p>[1] For a given modulation %, the output signal swings between (output setting + modulation %) and (output setting - modulation %). The Fluke 6100 Series Electrical Power Standard defines modulation as <math>\Delta V/V\%</math>, where its output signal swings between (output setting + <math>\frac{1}{2} \Delta V/V\%</math>) and (output setting - <math>\frac{1}{2} \Delta V/V\%</math>). To get the same modulation as the 6100 series, set the 6003A modulation to <math>\frac{1}{2}</math> the <math>\Delta V/V\%</math> setting of the 6100.</p>	

### Harmonics and Interharmonic

Interharmonics are available on voltage and current outputs.

Fundamental harmonic frequency range	15 Hz to 1 kHz
Fundamental harmonic amplitude specification	$\pm 0.2\%$ of range
Harmonics (2 to 63) frequency range	30 Hz to 5 kHz
Interharmonic frequency range	15 Hz to 1 kHz
Maximum harmonic number	63
Number of interharmonic products	1
Frequency specification	$\pm 0.005\%$ of output
Fundamental harmonic phase specification	15 Hz to 70 Hz: $0.2^\circ$
	70 Hz to 400 Hz: $0.5^\circ$
	400 Hz to 1 kHz: $1^\circ$
Harmonics (2 to 63) phase specification	$5 \mu s$ <sup>[1]</sup>
Voltage harmonic and interharmonic amplitude specification (1 V to 280 V)	30 Hz to 3 kHz: 0.1 % of range
	3 kHz to 5 kHz: 0.2 % of range
Current harmonic and interharmonic amplitude specification (8 mA to 2 A)	30 Hz to 3 kHz: 0.1 % of range
	3 kHz to 5 kHz: 0.2 % of range
Current harmonic and interharmonic amplitude specification (2 A to 10 A)	30 Hz to 3 kHz: 0.2 % of range
	3 kHz to 5 kHz: 0.4 % of range
Current harmonic and interharmonic amplitude specification (10 A to 30 A)	30 Hz to 3 kHz: 0.2 % of range
	3 kHz to 5 kHz: 0.8 % of range
Maximum amplitude of harmonic products	30 % of RMS output value
Harmonic resolution of harmonic products	0.001 %
Noise and Distortion	-60 dB
<p>[1] Into resistive loads. For Current outputs, harmonics &gt; 3 kHz and/or &gt; 1.5 V rms compliance on the composite waveform, the specification is <math>10 \mu s</math>. The phase accuracy of a given harmonic is given by <math>P = 5 \mu s / (1/f) \times 360</math> where P = phase accuracy in degrees, f = harmonic frequency</p>	

**Dip/Swell**

Although Dips and Swells are primarily voltage phenomena, the Product provides the same facility on its current output.

AC voltage range	0.1 V to 280 V
AC current range	1 mA to 30 A
Amplitude accuracy	0.2 % of range <sup>[1]</sup>
Frequency range	15 Hz to 1 kHz
Timing <sup>[2]</sup>	
T1 range	0 s to 60 s
T2 range	0.1 ms to 60 s
T3 range	2 ms to 60 s
T4 range	0.1 ms to 60 s
T5 range	0 s to 60 s
[1] Range is determined by the highest value of the output signal	
[2] T1 + T5 > 2 ms	

**Note**

*Maximum voltage burden and current compliance is reduced in Power Quality functions. See Voltage Range Limits and Burden and Current Range Limits and Compliance above.*

# Chapter 2

## Installation

### Introduction

#### Warning

**To prevent electrical shock, personal injury, use extreme caution when working with the Product binding posts. The Product can supply lethal voltages to the binding posts.**

This chapter provides instructions to unpack and install the Product. The procedures for fuse replacement and connection to line power are provided here. Before Product use, read this chapter.

Instructions for cable connections, other than line power connection, can be found in the subsequent chapters of the manual:

- Voltage and current output connections and instructions for use of the 6003A test cable set are in Chapter 4.
- IEEE-488 and USB interface bus connection information is in Chapter 5.

### Unpack and Inspection

The Product is shipped in a container designed to prevent damage during shipping.

Inspect the Product carefully for damage and immediately report any damage to the shipper. Instructions for inspection and claims are included in the shipping container.

A packing list is included in the packaging. When you unpack the Product, check for all the standard equipment listed and check the shipping order for any additional items ordered. Report any shortage to the place of purchase or to the nearest Fluke Calibration Service Center.

### Reship the Instrument

Fluke Calibration recommends that the original container be used to reship the Product.

## Placement

The Product is to be used in controlled electromagnetic environments such as calibration and measurement laboratories. R.F. transmitters, such as cell phones, are not to be used in close proximity to the Product.

The Product is suitable for bench top use. Make sure there is sufficient space on the rear panel to allow adequate ventilation.

## Cooling Considerations

### Caution

**Damage caused by overheating may occur if the area around the air intake is restricted, or the intake air is too warm.**

The Product must be at least 4 inches from nearby walls or rack enclosures on the rear. The inlet and exhaust openings on the rear must be clear of obstruction.

Air enters the Product through ventilation hole #4 (see Chapter 3 for the location of the ventilation holes). The air that enters the Product must be between 5 °C and 40 °C. Make sure that exhaust from another instrument is not directed into the fan inlet. Holes #1-3 are for the exhaust of each respective channel.

Check the fan openings every 30 days or more frequently if the Product is operated in a dusty environment. Inlet hole #4 must be clear of dust and debris.

## Line Voltage

The Product has mains settings for 115 V or 230 V, depending on the line voltage selection.

## Line Voltage Fuse

The Product includes a fuse located in the mains connector on the rear panel (see Chapter 3 for the location of the mains fuse and multimeter fuse). Use the fuse specified for 115 V or 230 V operation. To change the fuse, see the *Maintenance* section in Chapter 6.

## Connect to Line Power

### ⚠⚠ Warning

To prevent electrical shock, personal injury, or fire:

- **Connect the factory-supplied three conductor line-power cord to a properly grounded power outlet.**
- **Do not use a two conductor adapter or extension cord. This will break the protective ground connection. If a two-conductor power cord must be used, a protective grounding wire must be connected between the ground terminal on the rear panel and ground before connecting the power cord or operating the Product.**

The line current requirement of the Product may exceed the capacity of standard 10 A IEC connectors so the Product is fitted with a 20 A power receptacle at the rear.

A suitable supply lead is provided. Make sure that the mains supply outlet is suited to delivering the 1875 VA maximum power requirements and that the Product is connected to a properly grounded three-prong outlet. See Table

**Table 2-1. Line Cords by Country**

Country	Line Cord Part Number
UK	2238596
Europe	2238615
Australia, New Zealand, China	1998198
USA	2238680
Japan (no plug fitted)	1998211

## Preparation for Operation

### Inspect Package Contents, Installation Location

The basic package includes these items:

6003A Three Phase Power Calibrator (main unit)

- Mains power cord
- Spare fuse
- Printed Safety Information
- Documentation CD
- Test Report
- Twelve test cables (three voltage sets and three current sets)

### Installation Power and Location

The Product should be powered by 230 V/115 V – 50/60 Hz mains. It is a laboratory instrument which has parameters guaranteed at  $T_{cal} \pm 2 \text{ } ^\circ\text{C}$ . Before powering on the Product, place it on a level surface. Do not cover the fan openings on the rear panel.

### Optional 90 A High Current Adapter

The 90 A High Current adapter is an optional accessory to allow for convenient hookup in the High I mode. The High I mode parallels all three current channels and can provide a maximum of 90 A output in a single phase. The 90 A High Current adapter comes with two high current cables for connecting to the Unit Under Test and a shorting plug. See Figure 2-1.

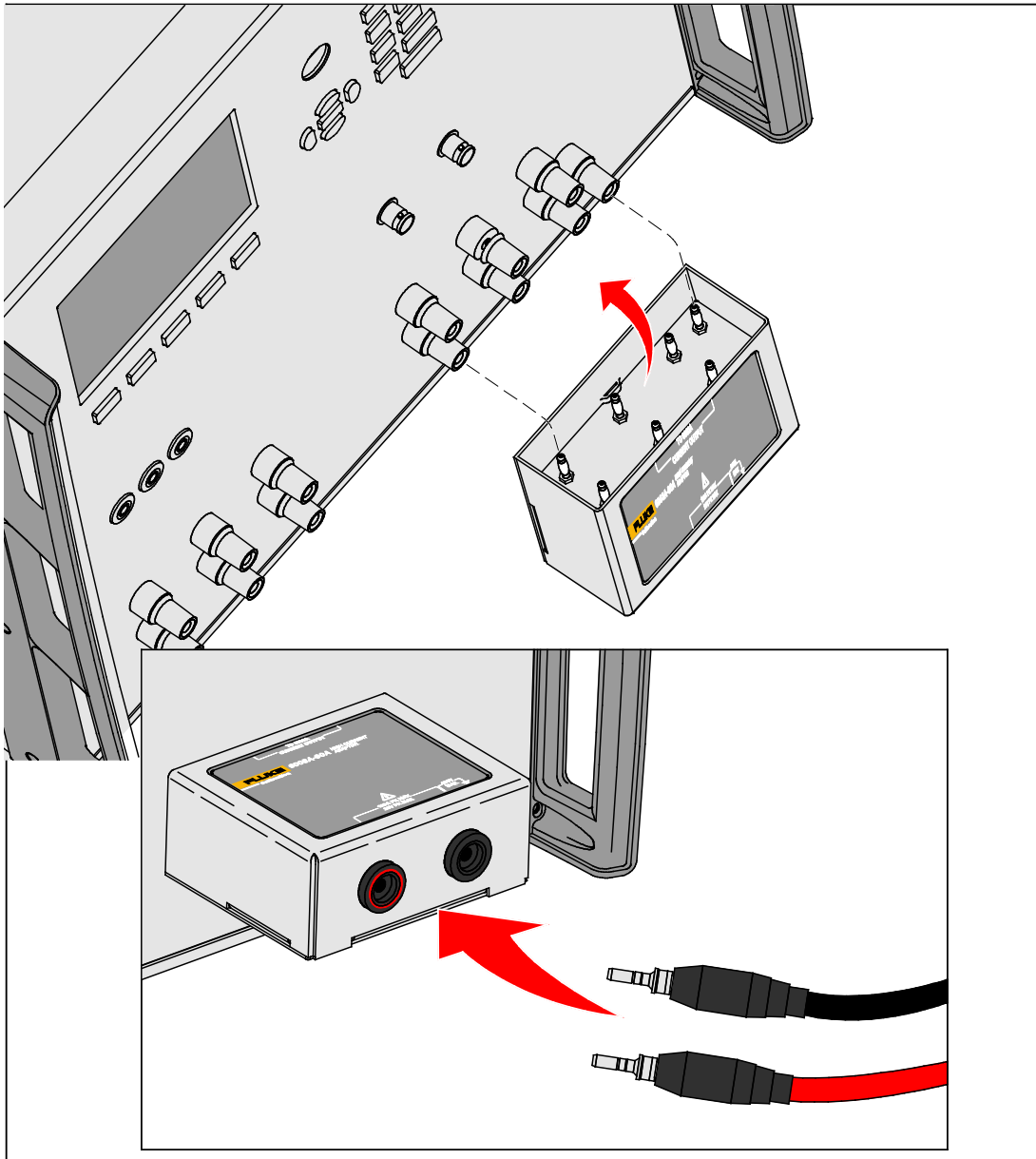

Figure 2-1. The Product with High-Current Adapter

hoa012.eps

**Power-on**

Before you connect the Product to mains power, check the position of the mains voltage selector located on the rear panel.

To power on the Product:

- Plug the female end of the power cord into the connector located on the rear panel and connect the male end of the power cord to a wall outlet.
- Switch on the mains switch located at the rear panel.
- The Product does an internal hardware checks for 5 seconds. The configuration of the Product is shown at the end of this test on the display:



- unit is connected and ready



- unit is connected, but channel is not found

After the tests conclude, the Product resets to its reference state. The subsequent parameters are set:

Function	AC power Pac Basic
Voltage range	10 V
Set value	10 V
Current range	1 A
Set value	1 A
Phase	0°
Frequency	50 Hz
Output terminals	OFF

The GPIB address of the Product is factory preset to 2. This value is valid until the user changes it.

*Note*

*The Product resets to its reference state when power is removed and reconnected.*

**Warmup**

The Product is ready for use after it is switched on and its initial checks are complete. However, specified parameters (see the *Specifications* section) are only guaranteed after the Product warms up for 60 minutes. During this period, the Product cannot be calibrated. The display shows “**cannot access the calibration**” if calibration is attempted during this period.





# **Chapter 3**

## ***Features and Basic Operation***

### ***Introduction***

This chapter is a reference for the functions and locations of the Product front and rear-panel features. Brief descriptions of each feature for quick access are also provided. Please read this information before operating the Product.

Front-panel operation instructions are provided in Chapter 4. Remote Operation instructions are provided in Chapter 5.

### ***Front-Panel Features***

The Product front panel is divided into three basic sections, see Table 3-1.

- User Interface, see Table 3-2.
- Inputs, see Table 3-3.
- Outputs, see Table 3-4.

Table 3-1. The Product

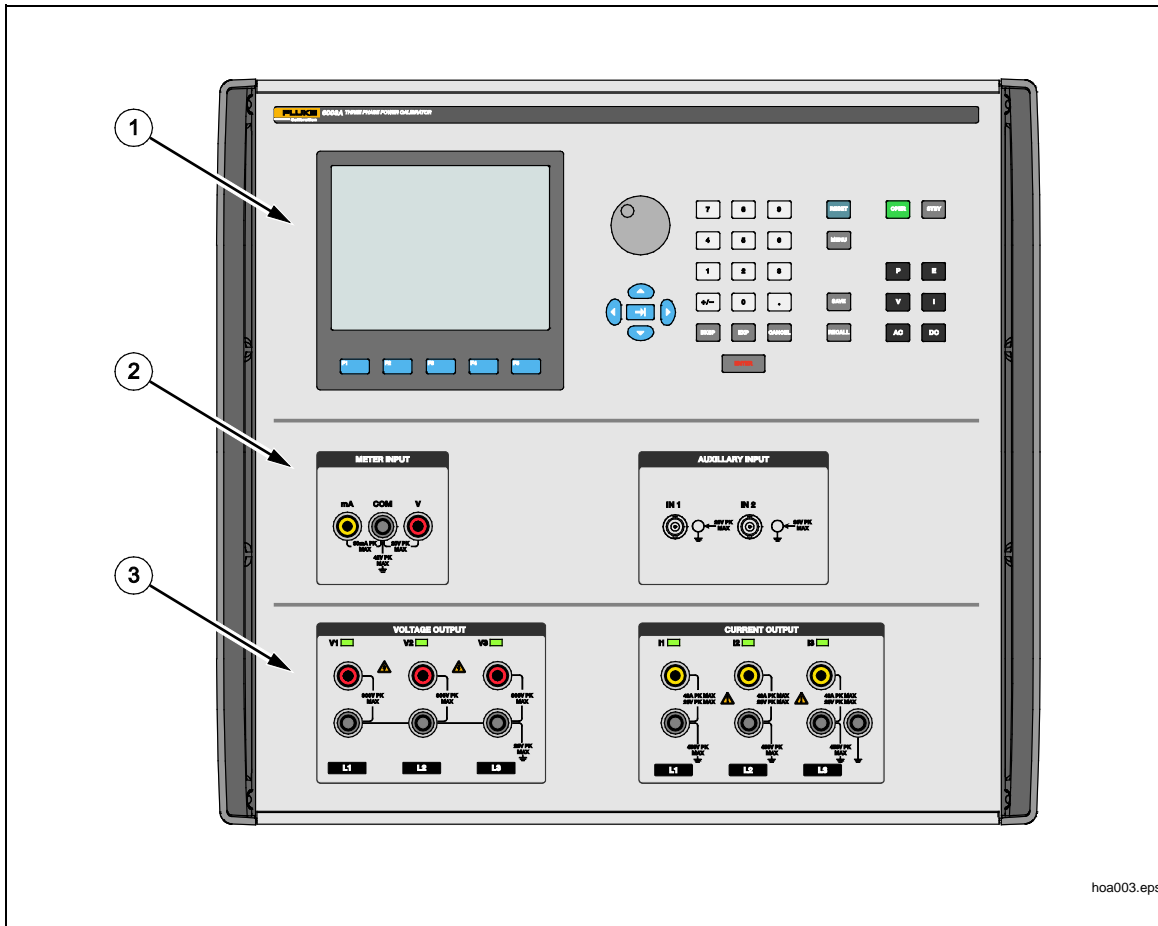

hoa003.eps

Number	Description
①	Front Panel Interface
②	Inputs
③	Outputs

Table 3-2. Front Panel Interface

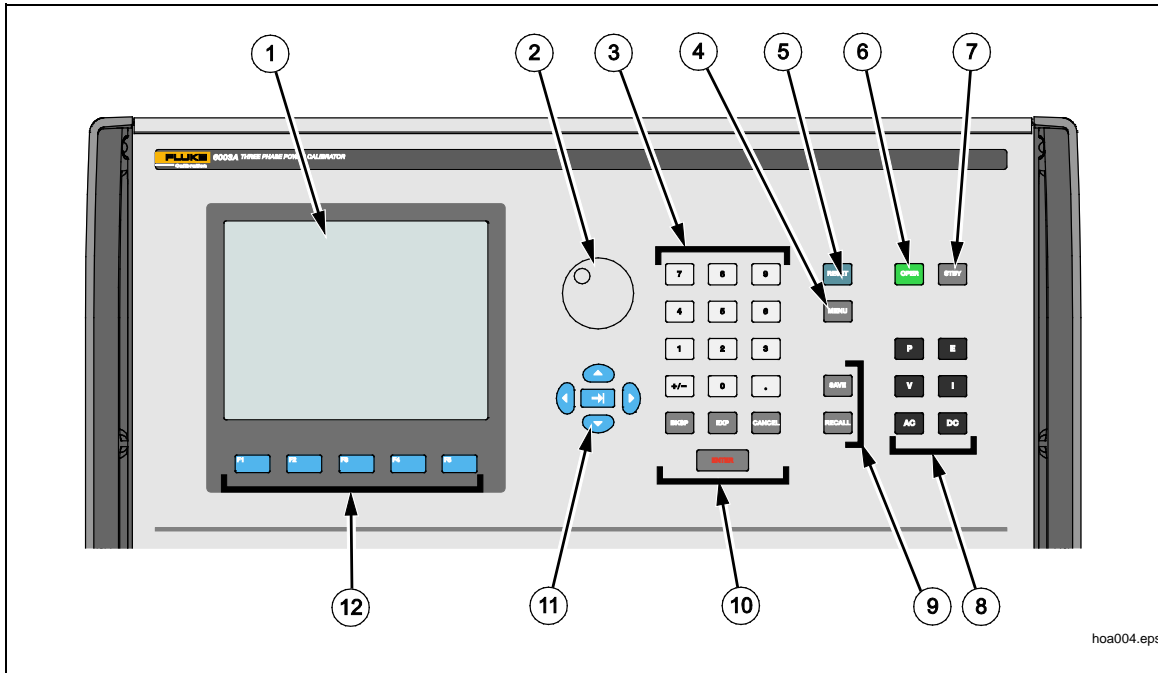

Number	Description
①	The <b>Display</b> . See Table 3-5 for a complete explanation.
②	<b>Rotary Knob</b> – The knob has several functions. Push in the knob to edit the main display of each function. Turn the knob left or right to change the numeric value. Push the knob again to move to the left or right of the present digit. Note that the functions of the rotary knob can also be performed by the cursor buttons.
③	<b>Numeric Keypad</b> – Use the keypad to enter numeric values on the display. Confirm the selection with the ENTER button. Use the CE button to cancel the entry.
④	<b>MENU</b> button is used to open the Main Setup menu of the Product to change General, Interface, Calibrator, Meter, and Calibration settings.
⑤	<b>RESET</b> button is used to reset the Product at any time.
⑥	<b>OPERATE</b> button enables the outputs and places them at the output binding posts. The green LED on the button illuminates.
⑦	<b>STANDBY</b> button disconnects the output from the output binding posts. The orange LED on the button illuminates.

Table 3-1. Front Panel Interface (cont.)

Number	Description
⑧	<p><b>P, E, V, and I</b> buttons put the Product into one of its four functions: Power, Energy, Voltage, or Current. When a function is changed, the parameters of the respective function are restored. If the respective function was never used, the Product uses the default values.</p> <p><b>AC and DC</b> buttons change the outputs to either AC or DC.</p>
⑨	<p><b>SAVE</b> and <b>RECALL</b> buttons can be used to save and recall the actual setting of the Product (all values including parameters). Capacity of the memory is a maximum of 100 different settings. Each setting contains a simple text description that is edited with the rotary knob.</p>
⑩	<p><b>BKSP</b>            Push to back space.</p> <p><b>EXP</b>             Push to add an exponent to a numerical value.</p> <p><b>CANCEL</b>        Push to abort an entry.</p> <p><b>ENTER</b>         After a value is entered with the other buttons, push this button to enter it.</p>
⑪	<p><b>Navigation Buttons</b> – Use these buttons to control the cursor within allowed limits on the display. The navigation buttons include two arrow buttons (&lt;, &gt;) that allow the cursor to be set to the required digit on the display field. The center “tab” button is used to step through the display fields. The two up and down buttons can be used to set numeric values.</p>
⑫	<p><b>Softkeys</b> – There are five buttons below the display. These buttons correspond to the function that is shown above each button on the display. Functionality of these softkeys is dependent upon how the Product is set. Once a softkey button is pushed, an “Exit” label appears as the right-most softkey and is used to move back to a previous level of softkeys.</p>

Table 3-3. Inputs

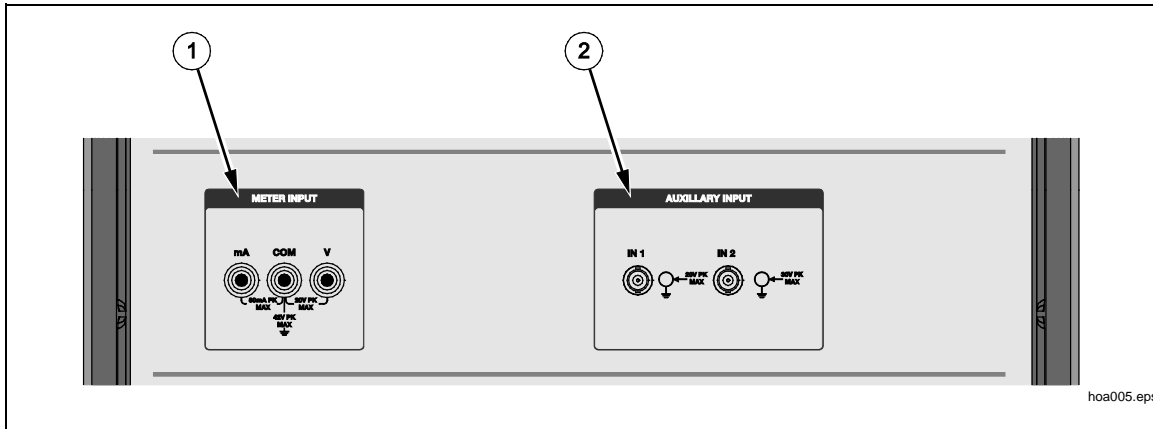

hoa005.eps

Number	Description
①	<b>Meter Inputs</b> - The COM terminal is common for all measurements. The V terminal is for dc voltage (up to 12 V) or frequency (up to 10 kHz) measurements. The mA terminal is for dc current measurement (up to 25 mA). The active measurement mode is set in the Main Menu. Multimeter measurement is available in the Power, Voltage, and Current functions.
②	<b>Auxiliary Input</b> - IN1 (active with 6003A/E Energy Option) is a frequency counter that counts the pulses from an energy meter. The meter constant is set in the Energy function display. IN2 is a synchronization input that allows the Product ac outputs and dips and swells to be synchronized with an external signal.

Table 3-4. Outputs

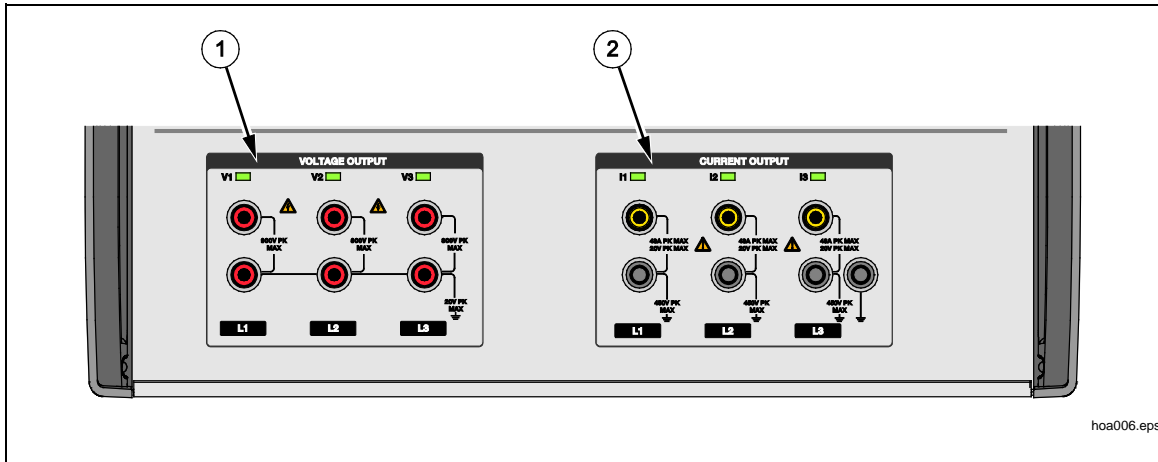

hoa006.eps

Number	Description
①	<p><b>Voltage Output</b> - Voltage outputs Hi and Lo terminals. Active outputs are selected in either the Main Menu or in the Power Extended modes. The Lo terminals can be grounded using the Main Menu, or allowed to float up to 20 V peak.</p>
②	<p><b>Current Output</b> - Current outputs Hi and Lo terminals, and an earth ground terminal. Active outputs are selected in either the Main Menu or in the Power Extended modes. The Lo terminals can be grounded using the Main Menu, or allowed to float up to 450 V peak as long as the Voltage output is 280 V or less. The Lo terminals are automatically grounded when the output voltage exceeds 280 V. The three Current outputs are put into parallel in the Power, Energy and Current High I modes. The optional 90 A adapter and high current test cables are recommended when using the High I mode. The 90 A output can be allowed to float up to 450 V peak as long as the Voltage output is 280 V or less. The Lo terminal is automatically grounded when the output voltage exceeds 280 V. Note that the adapter uses the earth ground terminal to ground its shell.</p>

**The Display**

The display is explained in Table 3-5.

**Table 3-5. The Display**

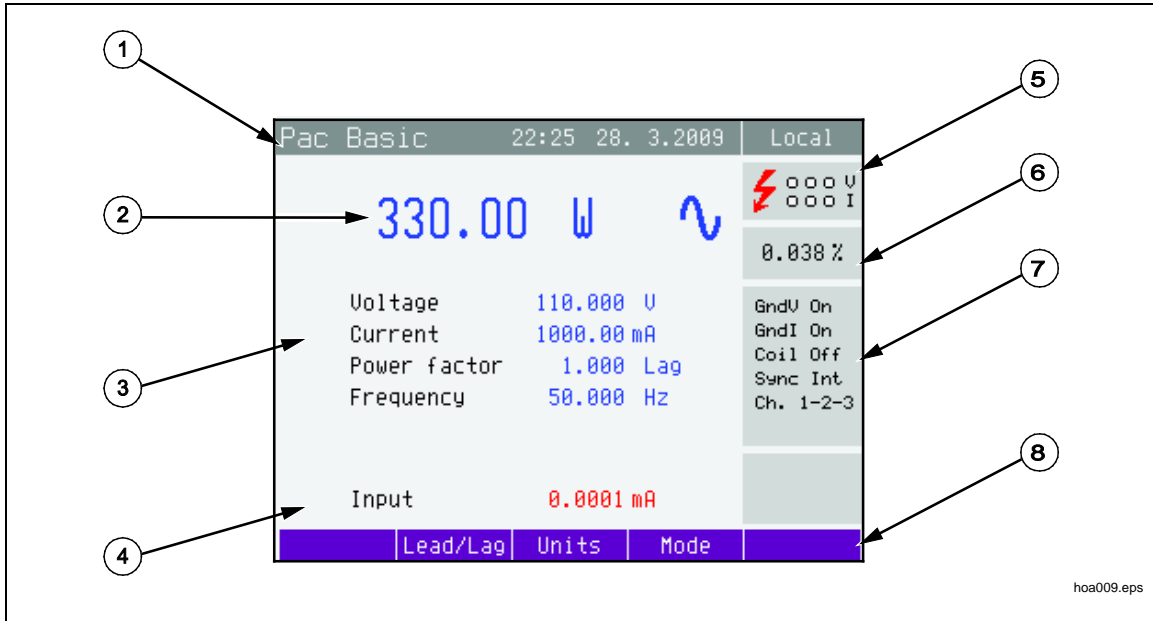

Item	Description
①	<b>Information Line</b> - Shows the selected function (Pac Basic - AC Power basic mode), Time and Date, and Remote control state (Local - keyboard, Remote - computer).
②	<b>Main Value</b> - The main output value is shown with the unit and indication of ac or dc (icon). The position of the cursor (▼▲) is also shown if the parameter is in edit mode. Position of the cursor can be changed with ◀ or ▶ or by pushing in the rotary knob. Parameter can be changed with ⏪, ⏩, or the rotary knob. If the output voltage is >50 V, an indication of dangerous voltage is shown in section 5.
③	<b>Auxiliary Parameters</b> This section shows auxiliary parameters of the selected function: <ul style="list-style-type: none"> <li>• Voltage (for Power, Energy, and V functions)</li> <li>• Current (for Power, Energy, and I functions)</li> <li>• Phase / Power factor (Power and Energy functions)</li> <li>• Frequency (ac outputs)</li> <li>• Meter constant (Energy)</li> <li>• Control mode parameters (Energy)</li> </ul>
④	<b>Measured Value</b> - Value measured with the internal multimeter of the Product. Value “over” is shown if the measured signal is out of range. The multimeter is available in Power, Voltage, and Current functions and is used to measure dc voltage, dc current, or frequency outputs from power transducers.

Table3-5. The Display (cont.)

Item	Description
⑤	<p><b>Outputs State</b> - Window shows which phases are on (one to three phases) when in OPERATE, and also shows the red danger voltage symbol when any output voltage is <math>\geq 50</math> V.</p> <p>Symbols shown in window:</p> <ul style="list-style-type: none"> <li>⚡ - warning, shown if output voltage is <math>\geq 50</math>V.</li> <li>○ - output is off</li> <li>● - output is on (the ○ is green)</li> </ul>
⑥	<p><b>Specification</b></p> <p>The specification of the main parameter is shown. The BUSY label is shown instead of accuracy, if the Product is not within specified parameters or if internal reconnection is in process. This can occur during changing of the functions, changing of set parameters, or switching output terminals to OPERATE from STANDBY. Specification is not available in power functions "P Harmonic", "P Interharmonic", and Dip and Swell.</p>
⑦	<p><b>Information Section</b></p> <p>The information section, located in the right part of the display, shows additional information related to the selected:</p> <ul style="list-style-type: none"> <li>• Information about the grounding method of output terminals GndV, GndI as set up with the menu "Calibrator".</li> <li>• Information about the use of 25-turn or 50-turn coil as set up with the menu "Calibrator".</li> <li>• Information about the synchronization of the ac output (internal, power line, external IN2).</li> <li>• Information about the number of active output channels (phases) applicable to functions "Power Pac" and "Energy Eac".</li> </ul>
⑧	<p><b>Display Softkeys</b></p> <p>The functions of these keys change during operation (depends on the actual display mode). Whenever a softkey is pushed, an EXIT softkey appears on the right side. This returns the Product to the main softkey screen.</p>
<p><b>Colors on Display:</b></p> <p>Various rules are used for the different colors on the display:</p> <ol style="list-style-type: none"> <li>1. Red is applied when the value shown is measured by the Product.</li> <li>2. Blue is applied for parameters or values that can be set-up or modified directly from the front panel keyboard or with the Main Setup menu.</li> <li>3. Black is used for fixed values, labels, notes, and parameters that cannot be modified and for other fixed text with general information.</li> </ol>	



**Rear Panel**

The rear panel is explained in Table 3-6.

**Table 3-6. Rear Panel**

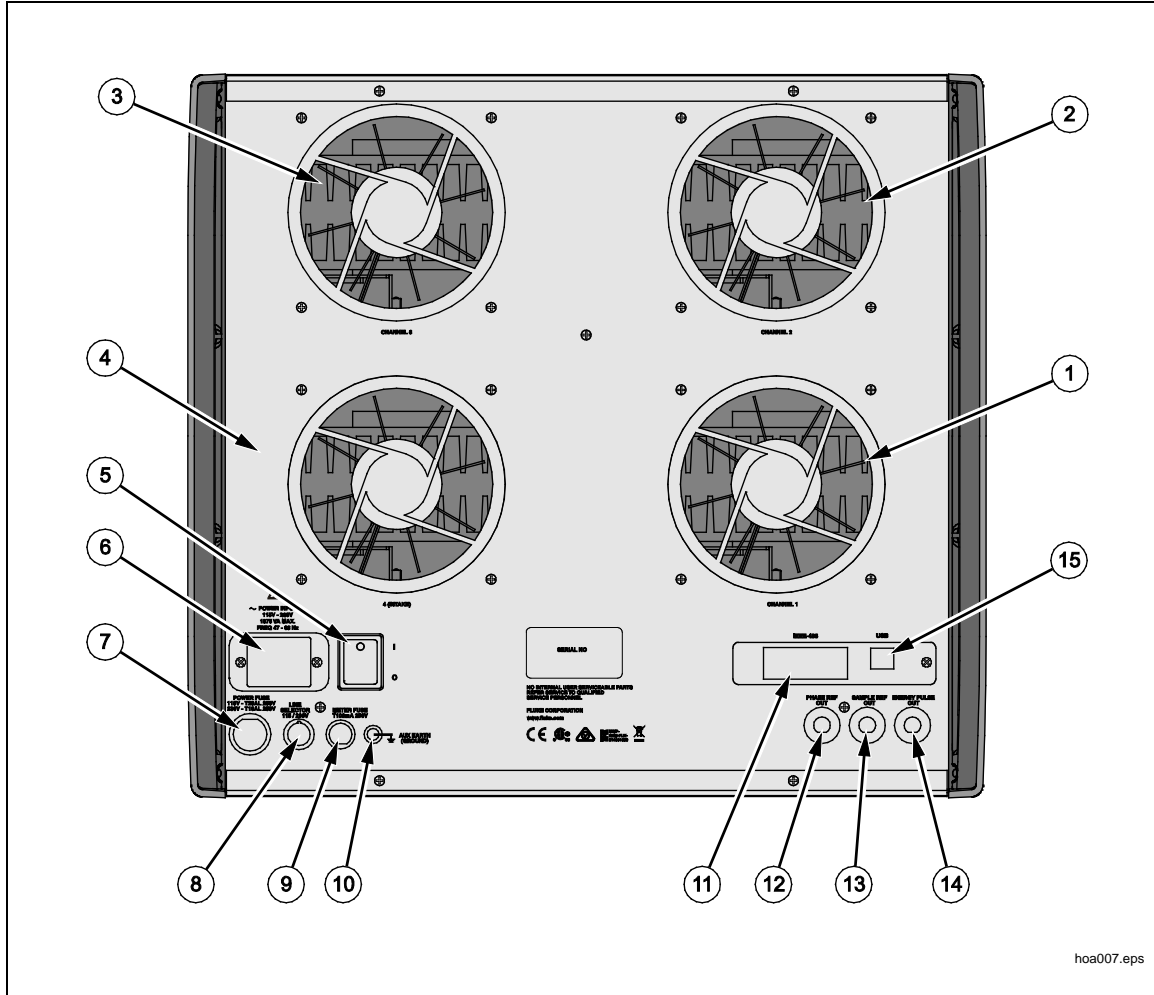

Number	Explanation
①	Forced air ventilation hole #1 (exhaust for Channel 1)
②	Forced air ventilation hole #2 (exhaust for Channel 2)
③	Forced air ventilation hole #3 (exhaust for Channel 3)
④	Forced air ventilation hole #4 (intake)
⑤	Main power switch
⑥	Power line entry
⑦	Power line fuse. Replace with T10AL 250 V for 230 V operation, T20AL 250 V for 115 V operation

Table 3-6. Rear Panel (cont.)

Number	Explanation
⑧	Power line voltage selector (115 V or 230 V settings)
⑨	Fuse for internal multimeter (T100 mA / 250 V)
⑩	Central ground terminal
⑪	GPIB connector
⑫	Phase reference output: Internal reference signal for 0 ° phase. All output channels are synchronized with this signal.
⑬	Sample reference output: Used to trigger an external voltmeter to synchronize sampling measurements with the Instrument outputs, useful to calibrate the Product. Enabled only by remote control.
⑭	Energy pulse output (active with 6003A/E Energy Option): Energy pulse output from the Product. Frequency of pulses is proportional to the power generated by the Product and is defined by the energy meter constant. See <i>Calibrator Setup Menu</i> and <i>Generating Electric Energy</i> in Chapter 4.
⑮	USB connector

## Basic Operation

### Select a Function

After the power is switched on and the initial checks are complete, the Product resets to its reference state:

Function:	Pac Basic (AC Power, Basic mode)
Voltage:	10 V (Channel 1 active)
Current:	1 A (Channel 1 active)
Phase:	0 °
Frequency:	50 Hz

The state of the Product can be changed with the buttons located on the front panel in one of the subsequent ways:

**1. Change of function by pushing one of the direct function buttons**

After you push one of the buttons (**P**, **E**, **V**, **I**) the Product switches to the selected function and sets the last setup parameters for that function. Whenever a function is changed, the Product always goes to the STANDBY position and the output terminals are disconnected. The P, E, V, and I functions have softkeys that are shown in the display.

**2. Connection /disconnection of output terminals**

After **OPER** is pushed, the output terminals of the Product are connected. Only those channels (phases) that are activated are connected. To disconnect terminals, push **STBY**.

**3. Access to the Main Setup menu**

After **MENU** is pushed, the Product shows the basic level of the setup menu. In this menu you can change instrument setting and calibration data. The previous menu is recalled after the **Exit** softkey is pushed.

**Setting the Value of the Output Signal**

*Edit Mode*

Parameters of the output signal can be changed in edit mode. Only parameters shown in blue can be changed. The display can be switched to edit mode in these ways:

- Push a numeric button
- Push **→**
- Push any of the cursor buttons (**↑**, **↓**, **←**, **→**)
- Push the rotary knob

In edit mode, the edited value is highlighted with a blue background. Push **→** to change to the next “blue” parameters. Push the **Exit** softkey to get out of edit mode.

### Entry of the Value with the Numeric Keyboard

Use the numeric keypad to select the necessary value. After the first digit is entered, the input box is shown. The name of edited parameter is in the upper row of the input box. With the softkeys you can enter the new value in different units. See Figure 3-1.

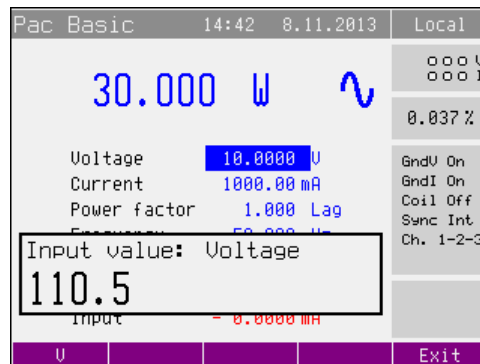

numeric entry.bmp

Figure 3-1. Numeric Entry

- Enter the necessary value.
- After the entry is complete, push the softkey with the requested unit or push **ENTER**. This button inputs the value in basic units (V, A, W).
- The Product sets the new value.
- The value is copied to the appropriate field in the screen and the input box disappears.

### Entry of the Value with the Cursor Buttons

- Push **←**, **→**, **▲**, or **▼**. The display now includes cursor marks which points to the active digit.
- Push **▲** and **▼** to change the active digit. Push **←** and **→** to change the position of the cursor.
- To set the value, push the **Exit** softkey.

### Entry of the Value with the Rotary Knob

- Push the rotary knob. The display now includes a cursor that points to the active digit.
- Turn the rotary knob to change the active digit to another value.
- Push the rotary knob to change to the mode that determines which digit can be changed. ← and → symbols are shown above and below the active digit. The active digit can be changed to another digit by turning the rotary knob.
- To set the value, push the **Exit** softkey.

#### Note

All parameters have limits (high and low). If the entered value is outside these limits, an error message is shown “**Value too large (small)**” and the new value is not accepted.

### Connection/Disconnection of Output Terminals

- After the mains ac power supply is switched on, the output terminals are disconnected in all modes.
- Push **OPER** to connect the output signal to the terminals. The green LED on the OPERATE button is illuminated.
- Push **STBY** to disconnect the output terminals. The orange LED on the STANDBY button is illuminated.

Output terminals are disconnected automatically under these conditions:

- Function mode change
- Output voltage exceeds 100 V. This occurs if the output value is changed from <100 V to a new value >100 V.
- The Product is overloaded
- If some parameters of the output signal are changed. For example, if a harmonic amplitude or phase in P Harmonic is changed, it will cause the Product to go to STANDBY.
- Changing frequency for voltage >280 V.
- Energy counting is finished unless the Maintain Voltage Signal Parameter is set to ON in the Calibrator Setup Menu. In this condition, the green LED on the OPERATE button remains illuminated after the energy test.

#### **Warning**

**To prevent possible electrical shock, fire, or personal injury:**

- **Do not touch any of the connections to the output terminals when any voltage is present.**
- **Do not make connections to the output terminals when any voltage is present. When the Maintain Voltage signal in the Energy mode is activated, the Product continues to output the set voltage levels after completion of the counter and timed energy tests. These voltages can be lethal.**

- The output voltage is changed to be >280 V while the current outputs are floating. This occurs if an output value that is <280 V is changed to a new value >280 V and current outputs are not grounded (GndI Off). The Product disconnects the output terminals and grounds the current terminals. An alert is also shown on the display: **“Current outputs are grounded for voltages over 280 Vac”**.
- The grounding state of current outputs is automatically recovered according to the Setup Menu as soon as the voltage is <280 V. The output terminals are automatically disconnected when changing between ac and dc modes or when the function is changed.

### *Control Sequence when the Output Voltage is >100 V is Selected*

When output voltage >100 V is selected, the information section of the display shows the symbol that informs that a life-threatening voltage is present at the output terminals. If the output terminals are currently connected, they will be disconnected when output voltage >100 V is selected. Push **OPER** to reconnect the output signal to the output terminals. After **OPER** is pushed, the OPERATE LED is illuminated and the information section of the display shows the symbol that notifies the user about the connection of the dangerous output to the output terminals.





## **Multimeter**

The Product includes a built-in multimeter that can measure dc voltage, dc current, and frequency. The measured signal must be connected to the “METER INPUT” terminals. The mA and COM terminals are for current measurements. The V and COM terminals are for voltage and frequency measurements.

### **Warning**

**For safe operation and maintenance of the product, do not exceed the voltage and current limits of the multimeter. Doing so can cause damage to the multimeter and may pose an electrical hazard.**

The multimeter can only measure one parameter at a time. The measurement function should be selected in the Meter Setup menu. To access the Meter Setup menu, push **MENU**.

Push , , , , or use the rotary knob to select one of these functions:

- Voltage – DC voltage range up to 10 V
- Current – DC current range up to 20 mA
- Frequency – frequency range up to 15 kHz

#### *Notes*

*Frequency measurement is possible to a maximum of 15 kHz. The input signal must be within 0.2 V to 5 V. A square wave or pulse shape of the input signal is expected.*

# Chapter 4

## Front-Panel Operation

### Introduction

This chapter describes front-panel operation of the Product. It includes all aspects of Product setup up and configuration. The error codes that may be shown are explained in Chapter 6.

Before the procedures in this chapter are done, familiarize yourself with the front-panel controls, displays, and terminals. These are identified and described in detail in Chapter 3. For information about the Product remote commands, see the *6003A Remote Programmers Manual*.

#### Warning

**The Product can supply lethal voltages. Do not make connections to the output terminals when any voltage is present. Placing the instrument in standby may not be enough to avoid shock hazard. Disconnect the GPIB and USB cables from the Product to prevent remote commands setting unexpected outputs.**

### Power Up

#### Warning

**To prevent electric shock, make sure the Product is grounded as described in Chapter 2.**

#### *Note*

*After you turn on the Product, approximately 20 seconds is necessary to let the Product complete its self-test and initialization procedure.*

### Warmup

Let the Product fully warm up to make sure that it meets the list of specifications in Chapter 1. Warm-up periods are also explained in Chapter 1.

## Set the Language on the Display

The Product has a display that uses either English or Chinese. To set the Product to the preferred language:

1. Push **MENU** to enter the Setup menu.
2. Two softkeys are shown under the graphical display.
3. Push the **Select** softkey to show the English or Chinese choice.
4. Use **▼** and **▲** to highlight English or Chinese.
5. Push the **Select** softkey.
6. Push the **Exit** softkey to get out of the Setup menu.
7. Power off the Product, then on. The display now is in the chosen language.

## Function Selection

After the power is turned on and the initial checks are complete, the Product resets to its reference condition:

Function:	AC Power, Basic mode (Pac Basic)
Power:	10.000 W
Voltage:	10.0000 V
Current:	1000.00 mA
Phase:	0.00 °
Frequency:	50.000 Hz
Active Channels:	Channel 1

The Product state can be changed with the buttons on the front panel:

Push one of the direct function buttons to change the function.

After **P**, **E**, **V**, or **I** are pushed, the Product changes to the selected function and uses the last setup parameters for that function. When a function is changed, the Product always goes to STANDBY, with all of the output terminals disconnected. All functions with direct access (**P**, **E**, **V**, or **I**) have submenus where various basic modes can be selected. Access to the submenu is always with the **Mode** softkey.

Each of the functions (P, E, V, I) has an ac and dc mode that is accessed by the **AC** or **DC**.



## Setup Menu (Main Menu)

The Product lets you set other, less frequently used, parameters. The Setup menu is used to set these parameters. Push **MENU** to open the Setup menu. If output terminals are connected, they will be disconnected and the subsequent display is shown:

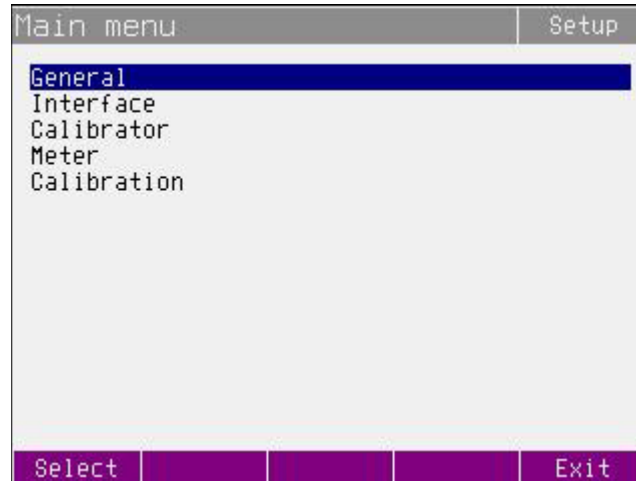

hoa001.jpg

Push **▲**, **▼**, or turn the Rotary Knob to browse the menu options. Push the **Select** softkey or push in the Rotary Knob to select a highlighted item. Push the **Exit** softkey to leave the selected menu level.

New settings are activated once you exit the Main menu and saved when the Product is switched off.

The Main menu shows these items:

- General – general Product settings (language, display, beeper, calibration password, time, date, device information)
- Interface – parameters of the Product remote control
- Calibrator – parameters of signal generation
- Meter – parameters of the multimeter
- Calibration – Product calibration process and data

### General Menu

The submenu contains basic parameters of the display and keypad:

1. **Language** sets the language used on the display. Once selected, the Product must be powered off, then on, for the selected language to take effect.
2. **Volume** sets the beeper volume. Cursor buttons, the Rotary Knob, or numeric keypad can be used to set the range from 0 to 15. Push the **Write** softkey to set the beeper volume and return to the General menu.
2. **Brightness** sets the display brightness. The cursor buttons, Rotary Knob, or numeric keypad can be used to set the value in the range of 0 to 7. Push the **Write** softkey to set the display brightness and return to the General menu.
3. **Beeper** enables or disables the pushed key signal. Possible states are "Beep On" and "Beep Off". Push the **Select** softkey or push in on the Rotary Knob to set the selected state.
4. **Calibration Password** sets the calibration password. The calibration password is a five-digit number which must be entered to access the calibration mode. If the calibration password is set to 0, this information is shown in the General menu. Other values are shown as **Secret**.

The Product prompts for the calibration password (use the numeric keypad and push **Enter**). The calibration password can now be changed. The cursor buttons, Rotary Knob, or numeric keypad let set the value in the range of 0 to 99999. Push the **Write** softkey to set the new password and return to the General menu.

#### Note

*The calibration code should be written down if changed. If the calibration code is lost, the Product will need to be sent to Fluke Calibration.*

5. **Time** sets the real time. This parameter can be changed with the cursor buttons, Rotary Knob, or numeric keypad.
6. **Date** sets the date. This parameter can be changed with the cursor buttons, Rotary Knob, or numeric keypad.
7. **Device Information** shows the Product serial number and software version.

### Interface Menu

The submenu contains these remote control parameters:

1. **Active interface** sets the type of interface used with the Product remote control.

Select either:

- IEEE488
- USB

The Product can be remotely controlled only with the selected interface.

2. **IEEE488 address** sets the Product IEEE488 (GPIB) address. Use the cursor buttons, Rotary Knob, or numeric keypad to set the value in the range of 0 to 30. Push the **Write** softkey to set the address and return to the Interface menu. Address 02 is set by Fluke Calibration as the default.
3. **Baud rate** sets the communication speed used by the USB interface. 1200, 2400, 4800, 9600, 19200, 38400, 76800 or 115200 Baud can be selected.

### Calibrator Menu

Submenu contains parameters that affect the generated signal.

1. **Voltage sources GND** lets you connect the Lo terminals of all voltage channels to GND. In practice, this means that the Lo voltage terminals are grounded to earth via the chassis and mains cord.

By selecting an item from the list:

- GndV Off
- GndV On

the Lo voltage terminal can be grounded or not.

2. **Current sources GND** lets you connect the Lo terminals of all current channels to GND. In practice, this means that the Lo current terminals are grounded to earth via the chassis and mains cord.

3. The Lo current terminal can be grounded or not by selecting an item from the list:

- GndI Off
- GndI On

It is recommended to ground all output channels (GndU On, GndI On). If the meter to be calibrated has Lo terminal grounded, it is recommended to unground the corresponding output of the Product to eliminate ground loops.

4. **Phase unit** sets the unit used for setting the phase between the voltage and current output in the power and energy generation modes.

Units can be selected from this list:

- Deg (°)
- Cos (Lead, Lag)

In the Deg setting, the phase between the voltage and current output is controlled by setting a degree value. In the Cos mode, the phase between voltage and current output is controlled by setting a Power Factor. Note that in the Power extended modes, the phase is controlled only by a degrees setting, to allow more control of phase settings for any given output.

5. **Current coil** sets the Product for usage of the 25 and 50-turn current coils (for clamp ammeters calibration). The coil setting multiplies the output current output display by either 25 times or 50 times depending on the set parameter.

Select the type of connected current coil from the list:

- Coil Off
- Coil x25
- Coil x50

When a current output is set, the display shows either 25 or 50 times the actual value.

6. **Synchronization** defines synchronization of the output signal.

The type of frequency synchronization can be selected from the list:

- Internal (internal synchronization)
- Power line (synchronization to the mains power supply)
- External IN2 (synchronization to the active signal on input 2)

When Power Line is selected, outputs are limited to the mains frequency.

*Note*

*The external synchronized signal may have larger distortion of the outputs than the internal synchronized signal because of additional timing errors.*

7. **Active channels (Pac, Eac)** sets the number of controlled channels in the three-phase configuration. This parameter is valid only for Pac Basic and Eac Basic function modes.

The number of active channels can be selected from the list:

- 1 (output is from Channel 1 only)
- 1-2 (output from Channel 1 and Channel 2)
- 1-2-3 (output from all three channels)

8. **Harmonic components** can be entered in two ways:

- % of RMS value

RMS value is constant (is not changed by changing the harmonic component value). A new RMS value changes the amplitude of all harmonic components.

- % of fundamental

The fundamental value is constant (is not changed by changing the harmonic component value). The RMS value is changed by entering the new harmonic component value.

*Note*

*Harmonic features are available only in the 6003A/PQ Power Quality Option.*

9. The **Energy** submenu contains parameters that affect energy generation:

- **Energy units** sets the unit used for energy.

By selecting an item from the list, Ws and Wh unit can be selected.

- **Energy – output** contains parameters to set the energy pulse output (BNC connector on the rear panel).

- **Internal pull-up** lets you connect the internal pull-up resistor (150  $\Omega$ ) to the Energy pulse output.
- The **Output constant** contains parameters to define the constant of Energy pulse output.
  - The **Value** parameter sets number of pulses (expressed as “i”) for the selected unit (pulses generated on Energy pulse output on the rear panel BNC).
  - The **Unit** parameter sets the unit of the Output constant value (pulses generated on Energy pulse output on the rear panel BNC).

- **Energy – input IN1** contains parameters to set the energy pulse input IN1 (BNC connector on the front panel):
- **Internal pull-up** this parameter lets you connect the internal pull-up resistor (150  $\Omega$  or 1 k $\Omega$ ) to the Energy pulse input. 150  $\Omega$  should be used for higher frequency inputs, up to 1 MHz.
- **Input filter** this parameter lets you add an input filter for contact debouncing. The input frequency with the input filter is limited to 400 Hz.
- **Maintain Voltage Signal** this parameter keeps the voltage signal on after the completion of an energy test in energy counting modes (Packet / Counter / Timer). This lets the Product continue to power up the Unit Under Test (UUT), so that the UUT does not turn off between tests. After completion of an energy test, the green LED on the Operate button stays on. To start another test, push the Operate button.

### **Warning**

**When the Maintain Voltage signal in the Energy mode is activated, the Product continues to output the set voltage levels after completion of the Packet, Counter and Timed Energy Tests, and when the Control method is changed. These voltages can be lethal. Do not touch any of the connections to the output terminals when any voltage is present. Do not make connections to the output terminals when any voltage is present.**

#### *Note*

*Energy features are available only with the 6003A/E Energy Option.*

10. The **Dip-Swell** submenu has parameters that affect the Dip-Swell generation:
  - **Dip-Swell repetition** sets the repetition of Dip/Swell signal in Power Dip/Swell mode.  
Select one of these items to control number of Dip/Swell occurrences:
    - One Shot (without repetition)
    - Repeat (with repetition)
 If Repeat is selected, the Dip/Swell signal is generated after trigger repeatedly until the output terminals are disconnected by pushing .

- **Dip-Swell synchronization** sets the synchronization of the Dip/Swell shape with the internal phase 0 °.

Synchronization can be selected from the list:

- Sync Off
- Sync On

If Sync Off is selected, Dip/Swell generation starts immediately after trigger. If Sync On is selected, Dip/Swell is synchronized with the internal phase of 0 °.

- **Dip-Swell ext. trigger** enables external triggering in the Power Dip/Swell mode.

External-trigger can be selected from the list:

- Input Off
- Input IN2

If Input Off is selected, Dip/Swell generation can be started only internally (**Trigger** softkey or remote control). If Input IN2 is selected, Dip/Swell generation can be started internally or by the falling edge being applied to the IN2 input. The input must remain low for 10 μs after the falling edge to be recognized properly.

*Note*

*Dip-swell features are only available in the 6003A/PQ Power Quality Option.*

11. The **Voltage From Current** submenu contains parameters that affect the Voltage From Current function. This function is available only in Pac and Pdc Extended modes.
  - **State** - The current output in Pac and Pdc Extended modes can be configured to output a voltage by setting the “Enable” state.
  - The **Equivalence Factor** defines the ratio between simulated current value and generated voltage. This equivalence factor is used for converting the voltage output to an equivalent current. The factor is expressed in V/A and has a range of 0.000002 V/A to 10 V/A.

**Meter Menu**

The **Meter** submenu contains parameters that can be measured by the Product.

**Function** sets the internal multimeter measure function.

To select measurements, choose an item from the list:

- Voltage (dc voltage 0-12 V)
- Current (dc current 0-25 mA)
- Frequency (Frequency 1 Hz-15 kHz)

Current is measured across the mA and COM terminals. Voltage or frequency is measured across the V and COM terminals.

### Calibration Menu

The calibration password is necessary to access the Calibration Menu. The default calibration password is "0". For more about calibration, see Chapter 6.

### Activate the Output Terminals

After the Product is switched on, the output terminals are disconnected from the voltage and current amplifiers.

To activate the output terminals:

1. Push **OPER** to connect the active output signal to the terminals. The green LED in the Operate button illuminates.
2. Push **STBY** to disconnect the output terminals. The amber LED in the Standby button illuminates.

The output terminals are disconnected automatically under these conditions:

- **RESET** is activated.
- If the function selection is changed.
- If the Product changes between ac and dc modes.
- If the output voltage exceeds 100 V. See below - *Control Sequence when Output Voltage over 100 V is Selected*.
- If the Product is overloaded.
- If some parameters of the output signal (Harmonic, etc.) are changed.
- If the frequency for voltages >280 V is changed.
- Energy counting is finished unless the Maintain Voltage Signal feature is in the ON setting. In this case, **OPER** is still illuminated green, with the voltage output channels on, but with the current channels off. See the *Energy* section for more information.



- If the output voltage exceeds 280 V while the current outputs are floating. This occurs if you change the output value to a new value >280 V and the current outputs are not grounded (GndI Off). The Product disconnects all output terminals, grounds the current terminals, and shows the subsequent message:

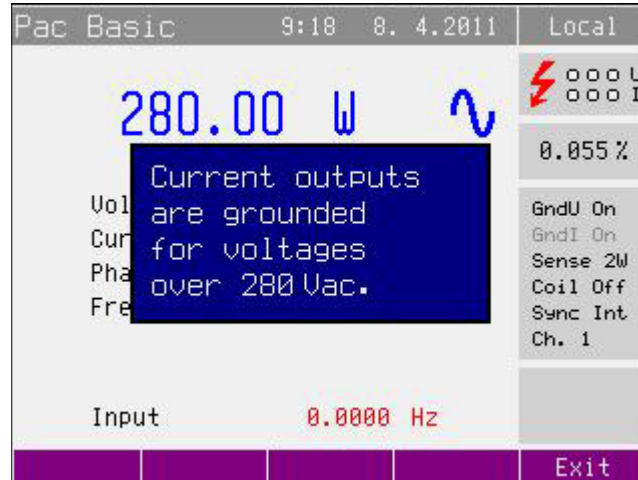

hoa002.jpg

The grounding state of the current outputs will be automatically recovered according to the Setup Menu as soon as the voltage drops to <280 V.

### **Control Sequence when Output Voltage >100 V**

When output voltage >100 V is selected, the information section of the display shows the symbol that informs a life-threatening voltage will be present at the output terminals (⚡). If the output terminals are currently connected, they will be disconnected when output voltage >100 V is selected. **OPER** must be pushed to reconnect the output signal to the output terminals. After **OPER** is pushed, the green operate LED is illuminated and the display shows the symbol that notifies you about the dangerous output signal at the output terminals.

Once the output voltage is at  $\geq 100$  V or greater, subsequent changes to the output voltage will not disconnect the output terminals.

Voltages <100 V and frequency can be set without the outputs being disconnected.

## Set the Output

### Edit mode

Parameters of the output signal can be changed in Edit mode. Only parameters shown in blue can be changed. The display can be changed to Edit mode in different ways:

- Push any numeric button
- Push **→** (in the center of the four-way cursors buttons)
- Push any of the cursor buttons
- Push the Rotary Knob

In Edit mode, the changeable value is highlighted with a blue background. Push **→** to highlight other parameters. Edit mode is finished when the **Exit** softkey is pushed.

### Enter a Value with the Numeric Keypad

To enter a value with the numeric keypad:

1. Use the numeric keypad to select a value. After the first digit is entered, an input box is shown. In the upper row of the input box is the name of the edited parameter. With the softkeys, you can enter the new value in different units.
2. Enter the new value.
3. After the entry is complete, push the softkey with the requested unit or push **ENTER**. **ENTER** inputs the value in basic units (V,A,W,...).

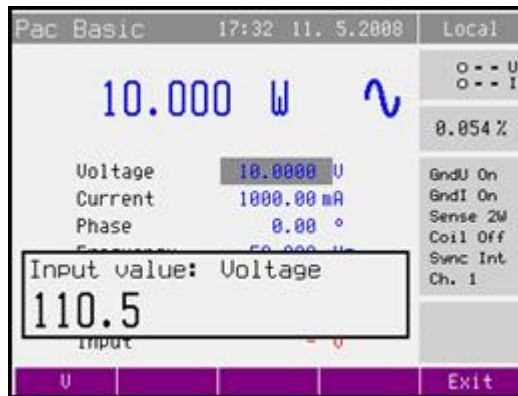





hoa119.jpg

4. The value is copied to the appropriate field in the screen and the input box disappears.



### Enter a Value with the Cursor Buttons

To enter a value with the cursor buttons:

1. Push the cursor buttons. The display now includes cursor marks that point to the active digit.
2.  and  can be used to change the active digit. ,  can be used to change the position of the cursor marks.
3. To set the output value, push the **Exit** softkey.

### Enter a Value with the Rotary Knob

To enter a value with the Rotary Knob:

1. Push the Rotary Knob. The display now includes cursor marks that point to the active digit.
2. Turn the knob to change the active digit.
3. Push the Rotary Knob to change to the mode that allows you to change the value of the active digit.  and  symbols are shown above and below the active digit. The active digit is changed by turning the knob.
4. Turn the knob to change the position of the active digit.
5. To get to the default screen, push the **Exit** softkey. All values can be set with the buttons or the Rotary Knob.

#### Note

*All parameters have limits (high and low). If the entered value is outside these limits, an error message is shown (“Value too large or small”) and the new value is not accepted.*

## Generating Electric Power

The Product can generate precise electric power. The Power function provides output voltage at the VOLTAGE OUTPUT HI – LO terminals and output current at the CURRENT OUTPUT HI – LO terminals.

Power setting range:	0.008 VA to 18 kVA (each channel)
Voltage setting range:	1 to 600 V ac, 1 to 280 V dc
Current setting range:	8 mA to 30 A (each channel) or 90 mA to 90 A (High I mode, one channel)
Power factor setting range:	-1 to +1 (phase 0 to +359.99 °)
Frequency setting range:	DC, 15 Hz to 1 kHz

### Control in the Power Mode

- Push **P** to set the Product to the Power mode. The display shows the subsequent data:
  - Value of set power in selected unit of measurement (VA, W, VAR)
  - Voltage at VOLTAGE OUTPUT HI-LO terminals
  - Current at CURRENT OUTPUT HI-LO terminals
  - Power factor or the phase shift between the voltage and current in  $^{\circ}$ .
  - Frequency, if ac power is selected
  - Uncertainty of set power
  - Input, mA, volts, or frequency, depending on multimeter setting.
- Set the new value of power with the numeric keypad, Rotary Knob, or cursor buttons. Output power is not yet connected to the output terminals.
- Connect the UUT to the VOLTAGE OUTPUT HI-LO and CURRENT OUTPUT HI-LO terminals or short the CURRENT OUTPUT HI-LO terminals if no current is to be supplied to the UUT.
- Push **OPER**. The green LED is lit on **OPER** to indicate the connection of simulated electrical power to the output terminals. Connected terminals are also shown in the “Outputs state” window as green circles. The green LEDs above each of the active output terminals are also lit. See the Power mode screen below.

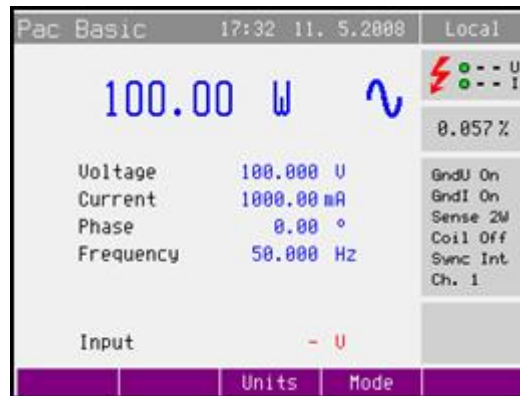

hoa120.jpg

**Power Factor Polarity (Lead/Lag Softkey)**

In cases where phase shift between voltage and current is shown as power factor, you can change its polarity with the **Lead/Lag** softkey. The Lead polarity represents a capacitive load (current before voltage). The Lag polarity represents an inductive load (voltage before current).

**Power Units (Units Softkey)**

The Product shows ac power in one of three ways:

- Apparent power in VA
- Active power in W
- Reactive power in VAR

Use the **Units** softkey to open the units selection menu. Select the necessary unit with the cursor buttons or the Rotary Knob. Push the Rotary Knob or the **Select** softkey to confirm the selection. The value of displayed power is recalculated together with the new units selection. DC power can be shown only in W.

The Product shows the phase relation of output voltage and current as power factor (-1 to +1) or as phase shift in degrees (0 ° to 359.99 °). The Main menu is used to change the method that shows the phase relation.

**Power Modes (Mode Softkey)**

Output power can be generated in different power modes. For ac power modes, see Table 4-1. For dc power modes, see Table 4-2.

**Table 4-1. AC Power Modes**

Mode	Name	Description
Basic	Pac Basic	AC power basic mode. Phase shift between each channels output voltages are fixed (120 ° and 240 °). All parameters are the same for all channels. The number of active channels can be defined in the Main menu (1, 2, or 3).
High I	Pac High I	In this mode, current outputs of all channels are connected in parallel (with the High Current Adapter). Current range is increased three times. Only the Channel 1 voltage output is active.
Extended	Pac Extended	Parameters for all Product outputs (3x voltage, 3x current) can be set independently in this mode. For each output, you can define amplitude (V or A) and phase shift (°). Phase shift is relative to the internal reference and is specified in degrees.
Harmonic	P Harmonic	This mode is used to generate harmonic signals composed of a maximum of 63 harmonic components. All components can be defined independently for all outputs (3x voltage, 3x current). This mode allows modulation by a sine or square signal. <sup>[1]</sup>
Interharmonic	P Iharmonic	This mode is used to generate an interharmonic signal. One interharmonic component can be added independently to all outputs (3x voltage, 3x current). <sup>[1]</sup>
[1] The output amplitude and phase specifications are relaxed compared to the non-harmonic and non-interharmonic modes.		

**Table 4-2. DC Power Modes**

Mode	Name	Description
Basic	Pdc Basic	DC power basic mode. Only the first channel (1) is controlled in this mode.
High I	Pdc High I	In this mode, current outputs of all channels are connected in parallel (with the High Current Adapter). The current range is increased 3x.
Extended	Pdc Extended	Parameters for all Product outputs (3x voltage, 3x current) can be set independently in this mode.

Use the **Mode** softkey to open the mode selection menu. Select the necessary mode with the cursor buttons or the Rotary Knob. Push the Rotary Knob or the **Select** softkey to confirm the selection. Output terminals are disconnected if a new mode is selected.

**Setting the Power in Modes Pdc Basic and Pac Basic**

The Product has four methods to set the value of generated power. These methods are explained below.

**1. Set the main power value**

The main value can be changed with the numeric keypad, the cursor keys or the Rotary Knob. The power is changed by changing the current output of the Product.

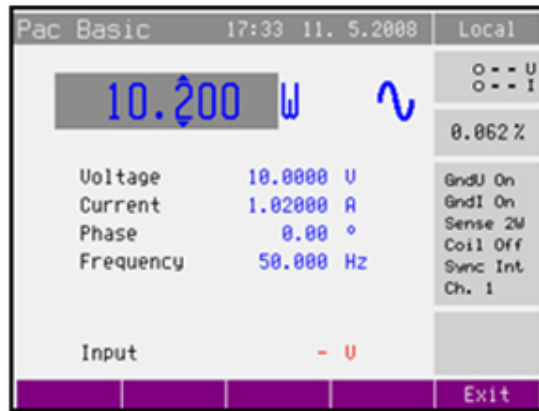
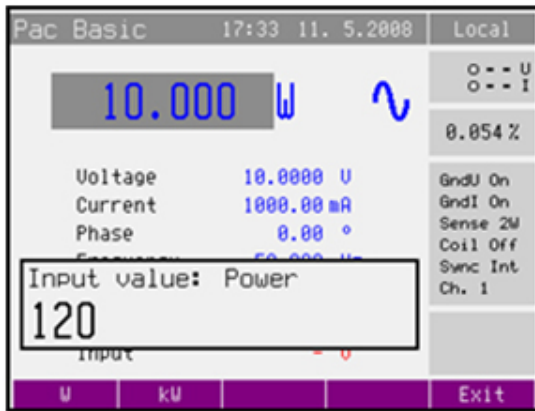

hoa121.jpg

**2. Set the voltage**

- Change the voltage to change the main power value.
- Repeatedly push **→** until the voltage value is shown in edit mode (blue background).
- The value can be set with the numeric keypad and confirmed by the **V** softkey. The value can also be set with the cursor buttons or Rotary Knob.
- The main power value is recalculated with the new set voltage and the existing current and power factor setting.

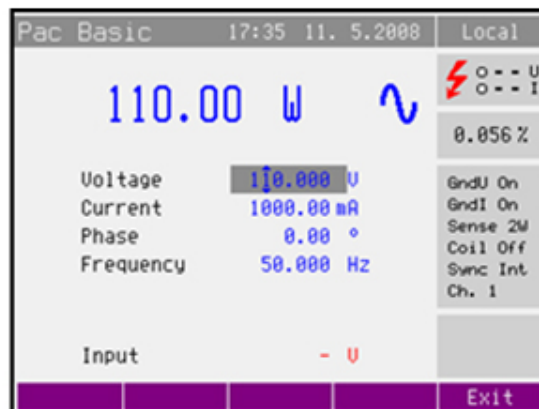
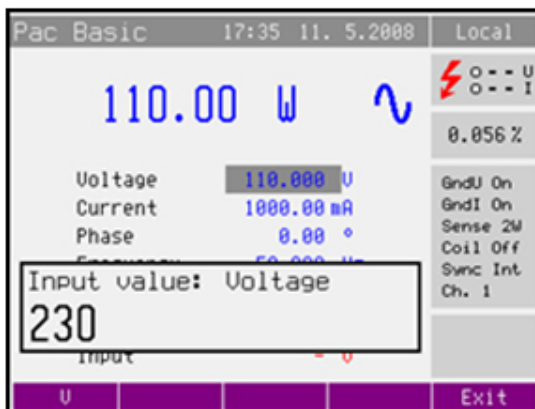

hoa122.jpg

### 3. Set the Current

- Change the current to change the main power value.
- Repeatedly push **→** until the current value is shown in edit mode (blue background).
- The value can be set with the numeric keypad and confirmed with the **mA** or **A** softkey. The value can also be set with the cursor buttons or the Rotary Knob.
- The main power value is recalculated with the new set current and existing voltage and power factor setting.

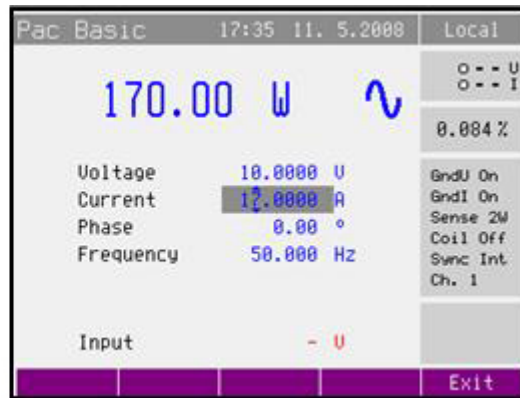
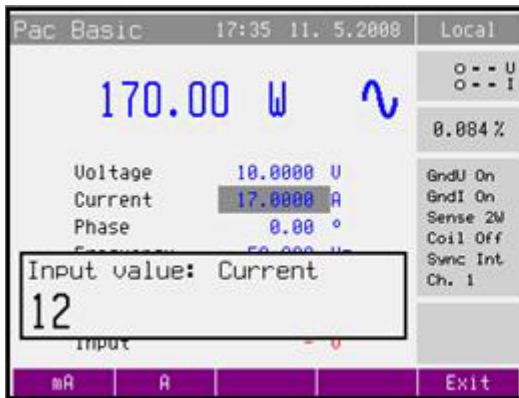

hoa115.jpg

### 4. Set the Power Factor (AC Power Only)

- If W or Var is shown, the main power value can be changed by changing the power factor. A change to the power factor does not change the output apparent power.
- Repeatedly push **→** until the power factor (phase) value is shown in edit mode (blue background).
- The value can be set with the numeric keypad and confirmed with the **Lead** or **Lag** softkey. The value can also be set with the cursor buttons or Rotary Knob.

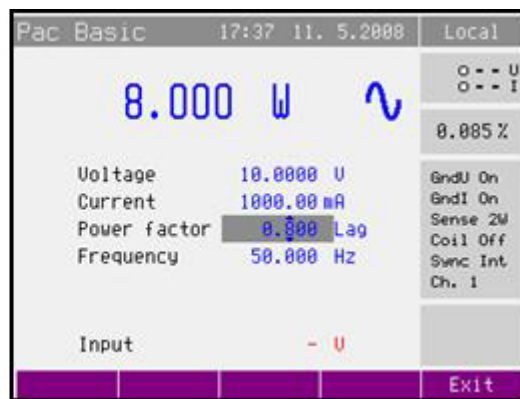
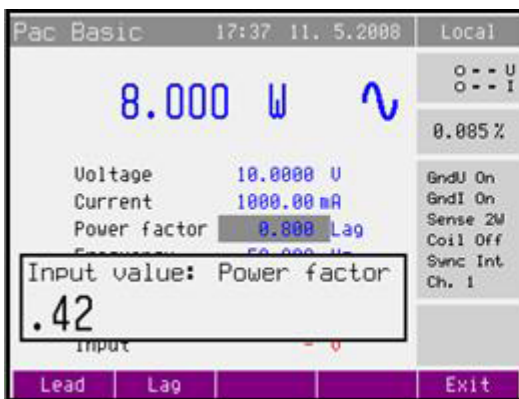

hoa116.jpg

- Main power value is recalculated with the new set power factor and existing current and voltage setting. The calculation is only made if active or reactive power is shown.



**Set the Power in Pdc High I and Pac High I Modes**

In the Pdc High I and Pac High I modes, the current outputs of all channels are connected in parallel with an optional adapter. The current range is increased 3X, up to 90 A.

The voltage terminal on channel 1 can only be used in high current modes.

The power setting is the same as in modes Pdc Basic and Pac Basic.

**Set the Power in Pdc Extended and Pac Extended Modes**

The Pdc and Pac Extended modes let you independently set parameters for all of the Product outputs (3x voltage, 3x current). For each output you can define amplitude (V or A) and phase shift (°). Phase shift is relative to the internal reference.

The main power value shows summed power calculated as the sum of power of all connected channels. It is not possible to change this value directly. The color of this value is black.

Each of the Product outputs (V1, V2, V3, I1, I2, I3) is shown as a tab. The V1 tab is active after you select the Extended mode. Next, folders are activated by repeatedly pushing the **Channel** softkey.

Push the **On/Off** softkey to enable or disable the active output. Only enabled outputs will be connected after the “Operate” button is pushed. Enabled outputs are highlighted by a blue rectangle above the output name.

The display shows a Power state where V1 and I1 are active. The “V1” in the blue box indicates V1 parameters can be changed in this folder.

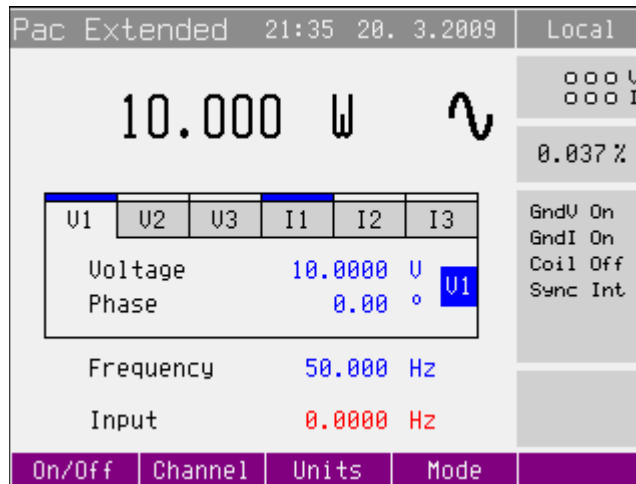

chap 4-16.bmp

### Set the Amplitude of Voltage or Current

- Change the amplitude of the voltage or current to change the main power value.
- Repeatedly push **↔** until the voltage (current) value is shown in edit mode (blue background).
- The value can be set with the numeric keypad and confirmed by the **V** (**mA, A**) softkey. The value can also be set with the cursor buttons or Rotary Knob.

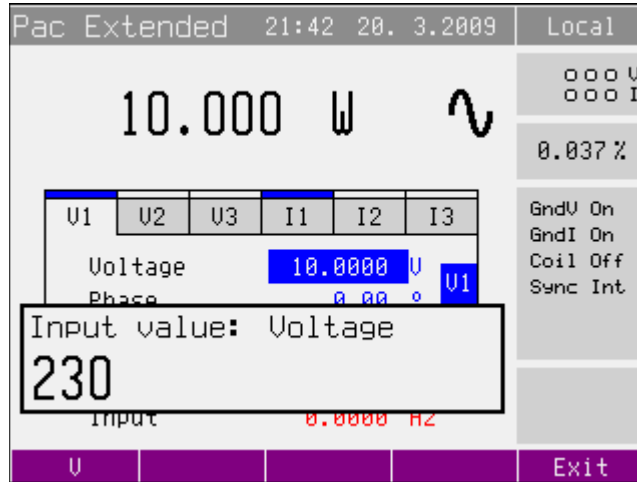

chap 4-17 1.bmp

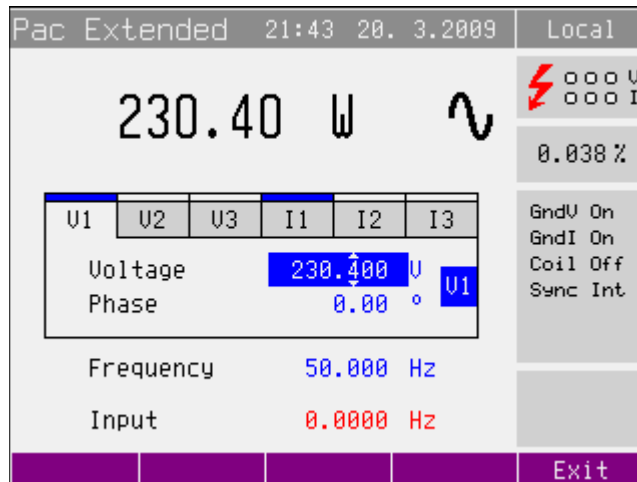

chap 4-17 2.bmp

- Main power value is recalculated with the new amplitude.
- Push the **Channel** softkey to move to the next channel and change the parameters.

**Set the Phase (AC Power Only)**

- If W or VAR is shown, change the phase shift to change the main power value. Change of phase does not change the output apparent power.
- Repeatedly push **↔** until the phase value is shown in edit mode (blue background).
- The value can be set with the numeric keypad and confirmed by pushing the **°** softkey. The value can also be set with the cursor buttons or Rotary Knob.

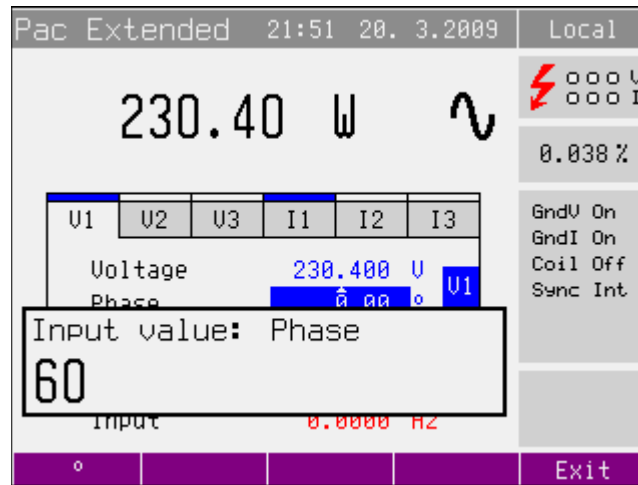

chap 4-17 3.bmp

- The main power value is recalculated with the new set phase and existing current and voltage setting. The calculation is only made if active or reactive power is shown.
- Next, folders (outputs) are activated by repeatedly pushing the **Channel** softkey.

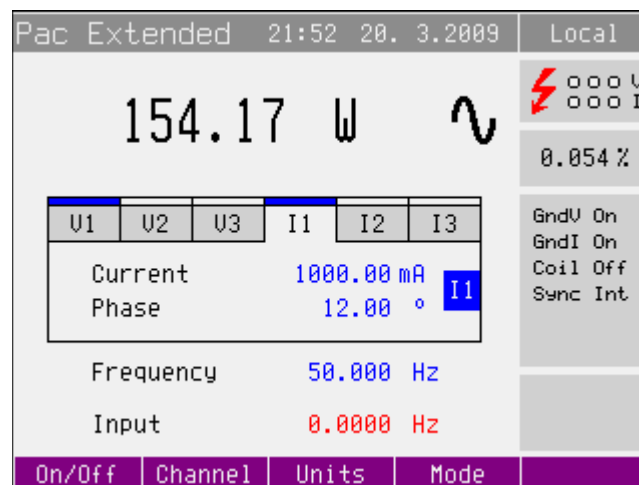

chap 4-17 4.bmp

### Set the Frequency (AC Power Only)

- Repeatedly push **←** until the frequency value is shown in edit mode (blue background).
- The value can be set with the numeric keypad and confirmed by pushing the **Hz** softkey. The value can also be set with the cursor buttons or Rotary Knob.

### Power Quality Modes (Available with 6003A/PQ Power Quality Option only)

The subsequent modes are available only with the 6003A/PQ Power Quality Option installed.

#### Set the Power in P Harmonic Mode

Use Harmonic mode to generate a harmonic signal composed of a maximum of 63 harmonic components. All components can be defined independently for all outputs (3x voltage, 3x current). This mode allows modulation by a sine or square signal.

Each Product output (V1, V2, V3, I1, I2, I3) is shown as a tab. The V1 tab is active after you select the Harmonic mode. Next, tabs are activated by repeatedly pushing the **Channel** softkey.

Push the **On/Off** softkey to enable or disable the active output. Only enabled outputs will be connected after you push **OPER**. Enabled outputs are highlighted by a blue rectangle above the output name.

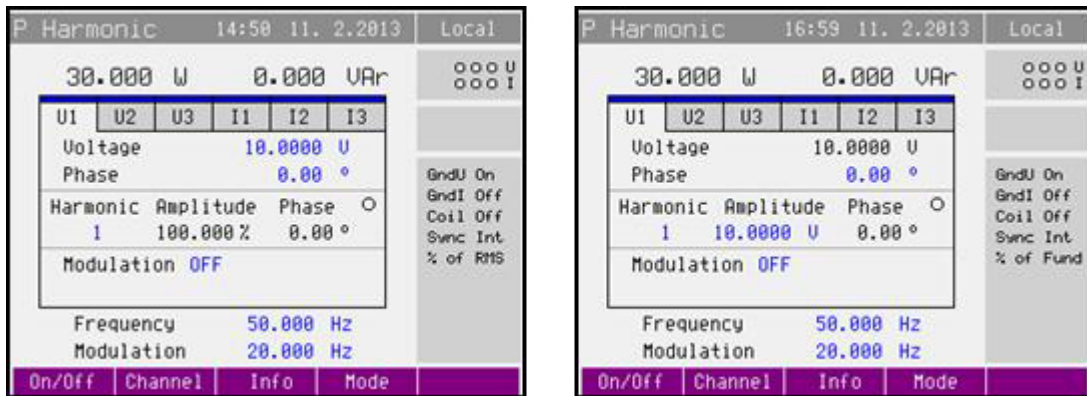

hoa117.jpg

Push the **Info** softkey to show an informational window. The range for all outputs is shown. Range is important for uncertainty calculation because the uncertainty is not shown in P Harmonic mode.

Internal multimeter is not available in the P Harmonic mode.

### Set the Amplitude of Voltage or Current

Harmonic amplitude can be defined as a % of the overall RMS value, or as a % of the fundamental value. This selection is made in the Calibrator Menu, "Harmonic Components".

- Repeatedly push **↔** until the voltage or current value is shown in edit mode (blue background).
- The value can be set with the numeric keypad and confirmed by pushing the **V**, **mA**, or **A** softkey. The value can also be set with the cursor buttons or Rotary Knob.
- Output terminals are disconnected if a new amplitude is set.
- Push the **Channel** softkey to edit the parameters of each output.

### Set the Phase

- Repeatedly push **↔** until the phase value is shown in edit mode (blue background).
- The value can be set with the numeric keypad and confirmed by pushing the **°** softkey. The value can also be set with the cursor buttons or Rotary Knob.
- Push the **Channel** softkey to edit the parameters of each output.

### Set the Amplitude and Phase of Harmonic Components

- Select the necessary harmonic component (1-63). Repeatedly push **↔** until Harmonic is shown in edit mode (blue background).
- The number of a harmonic component can be set with the numeric keypad and confirmed by pushing **ENTER**. The value can also be set with the cursor buttons or Rotary Knob. The number of the amplitude and phase of this harmonic component is shown next to the harmonic component number.
- Push **↔** to show the amplitude of the selected harmonic component in edit mode (blue background). This is not valid for the fundamental harmonic (1. harmonic component) if the harmonic components are defined as % of RMS. The amplitude of the fundamental harmonic is calculated with the RMS value of the output signal and amplitudes of harmonic components, 2-63 in this case.
- The amplitude of harmonic components 2-63 can be set with the numeric keypad and confirmed by pushing the **%** softkey. The value can also be set with the cursor buttons or Rotary Knob. Amplitude can be set in the range of 0 to 30.000 %. Amplitude is expressed as % of RMS value or % of the Fundamental harmonic.
- The phase of harmonic components 2-63 can be set with the numeric keypad and confirmed by pushing the **°** softkey. The value can also be set with the cursor buttons or Rotary Knob. Phase can be set from 0.00 ° to 359.99 °.

- The **Harm+** and **Harm-** softkeys facilitate moving between harmonic components.
- The **Ampl.** and **Phase** softkeys change between Amplitude and Phase edit mode for the selected harmonic component.
- All harmonic components (2-63) can be cleared by pushing the **Clear** softkey. The **Clear** softkey is available if the fundamental harmonic is shown.
- Output terminals are disconnected if a new amplitude is set.

### Set the Modulation

In Power Harmonics mode, modulation is normally switched off. Repeatedly push **→** until the Modulation parameter shows in edit mode (blue background). Shape can be selected with the **SINE**, **RECT**, or **OFF** softkeys. Duty cycle (1 to 99 %) is available for a rectangular modulation signal.

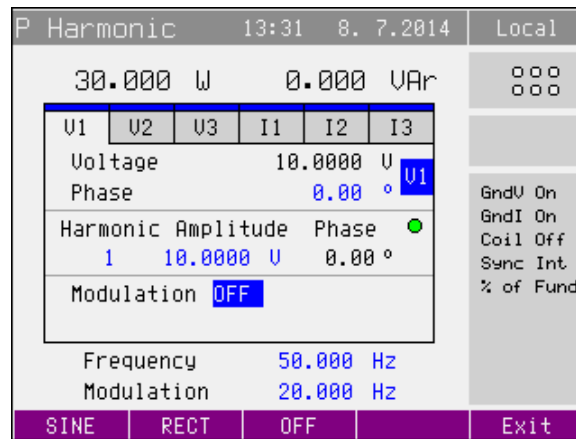

Chap4-23 2.bmp

- All harmonic components are modulated by the modulation signal.
- The frequency of the modulation signal is determined by the “Modulation” parameter. The amplitude of the modulated output will swing between (Output + modulation %) and (Output - modulation %).

#### Note

*The Fluke 6100 Series Electrical Power Standards define modulation as  $\Delta V/V\%$ , where its output signal swings between (output setting +  $\frac{1}{2} \Delta V/V\%$ ) and (output setting -  $\frac{1}{2} \Delta V/V\%$ ). To get the same modulation as the 6100 Series, set the 6003A modulation to  $\frac{1}{2}$  the  $\Delta V/V\%$  setting of the 6100.*

**Set the Power in P Interharmonic Mode**

Interharmonic mode is used to generate a signal composed of the fundamental harmonic and one interharmonic component. All parameters can be defined independently for all outputs (3x voltage, 3x current).

Each output of the Product (V1, V2, V3, I1, I2, I3) is shown as a folder as in the figure below. The folder V1 is active after you select the Interharmonic mode. Next, folders are activated by repeatedly pushing the **Channel** softkey.

Pushing the **On/Off** softkey disables (enables) the active output. Only enabled outputs will be connected after **OPER** is pushed. Enabled outputs are highlighted by blue rectangle above the output name.

Push the **Info** softkey to show the information window. The range used is shown for every output. The value of the range used is important for uncertainty calculation because the uncertainty is not shown in P Interharmonic mode.

Internal multimeter is not available in P Interharmonic mode.

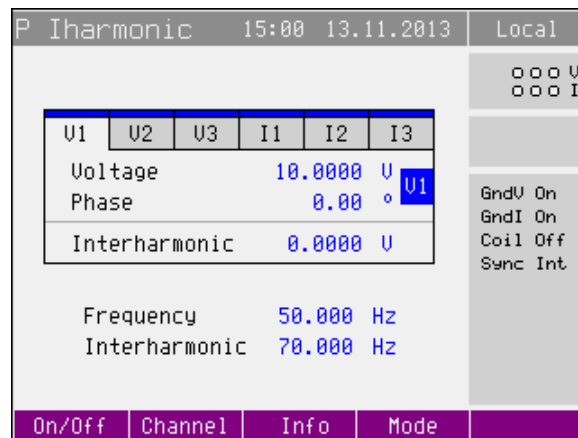

Chap4-23.bmp

**Set the Amplitude (RMS value) of Voltage (Current)**

- Repeatedly push **↔** until the voltage (current) value is shown in edit mode (blue background).
- The value can be set with the numeric keypad and confirmed with the push of the **V (mA, A)** softkey. The value can also be set with the cursor buttons or Rotary Knob.
- Output terminals are disconnected if new amplitude is set.
- Push the **Channel** softkey to edit the parameters of each output.

**Set the Phase**

- Repeatedly push **↔** until the phase value is shown in edit mode (blue background).
- The value can be set with the numeric keypad and confirmed by pushing the **°** softkey. The value can also be set with the cursor buttons or Rotary Knob.
- Push the **Channel** softkey to edit the parameters of each output.

**Set the Amplitude (RMS Value) of the Interharmonic Component**

- Repeatedly push **↔** until the interharmonic value is shown in edit mode (blue background).
- The value can be set with the numeric keypad and confirmed by pushing the **V (mA, A)** softkey. The value can also be set with the cursor buttons or Rotary Knob.
- The output terminals are disconnected if a new amplitude is set.
- Push the **Channel** softkey to edit the parameters of each output.

**Set the Power in P Dip/Swell Mode**

This mode is used to generate dips or swells on the output signal. All parameters can be defined independently for all outputs (3x voltage, 3x current).

Each of the Product outputs (V1, V2, V3, I1, I2, I3) is shown as a folder. The V1 tab is active and the Dip/Swell mode is selected.

Repeatedly push the **Channel** softkey to edit the parameters of each output.

Push the **On/Off** softkey to disable or enable the active output. Only enabled outputs will be connected after you push **OPER**. Enabled outputs are highlighted by a blue rectangle above the output name.

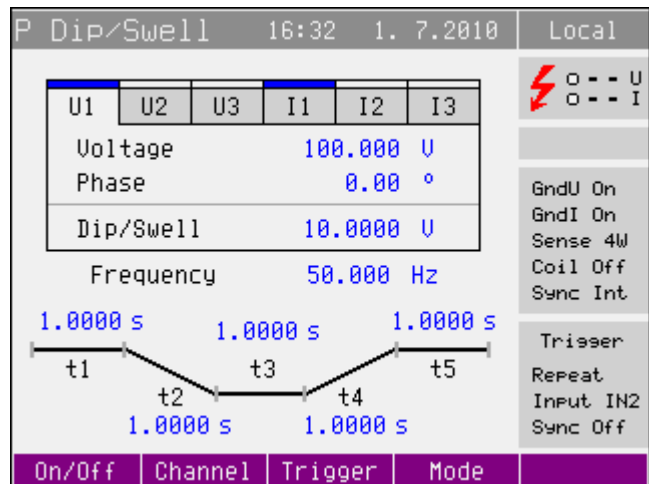

chap 4-25.bmp



The **Trigger** softkey starts the generation of the Dip/Swell shape. Generation can also be started (triggered) from input IN2. Dip/Swell shape is divided into five time periods and the length of these periods can be changed. The periods are shown in the box.

- t1 Voltage (Current) amplitude is generated during period t1 after trigger
- t2 Amplitude is being changed to Dip/Swell amplitude
- t3 Dip/Swell amplitude is generated
- t4 Amplitude is being changed to Voltage (Current) amplitude
- t5 Voltage (Current) amplitude is generated

The subsequent Dip/Swell parameters are controlled in the Calibrator Setup menu:

**Dip/Swell repetition**

- One Shot Trigger starts generation of one Dip/Swell signal
- Repeat Trigger starts repeated generation of Dip/Swell signals

**Dip/Swell synchronization**

- Sync Off Dip/Swell signal starts immediately after trigger
- Sync On Start of Dip/Swell signal is synchronized with the phase 0 °

**Dip/Swell ext. trigger**

- Input Off Dip/Swell can be triggered only internally (keyboard or remote control)
- Input IN2 Dip/Swell can be triggered internally or by external TTL falling edge signal applied to input IN2

Internal multimeter is not available in P Dip/Swell mode.

**Set the Amplitude (RMS value) of Voltage or Current**

- Repeatedly push **↔** until the voltage or current value is shown in edit mode (blue background).
- The value can be set with the numeric keypad and confirmed by pushing the **V** or **mA**, **A** softkeys. The value can also be set using cursor buttons or Rotary Knob.
- Output terminals are disconnected if a new amplitude is set.
- Push the **Channel** softkey to edit the parameters of each output.

**Set the Phase**

- Repeatedly push **↔** until the phase value is shown in edit mode (blue background).
- The value can be set with the numeric keypad and confirmed by pushing the ° softkey. The value can also be set with the cursor buttons or Rotary Knob.
- Push the **Channel** softkey to edit the parameters of each output.

### **Set the Amplitude (RMS Value) of Dip/Swell**

- Repeatedly push **↔** until the Dip/Swell value is shown in edit mode (blue background).
- The value can be set with the numeric keypad and confirmed by pushing the **V (mA, A)** softkeys. The value can also be set with the cursor buttons or Rotary Knob.
- Output terminals are disconnected if a new amplitude is set.
- Push the **Channel** softkey to edit the parameters of each output.

### **Set Dip/Swell Time Periods**

- Repeatedly push **↔** until the required time period (t1, t2, t3, t4 or t5) is shown in edit mode (blue background).
- The value can be set with the numeric keypad and confirmed by pushing the **ms (s)** softkey. The value can also be set with the cursor buttons or Rotary Knob.
- Output terminals are disconnected if a new time is set.
- Push the **Channel** softkey to edit the parameters of each output.

### **Generate Electric Energy (Available with 6003A/E Energy Option installed)**

The Product can generate exact values of electric energy. The energy function modes provide output voltage at VOLTAGE OUTPUT HI – LO terminals and output current at CURRENT OUTPUT HI – LO terminals.

Power setting range:	0.008 VA to 18 kVA (each channel)
Voltage setting range:	1 V ac to 600 V ac, 1 V dc to 280 V dc
Current setting range:	8 mA to 30 A (each channel), 90 mA to 90 A (High I mode)
Power factor setting range:	-1 to +1 (phase 0 ° to +359.99 °)
Time setting range:	1 s to 10000 s
Frequency setting range:	DC, 15 Hz to 1 kHz

### **Energy Pulse Output**

Energy pulse output is located on the rear panel (BNC connector is in the right bottom corner). The frequency of pulses is proportional to the energy generated by the Product and is defined by the energy meter constant ( this can be changed in the main setup menu).

There are two types of outputs selectable in the setup menu:

- open collector (up to 30 V / 100 mA)
- open collector with a pull-up resistor 150  $\Omega$  connected to +5 V

Frequency range of energy pulse output: 0.02 Hz to 1 MHz

**Control in the Energy Mode**

- Push the **E** on the Instrument and then push the **AC** or **DC** to select the AC or DC mode. The display shows:

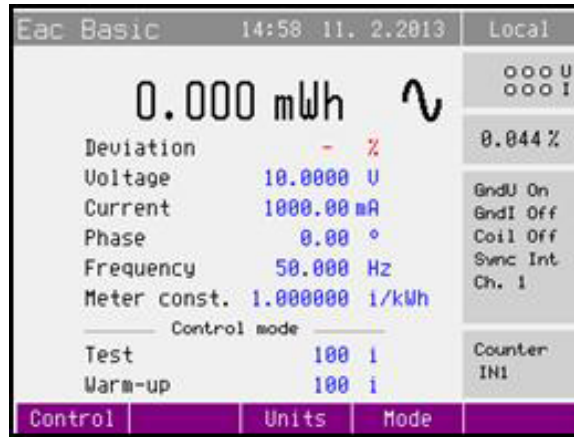

hoa118.jpg

- Main value – The running energy counter in the selected unit of measurement VAs, Ws, VARs
- Deviation between the energy meter (UUT) and Instrument – calculation is based on pulses generated by the energy meter
- Voltage at VOLTAGE OUTPUT HI-LO terminals
- Current at CURRENT OUTPUT HI-LO terminals
- Power factor or the phase shift between the voltage and current in °.
- Frequency, if ac power is selected
- Meter constant (number of pulses per kWh/kVAh/kVArh generated by the energy meter)
- Energy counting method (control mode)
- Uncertainty of energy and deviation from nominal

Set desired energy parameters with the numeric keypad, Rotary Knob or cursor buttons. Output power is not yet connected to the output terminals.

Connect the instrument to be calibrated to the VOLTAGE OUTPUT HI-LO and CURRENT OUTPUT HI-LO terminals or short the CURRENT OUTPUT HI-LO terminals if not providing current to the UUT.

Select the Control mode as described in the *Ways of Counting Energy (Control)* section below. Use the **Control** softkey to open the energy counting method selection menu. Each method is described below. Select the necessary method with the cursor buttons or the Rotary Knob. Push the Rotary Knob or the **select** softkey to confirm the selection.

Push **OPER**. The green LED is lit on **OPER** to indicate the connection of simulated electrical energy to the output terminals. The Product starts the generation of electrical energy. The Main Value shows the generated energy. Control Mode Parameters shows running time, counted pulses or measured frequency. Current terminals are disconnected as soon as the energy batch is finished. Voltage terminals are disconnected only if the parameter "Maintain Voltage Signal" is set to "Off". When "Maintain Voltage Signal" is set to "On", the Voltage terminals remain connected and the green LED on the Operate button remains lit after an Energy test. To start another energy test, push the Operate button. The voltage terminals can be disconnected by pushing **STBY**. Otherwise the voltage terminals are disconnected after **STBY** is pushed.

### **Warning**

**To prevent electric shock, do not touch any of the connections to the output terminals when any voltage is present. Do not make connections to the output terminals when any voltage is present.**

**When the Maintain Voltage signal in the Energy mode is activated, the Product continues to output the set voltage levels after completion of the Packet, Counter and Timed Energy Tests, and when the Control method is changed. These voltages can be lethal. Do not touch any of the connections to the output terminals when any voltage is present. Do not make connections to the output terminals when any voltage is present.**

#### *Power Factor Polarity (Lead/Lag Softkey)*

In cases where phase shift between voltage and current is shown as power factor, you can change its polarity with the **Lead/Lag** softkey. The lead polarity represents a capacitive load (current before voltage). The lag polarity represents an inductive load (voltage before current).

#### *Power Units (Units Softkey)*

The Product can show ac power (energy) in one of three ways:

1. Active power in W (Ws)
2. Reactive power in Var (VARs)

Use the **Units** softkey to open the units selection menu. Select the desired units with the cursor buttons or the rotary knob. Confirm the selection by pushing the rotary knob or the **Select** softkey. The value of displayed power is recalculated together with the new units selection. DC power (energy) can be shown only in W (Ws).

### **Methods of Energy Counting (Control)**

There are different methods to perform an energy test. The next sections explain these methods.

#### **Packet (Time Counting)**

The simplest (but least accurate) method is to set the time of the energy test. In Packet mode, also known as dose mode, the power from the output terminals is timed to deliver a set amount of energy to the meter under test. This method is not as accurate as the other methods because the start-up time of the Product is not synchronized with the UUT.

#### **Counter (Pulse counting)**

An accurate method to test energy meters is to count the pulses from the meter under test. This method is also called the “rolling start” method. The pulse output of the meter under test is connected to BNC input IN1. On the Product, set the Meter constant to match the meter's pulse output. Specify the warm-up period in terms of pulses from the meter under test and the test period. Push the Operate key to start the test. The Product starts to count energy after it counts the warm-up pulses from the meter. Counting is finished after the set number of "test" pulses is reached. The Product disconnects the current output terminals and shows energy delivered during the set number of "test" pulses, and displays the deviation from nominal as a percentage. The voltage terminals will still be connected if Maintain Voltage Test Signal is set to ON.

Push  to star another Counter energy test.

#### **Timer**

In Timer mode the Product delivers power over a specified time period. In this mode, the Meter pulse output is connected to BNC input IN1. The Product starts to count energy after the warm up period specified. Counting is finished after the time interval specified. The Product disconnects the current output terminals and shows the energy delivered over that time period. The deviation from nominal of the meter under test is shown as a percentage. The voltage terminals will still be connected if the Maintain Voltage Test Signal is ON.

Another Timer energy test can be started by pushing the Operate key.

#### **Free Run (Frequency Measuring)**

The Product measures frequency of pulses from a measured meter. The Meter pulse output must be connected to BNC input IN1 and the meter constant must be defined on the Product. Deviation between the Meter and the Instrument is continuously calculated and shown. The Instrument shows deviation between measured frequency and expected frequency as a %. This mode is useful for troubleshooting setups and is not recommended for the most accurate energy calibrations.

**Energy Modes (Mode Softkey)**

Output energy can be generated in different energy modes. See Tables 4-3 and 4-4:

**Table 4-3. AC Energy**

Mode	Name	Description
Basic	Eac Basic	AC energy basic mode. Phase shift between channels output voltages are fixed (120° and 240°). All parameters are the same for all channels. Number of active channels can be defined in Main menu (1, 2 or 3).
High I	Eac High I	In this mode current outputs of all channels are connected in parallel (with the optional High Current Adapter). Maximum current range is increased 3X to 90 A. Only voltage channel 1 is active in this mode.

**Table 4-4. DC Energy**

Mode	Name	Description
Basic	Edc Basic	DC energy basic mode. Only channel 1 is controlled in this mode.
High I	Edc High I	In this mode current outputs of all channels are connected in parallel (with the High Current Adapter). Current range is increased three times to 90 A. Only voltage channel 1 is active in this mode.

Use the **Mode** softkey to open the mode selection menu. Select the necessary mode with the cursor buttons or the rotary knob. Confirm the selection by pushing the rotary knob or the **Select** softkey. Output terminals are disconnected if a new mode is selected.

**Set the Energy in modes Edc Basic and Eac Basic**

The Product provides several methods of setting the value of generated energy. These methods are explained below.

**Set the Voltage**

- The energy (power) value can be changed by changing the voltage.
- Repeatedly push the **Sel** softkey until the voltage value is shown in edit mode (blue background).
- The value can be set with the numeric keypad and confirmed by pushing the **V** softkey. The value can also be set with the cursor buttons or rotary knob.

Energy (power) value is recalculated with the new set voltage and existing setting of current and power factor.

**Set the Current**

The energy (power) value can be changed by changing the current.

- Repeatedly push the **Sel** softkey until the current value appears in edit mode (blue background).
- The value can be set with the numeric keypad and confirmed by pushing the **mA** or **A** softkey. The value can also be set with the cursor buttons or rotary knob.

Energy (power) value is recalculated with the new set current and existing setting of voltage and power factor.

**Set the Power Factor (AC Power Only)**

If Ws or VARs is indicated, the energy (power) value can be changed by changing the power factor. Changing the power factor does not change the output apparent energy.

- Repeatedly push the **Sel** softkey until the power factor (phase) value appears in edit mode (blue background).
- The value can be set with the numeric keypad and confirmed by pushing the **Lead** or **Lag** softkey. The value can also be set with the cursor buttons or rotary knob.
- Energy (power) value is recalculated with the new set power factor and existing setting of current and voltage. The calculation is only made if active or reactive power is shown.

**Set the Frequency (AC Energy Only)**

- Repeatedly push the **Sel** softkey until the frequency value is shown in edit mode (blue background).
- The value can be set with the numeric keypad and confirmed by pushing the **Hz** softkey. The value can also be set with the cursor buttons or rotary knob.

**Set the Meter Constant**

Meter constant (expressed as i/kWh or i/kWs) defines the number of pulses sent by the Meter for selected energy unit (kWh or kWs), and should be set in the Counter, Timer, and Free Run modes.

- Repeatedly push the **Sel** softkey until the Meter constant value is shown in edit mode (blue background).
- The value can be set with the numeric keypad and confirmed by pushing the **Enter** softkey. The value can also be set with the cursor buttons or rotary knob.

**Set the Test and Warm-up Periods**

In the Counter or Timer control modes, repeatedly push the **Sel** softkey until “Test” or “Warm-up” values are shown in edit mode (blue background).

The value can be set with the numeric keypad and confirmed by the **Enter** softkey. The value can also be set with the cursor buttons or rotary knob

### **Set the Power in Modes Edc High I and Eac High I**

In this mode current outputs of all channels are connected in parallel (with the High Current Adapter). Current range is increased three times.

Output voltage terminals are on Channel 1 only.

The power setting is the same as in the Edc Basic and Eac Basic modes.

### **Generate Voltage**

The Product can generate calibrated voltages. Output terminals for voltage ranges are VOLTAGE OUTPUT HI – LO terminals. Depending on the setting of the Product, voltage up to 600 V ac can be present at the terminals.

Voltage setting range: 1 V ac to 600 V ac, 1 V dc up to 280 V dc

### **Control in the Voltage Mode**

1. Push **V** on the Product and then select ac or dc mode by pushing **AC** or **DC**. The display shows the subsequent data:
  - main voltage value at VOLTAGE OUTPUT HI-LO terminals
  - frequency, if ac voltage is selected
  - uncertainty of voltage output
  - Input: mA, volts, or frequency, depending upon Multimeter setting.
2. Set the necessary value of voltage with the numeric keypad, Rotary Knob, or cursor buttons. Output voltage is not yet connected to the output terminals.
3. Connect the Instrument to be calibrated to VOLTAGE OUTPUT HI-LO.
4. Push **OPER**. The green LED is lit on **OPER** to indicate the connection of output terminals.

### **Overload the Output Terminals**

If the output terminals are overloaded or short-circuited in the voltage mode, the Product disconnects the signal from the output terminals and shows the message "Output Overload".

### **Set the Voltage in Modes Vdc Basic and Vac Basic**

The Product has several methods to set the value of generated voltage.

#### **Set the Voltage**

Repeatedly push **↔** until the voltage value is shown in edit mode (blue background).

The value can be set with the numeric keypad and confirmed by pushing the **V** softkey. The value can also be set with the cursor buttons or rotary knob.



### Set the Frequency (AC Voltage Only)

Repeatedly push **↔** until the frequency value is shown in edit mode (blue background).

The value can be set with the numeric keypad and confirmed by pushing the **Hz** softkey. The value can also be set with cursor buttons or rotary knob.

## Generate Current

The Product can generate calibrated current. Output terminals for current ranges are CURRENT OUTPUT HI – LO terminals.

Current setting range: 8 mA to 30 A

When a 25 or 50 turn coil is used, ac current range is to 4500 A.

### Control in the Current Mode

Push **I** and then select ac or dc mode by pushing **AC** or **DC**. The display shows the subsequent data:

- main current through the CURRENT OUTPUT HI-LO terminals
  - frequency, if ac current is selected
  - uncertainty of current output
  - Input: mA, volts, or frequency, depending upon Multimeter setting.
1. Set the necessary value of current with the numeric keypad, rotary knob, or cursor buttons. Output current is not yet connected to the output terminals.
  2. Connect the Instrument to be calibrated to CURRENT OUTPUT HI-LO.
  3. Push **OPER**. The green LED is lit on **OPER** to indicate the connection of output terminals.
  4. If Coil x25 or Coil x50 setting is activated (see Calibrator Setup Menu), the displayed output is either 25 or 50 times the actual current output and the current coil needs to be connected to the output terminals. The Product can be used to calibrate clamp Ammeters up to 1500 A with the 5500A/COIL, up to 2250 A with the 52120A/COIL 3 kA and up to 4500 A with the 52120A/COIL 6 kA. Use the Basic I mode with the 5500A/COIL, and the High I mode with the 52120/COILs.

#### Note

*The 52120A/COIL 3 kA and 52120A/COIL 6 kA need to be powered with an external power supply, Fluke part number 4107239. The power supply provides 12 V dc to the cooling fan.*

### Overload the Output Terminals

When an open is detected at the current output terminals, or if the voltage at the current output terminals exceeds the Products specifications, the Product disconnects the output terminals and shows an “Output Overload” message. The same message can be shown when driving any one of the coils beyond its rated frequency specifications, depending upon the set current and the type of ammeter connected.

### Current Modes (Mode Softkey)

Output current can be generated in different current modes as shown in Tables 4-5 and 4-6:

**Table 4-5. AC Current**

Mode	Name	Description
Basic	lac Basic	AC current basic mode. Only channel 1 is controlled in this mode.
High I	lac High I	In this mode current outputs of all channels are connected in parallel (using the optional High Current Adapter). Current range is increased three times. Only channel 1 is controlled in this mode.

**Table 4-6. DC Current**

Mode	Name	Description
Basic	ldc Basic	DC current basic mode. Only channel 1 is controlled in this mode.
High I	ldc High I	In this mode current outputs of all channels are connected in parallel (using the optional High Current Adapter). Current range is increased three times. Only channel 1 is controlled in this mode.

Use the **Mode** softkey to open the mode selection menu. Select the necessary mode with the cursor buttons or the rotary knob. Confirm the selection by pushing the rotary knob or the **Select** softkey. Output terminals are disconnected if the new mode is selected.

### Set the Current in Modes ldc Basic and lac Basic

The Product has two ways to set the value of generated current. These are explained below.

#### Set the current:

1. Repeatedly push **→** until the current value is shown in edit mode (blue background).
2. Use the numeric keyboard to set the value and confirm by pushing the **mA** or **A** softkey. The value can also be set with the cursor buttons or rotary knob.

**Set the frequency (ac current only):**

1. Repeatedly push  until the frequency value is shown in edit mode (blue background).
2. Use the numeric keyboard to set the value and confirm by pushing the **Hz** softkey. The value can also be set with the cursor buttons or rotary knob.

**Set the Current in Modes Idc High I and Iac High I**

In this mode current outputs of all channels are connected in parallel (with the optional High Current Adapter). Current range is increased three times.

Current setting is the same as in modes Idc Basic and Iac Basic.

**Use the Multimeter**

The Product includes a built-in multimeter that can measure dc voltage, dc current and frequency. The meter is available in the power, voltage, and current functions, and is used to measure transducer outputs. The measured signal must be connected to the “METER INPUT” terminals. The mA, COM terminals are for current measurements. The V, COM terminals are for voltage and frequency measurements.

** Caution**

**To avoid damage to the multimeter, do not connect any of the multimeter inputs to the Products output terminals.**

Measurement function should be selected in Main Setup menu (item Meter).

Push  and  or use the rotary knob to select one of these functions:

- Voltage – dc voltage up to 12 V
- Current – dc current up to 25 mA
- Frequency – frequency up to 15 kHz

*Note*

*For Frequency measurement, the input signal must be within 0.2 V to 5 V. Square wave or pulse shape of the input signal is expected.*

## Product Use Tips

This section includes tips for Product use.

### Use the Isolated Current Outputs

The Product current outputs can be isolated from ground so that measurements can be made on external circuits energized to 450 V peak maximum above ground. The external circuits must only be energized by the Product voltage output terminals in this mode.

#### **⚠ Warning**

**To avoid electric shock and damage to the Product, never connect the Product current output terminals to a voltage source other than the Product voltage output terminals.**

If the Product current outputs are to be connected to a voltage terminal, either the current HI terminal or Current LO terminal can be connected. The current HI and LO terminals are electrically connected internally, and if one of the terminals is connected to high voltage, the other terminal will be at nearly the same voltage. These voltages can be lethal. Follow the Safe Working Practices listed below.

When an external voltage is connected to the current output terminals, the current LO terminal cannot be connected to ground. The Product GndI feature must be set to OFF. If an output voltage is  $>280$  V, the current outputs are no longer isolated from ground and the Product will put GndI to ON. If the output voltage is set to  $\leq 280$  V, the GndI feature will be set back to OFF.

Figure 4-1 shows a typical connection of the Product to a watthour energy meter where a 6003A supplies the voltage and the Product current terminals are effectively at the same voltage as the voltage terminals.

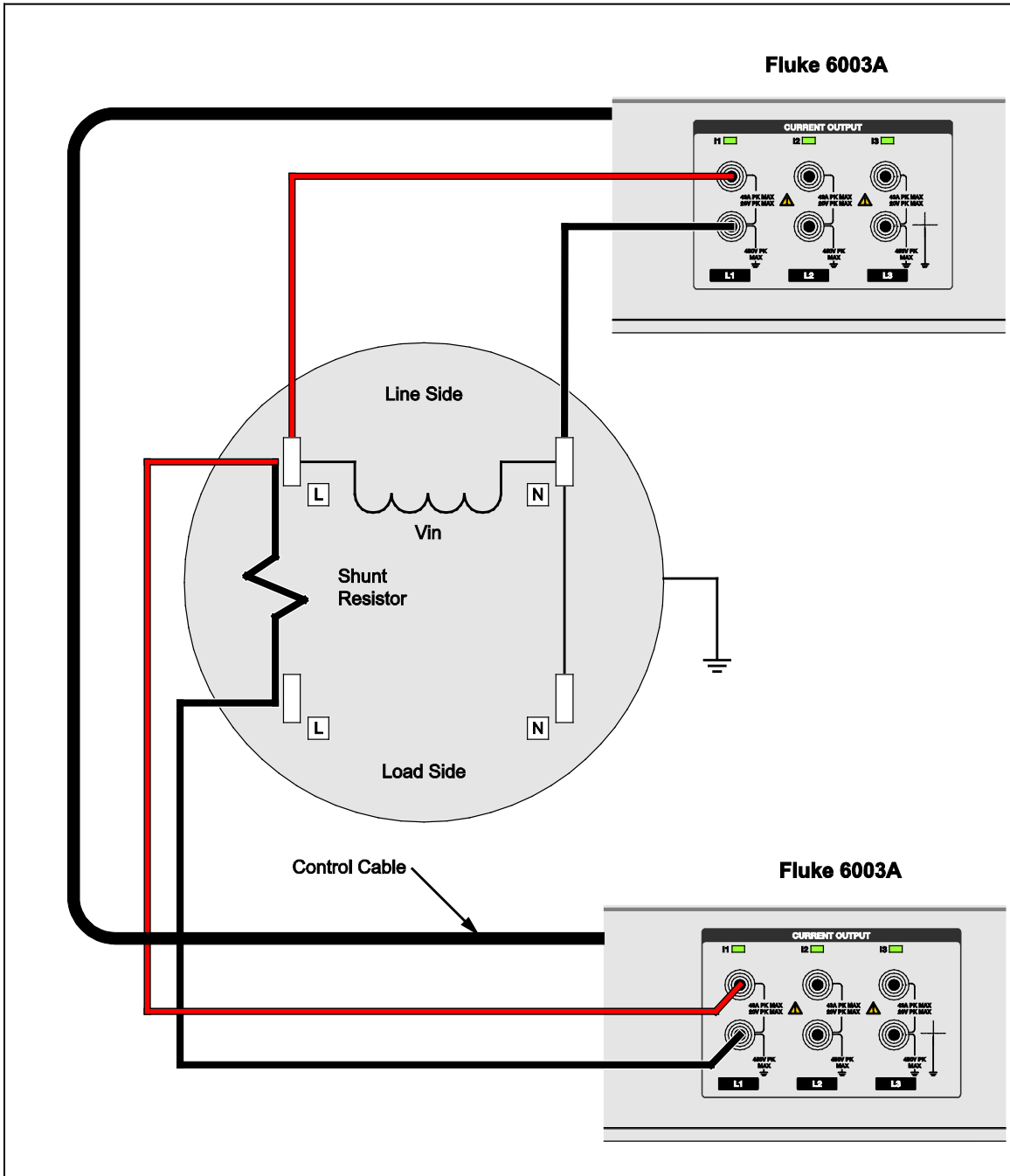

Figure 4-1. Isolated Current Outputs



hoa002.eps

## Safe Working Practices

### Warning

To prevent electric shock or personal injury, remove all cables from the terminals that are not used. When connections are made to a circuit that can be energized with voltages, always ensure there are no external voltages present before connecting to the Product. Voltage can be present at the loose ends of cables.

### **How to Connect the Product to the UUT**

1. Remove power from the UUT.
2. Push  to set the Product to standby.
3. Remove all connections to the terminals of the Product that are not used for the test.
4. Connect the test cables to the UUT.
5. Connect the test cables to the appropriate output terminals of the Product.
6. If the UUT requires its own mains power source, and does not require power from the Product, connect to that power source.
7. Turn on the mains power to the UUT, if applicable.
8. Push  to set the Product to operate.

### Caution

To prevent damage to the Product, do not connect mains power to any signal input or output terminal.

### **How to Disconnect the Product from the UUT**

1. Push  to set the Product to standby.
2. Remove mains power from UUT, if applicable.
3. Disconnect the test cables from the Product.
4. Disconnect the test cables from the UUT.

When you connect a high-current cable to a UUT, make sure the connections are tight. A loose connection can cause voltage over compliance and set the Product into an overload condition. A loose connection can cause the connection to overheat.

### **Use the Product to Power Energy Meters**

The Product voltage outputs have sufficient burden current to provide power to many watt-hour energy meters. When doing so, you may want to continuously apply power to the energy meter during various test sequences. The Product has a Maintain Voltage Signal Parameter that allows you to do so. See Chapter 3 for more details.

#### **⚠ Caution**

**To prevent damage to the Product, do not connect mains power to any signal input or output terminal.**

#### **⚠⚠ Warning**

**When the Maintain Voltage signal in the Energy mode is activated, the Product continues to output the set voltage levels after completion of the Packet, Counter and Timed Energy Tests, and when the Control method is changed. These voltages can be lethal. Do not touch any of the connections to the output terminals when any voltage is present. Do not make connections to the output terminals when any voltage is present.**





# Chapter 5

## **Verification, Calibration Adjustment, and Maintenance**

### **Introduction**

This chapter explains how to verify Product operation, make calibration adjustments, and details some basic operator maintenance.

### **Required Equipment**

Table 5-1 lists the necessary equipment for the procedures in this chapter.

**Table 5-1. Required Equipment**

<b>Equipment</b>	<b>Minimum Specifications</b>	<b>Recommended Model</b>
8 1/2 Digit Reference Multimeter	0.001 % specification on dc voltage and 10 ppm frequency specification	Fluke 8508A
AC Measurement Standard	50 ppm of reading or better for V ac	Fluke 5790A
Reference Current Shunts	0.005 % specification or better	A40B-2A, A40B-5A and A40B-50A
Reference Calibrator	Can provide 12 V dc with 0.01 % specification or better, 25 mA dc and 10 V, 15 kHz V ac	Fluke 5522A or 5502A
Power Quality Analyzer	0.1 % harmonic amplitude specification and 0.1 degrees harmonic phase specification.	Tektronix PA4000
Power Analyzer	With PP64, or other type with 0.003 degree phase specification	Fluke Norma 4000

*Note*

*The Radian Research RD33 Three Phase meter can be used as a substitute for the Tektronix PA4000 and Norma 4000, and is useful for testing three phases simultaneously, an optional procedure.*

## Verification Performance Tests

### Note

*The tests shown here are for the Product that has 6003A/E Energy and 6003A/PQ Power Quality options.*

This section contains the recommended verification performance tests for the Product. Performance tests should be performed at least yearly to ensure conformance to the Product Specifications.

### Configuration of the Product

The Product should be tested directly from the front-panel terminals. To reduce noise or interference with power line frequency in measuring circuits, use these settings (in Main menu):

- Current coil                      Coil Off
- Voltage sources GND          GndU On
- Current sources GND          GndI On

### Note

*If the Product or the multimeter is not grounded, higher noise levels can occur on the output terminals. Even with only one apparent ground in the measurement system, when the Product is connected to the ac measurement standard or reference multimeter, ground loops can arise through a power line connection. Ground loops can appear as higher noise, short-term stability issues, or non-harmonic distortion of the output signal. The use of toroidal chokes on the connection cables can be used to suppress the noise.*

The Product must be in a temperature-stabilized environment a minimum of 8 hours before the performance verification test is started. Also make sure the Product is turned on at least 1 hour prior to verification.

**Basic Steps of the Performance Verification Test**

Performance verification tests consists of:

- Voltage amplitude tests
- Frequency verification tests
- Modulation mode amplitude tests (0 % modulation)
- Modulation mode depth tests
- Current amplitude tests
- Harmonic mode amplitude tests
- Harmonic mode voltage phase tests
- Harmonic mode current phase tests
- Interharmonic mode amplitude tests
- Power amplitude tests
- Voltage – Current phase tests
- Current – Voltage phase tests
- Meter voltage, frequency and current tests

**Connections and Procedure Sequences**

This section describes the performance verification test for a voltage and current channel. After one channel is verified, repeat the same procedures for the other two channels. The test sequence minimizes the number of connections and re-connections from the Product to the measurement standard. Other test sequences are allowed, depending upon your laboratory practices.

All of the verification points are shown in the tables in each section. Deviations should not exceed specified limits. If the Product is out of limits for any of these tests, the appropriate function and range should be adjusted. It is not necessary to adjust all functions, but only the one which does not meet specification. See the *Calibration Adjustment* section that describes the calibration adjustment procedures.

*Note*

*Power up the Product for at least 1 hour in a laboratory environment at 23 ±1 °C.*

**VDC Amplitude Verification**

Connect the voltage output terminals of the Product to the voltage input of the reference multimeter. Using the dc voltage function of the multimeter, set appropriate parameters to achieve the best accuracy.

Function	Voltage Range	Value	Deviation Allowed
VDC	10 V	1 V	1.15 mV
	10 V	10 V	2.5 mV
	10 V	-1 V	1.15 mV
	10 V	-10 V	2.5 mV
	30 V	11 V	4.65 mV
	30 V	30 V	7.5 mV
	30 V	-11 V	4.65 mV
	30 V	-30 V	7.5 mV
	70 V	31 V	11.65 mV
	70 V	70 V	17.5 mV
	70 V	-31 V	11.65 mV
	70 V	-70 V	17.5 mV
	140 V	71 V	24.65 mV
	140 V	140 V	35 mV
	140 V	-71 V	24.65 mV
	140 V	-140 V	35 mV
	280 V	141 V	49.2 mV
	280 V	280 V	70 mV
280 V	-141 V	49.2 mV	
280 V	-280 V	70 mV	

**Frequency Verification**

Connect the voltage output terminals of the Product to the voltage input of the reference multimeter. Use the frequency measurement function on the reference multimeter.

Function	Output	Value	Deviation Allowed
Voltage	10 V	60 Hz	0.003 Hz
	10 V	500 Hz	0.025 Hz
	10 V	1.0 kHz	0.05 Hz

Note: Reference multimeter set to monitor Frequency in V ac mode.

**Modulation Mode Voltage Amplitude Verification (0 % Modulation)**

Use the reference multimeter in the AC voltage mode to make these measurements.

Function	Range	Value	Frequency	Deviation Allowed
VAC-MOD	10 V	1 V	50 Hz	20 mV
	10 V	10 V	60 Hz	20 mV
	30 V	11 V	50 Hz	60 mV
	30 V	30 V	60 Hz	60 mV
	70 V	31 V	50Hz	140 mV
	70 V	70 V	60 Hz	140 mV
	140 V	71 V	50Hz	280 mV
	140 V	140 V	60 Hz	280 mV
	280 V	141 V	50Hz	560 mV
	280 V	280 V	60 Hz	560 mV

Note: Rectangular Modulation ON, 0 % modulation

**Voltage Modulation Mode Depth Verification**

Use the peak-to-peak measurement function on the reference multimeter.

Function	Range	Output	Value	Modulation Frequency	Nominal Pk-Pk Value	Deviation Allowed
VAC_MOD	280 V	230 V	20.000 %	50 mHz	92.0 V	560 mV
	140 V	115 V	30.000 %	50 mHz	69 V	280 mV

Note: 55 Hz Fundamental, Rectangular Modulation ON, reference multimeter set to Peak-to-Peak

*DC Current Amplitude Verification*

1. Connect the current outputs of the Product to the current inputs of the reference multimeter and later to the appropriate A40B current shunt.
2. Perform the dc current amplitude verification for all currents that can be measured directly by the 200 mA range of the multimeter.
3. Perform the dc and ac current amplitude verification with the A40B current shunt that gives the largest voltage output within the limits of the current shunt. The A40B is used in conjunction with the reference multimeter in the voltage mode.

Function	Range	Value	Deviation Allowed
IDC	300 mA	30 mA	35.25 $\mu$ A
	300 mA	80 mA	44.0 $\mu$ A
	300 mA	110 mA	49.3 $\mu$ A
	300 mA	160 mA	58.0 $\mu$ A
	300 mA	210 mA	66.8 $\mu$ A
	300 mA	260 mA	75.5 $\mu$ A
	300 mA	300 mA	82.5 $\mu$ A
	300 mA	-30 mA	35.25 $\mu$ A
	300 mA	-300 mA	82.5 $\mu$ A
	300 mA	10 mA	31.75 $\mu$ A
	300 mA	-10 mA	31.75 $\mu$ A
	1 A	0.31 A	0.1543 mA
	1 A	-0.31 A	0.1543 mA
	1 A	1 A	0.275 mA
	1 A	-1 A	0.275 mA
	2 A	1.1 A	0.393 mA
	2 A	1.8 A	0.515 mA
	2 A	-1.1 A	0.393 mA
	2 A	-1.8 A	0.515 mA
	5 A	2.1 A	0.868 mA
	5 A	5 A	1.375 mA
	5 A	-2.1 A	0.868 mA
	5 A	-5 A	1.375 mA
	10 A	5.1 A	2.571 mA

Function	Range	Value	Deviation Allowed
IDC	10 A	10 A	3.60 mA
	10 A	-5.1 A	2.571 mA
	10 A	-10 A	3.60 mA
	30 A	10.1 A	6.97 mA
	30 A	-10.1 A	6.97 mA
	30 A	30 A	11.85 mA
	30 A	-30 A	11.85 mA
Note: Measure all currents <200 mA directly with the reference multimeter. A40B current shunts are used for all other values.			

*AC Current Amplitude Verification*

Function	Range	Value	Frequency	Deviation Allowed
IAC	300 mA	10 mA	55 Hz	31.8 μA
	300 mA	10 mA	1 kHz	62.1 μA
	300 mA	30 mA	55 Hz	35.3 μA
	300 mA	300 mA	55 Hz	82.5 μA
	300 mA	300 mA	1 kHz	123 μA
	1 A	0.31 A	55 Hz	0.153 mA
	1 A	0.31 A	1 kHz	0.265 mA
	1 A	1 A	55 Hz	0.275 mA
	1 A	1 A	1 kHz	0.41 mA
	2 A	1.1 A	55 Hz	0.393 mA
	2 A	1.1 A	1 kHz	0.631 mA
	2 A	1.8 A	55 Hz	0.515 mA
	2 A	1.8 A	1 kHz	0.778 mA
	5 A	2.1 A	55 Hz	0.868 mA
	5 A	2.1 A	1 kHz	1.44 mA
	5 A	5 A	55 Hz	1.38 mA
	10 A	5.1 A	55 Hz	2.57 mA
	10 A	10 A	55 Hz	3.6 mA
	10 A	10 A	1 kHz	4.8 mA
	30 A	10.1 A	55 Hz	6.97 mA
30 A	30 A	55 Hz	11.9 mA	
30 A	30 A	1 kHz	16.5 mA	
Note: A40B current shunts used for all values.				

*Voltage from the Current Terminals Amplitude Verification*

Set the Product to output voltage from the current terminals, and connect the current output terminals of the Product to the voltage input of the reference multimeter.

Function	Range	Value (V)	Frequency	Deviation Allowed
VDC	0.02 V	0.001	N/A	20.5 $\mu$ V
	0.02 V	-0.001		20.5 $\mu$ V
	0.02 V	0.019		29.5 $\mu$ V
	0.02 V	-0.019		29.5 $\mu$ V
	0.33 V	0.021		208.5 $\mu$ V
	0.33 V	-0.021		208.5 $\mu$ V
	0.33 V	0.32		358 $\mu$ V
	0.33 V	0.32		358 $\mu$ V
	5 V	0.34		1.17 mV
	5 V	-0.34		1.17 mV
	5 V	5		3.5 mV
	5 V	-5		3.5 mV
VAC	0.02 V	0.001	55 Hz	20.5 $\mu$ V
	0.02 V	0.019	55 Hz	29.5 $\mu$ V
	0.33 V	0.3	55 Hz	348 $\mu$ V
	5 V	4	55 Hz	3.0 mV



**Modulation Mode Current Amplitude Verification (0 % Modulation)**

Use the A40B current shunts along with the reference multimeter to make these measurements.

Function	Range	Value	Frequency	Deviation Allowed
IAC-MOD	300 mA	30 mA	50 Hz	600 $\mu$ A
	300 mA	300 mA	60 Hz	600 $\mu$ A
	1 A	0.4 A	50 Hz	2 mA
	1 A	1 A	60 Hz	2 mA
	2 A	1.1 A	50 Hz	4 mA
	2 A	2 A	60 Hz	4 mA
	5 A	2.1 A	50 Hz	10 mA
	5 A	5.1 A	60 Hz	10 mA
	10 A	5 A	50 Hz	20 mA
	10 A	10.1 A	60 Hz	20 mA
	30 A	10 A	50 Hz	60 mA
	30 A	30 A	60 Hz	60 mA

Note: Rectangular Modulation ON, 0% modulation. A40B current shunts used for all values.

**Current Modulation Mode Depth Verification**

Use the peak-to-peak measurement function on the reference multimeter with the A40B shunts.

Function	Range	Output	Modulation	Modulation Frequency	Nominal Pk-Pk Value	Deviation Allowed
IAC_MOD	2 A	1.6	30.000 %	50 mHz	0.96 A	4 mA
	30 A	15	20.000 %	50 mHz	6.0 A	60 mA

Note: 55 Hz Fundamental, Rectangular Modulation ON, A40B current shunts used for all values, reference multimeter set to Peak-to-Peak.

**VAC Amplitude Verification**

Connect the input of the AC Measurement Standard to the Products voltage outputs.

Function	Range	Value	Frequency	Deviation allowed
VAC	10 V	1 V	55 Hz	1.12 mV
	10 V	5 V	55 Hz	1.6 mV
	10 V	10 V	55 Hz	2.2 mV
	10 V	10 V	1 kHz	2.6 mV
	30 V	11 V	55 Hz	4.3 mV
	30 V	30 V	55 Hz	6.6 mV
	30 V	30 V	1 kHz	7.8 mV
	70 V	31 V	55 Hz	10.7 mV
	70 V	70 V	55 Hz	15.4 mV
	70 V	70 V	1 kHz	18.2 mV
	140 V	71 V	55 Hz	22.5 mV
	140 V	140 V	55 Hz	30.8 mV
	140 V	140 V	1 kHz	36.4 mV
	280 V	141 V	55 Hz	44.9 mV
	280 V	200 V	55 Hz	52 mV
	280 V	280 V	55 Hz	61.6 mV
	280 V	280 V	1 kHz	72.8 mV
	600 V	300 V	55 Hz	108 mV
	600 V	300 V	1 kHz	132 mV
	600 V	450 V	55 Hz	132 mV
600 V	600 V	55 Hz	156 mV	

**Power Amplitude Verification**

Do the power amplitude verification no later than 1 hour after doing the ac current amplitude verification and V ac amplitude verification as those measured values are used to compute the power from the Product. Connect the power analyzer to the Product output terminals. The power analyzer is used to measure the phase angle between the voltage and current.

The measured power value is given by  $P = V * I * \cos(\Phi)$ , where V is the corresponding value measured in the *VAC Amplitude Verification* section and I is the corresponding value measured in the *AC Current Amplitude Verification* section. Alternatively, the Radian Research RD33 can be used to measure the power directly.  $\Phi$  is the phase angle measured by the power analyzer.

Function	Voltage Output	Current Output	Phase	Frequency (Hz)	Power Output	Deviation Allowed
PDC	280 V	30 mA	N/A	N/A	8.4 W	0.01 W
	280 V	1 A			280 W	0.108 W
	140 V	5 A			700 W	0.269 W
	140 V	30 A			4200 W	2.008 W
PAC	280 V	300 mA	0 °	55 Hz	84 W	0.031 W
	280 V	300 mA	60 °	55 Hz	42 W	0.020 W
	280 V	300 mA	300 °	55 Hz	42 W	0.020 W
	280 V	1 A	0 °	55 Hz	280 W	0.103 W
	280 V	1 A	60 °	55 Hz	140 W	0.066 W
	280V	1 A	300 °	55 Hz	140 W	0.066 W
	140 V	5 A	0 °	55 Hz	700 W	0.259 W
	140 V	5 A	60 °	55 Hz	350 W	0.165 W
	140 V	5 A	300 °	55 Hz	350 W	0.165 W
	140 V	30 A	0 °	55 Hz	4200 W	1.93 W
	140 V	30 A	60 °	55 Hz	2100 W	3.32 W
	140 V	30 A	300 °	55 Hz	2100 W	3.32 W

*Voltage Current Phase Verification*

Function	Voltage Output	Current Output	Phase	Frequency	Deviation Allowed
PHA-U	5 V	1 A	60 °	55 Hz	0.01 °
	20 V	1 A	60 °	55 Hz	0.01 °
	50 V	1 A	60 °	55 Hz	0.01 °
	125 V	1 A	60 °	55 Hz	0.01 °
	200 V	1 A	60 °	55 Hz	0.01 °
	300 V	1 A	60 °	55 Hz	0.01 °
Note: Voltage phase performance verification can also be checked relative to the internal phase reference, Phase Ref Out, on the rear panel of the Product.					

*Current Voltage Phase Verification*

Function	Voltage Output	Current Output	Phase	Frequency	Deviation Allowed
PHA-I	10 V	200 mA	60 °	55 Hz	0.01 °
	10 V	800 mA	60 °	55 Hz	0.01 °
	10 V	1.8 A	60 °	55 Hz	0.01 °
	10 V	4 A	60 °	55 Hz	0.01 °
	10 V	8 A	60 °	55 Hz	0.01 °
	10 V	15 A	60 °	55 Hz	0.05 °
PHA-IOU (Voltage from Current to Voltage phase verification)	10 V	5 V	60 °	55 Hz	0.01 °
Note: Current phase performance verification can also be checked relative to the internal phase reference, Phase Ref Out, on the rear panel of the Product.					

**Harmonic Mode Amplitude Verification**

Connect the Product voltage and current output terminals to the power quality analyzer.

Function	Range	RMS Output	Harmonic #	Harmonic Amplitude (% of RMS)	Deviation Allowed
VAC-HAR	10	8	3	12.00 %	0.125 %
	10	8	5	16.00 %	0.125 %
	10	8	7	14.00 %	0.125 %
	10	8	13	3.00 %	0.125 %
	10	8	25	3.00 %	0.125 %
	10	8	63	3.00 %	0.25 %
	280	230	3	12.00 %	0.122 %
	280	230	5	16.00 %	0.122 %
	280	230	7	14.00 %	0.122 %
	280	230	13	3.00 %	0.122 %
	280	230	25	3.00 %	0.122 %
	280	230 (100 Hz)	63	3.00 %	0.243 %
	280	230 (100 Hz)	30	5 %	0.122 %
	280	230 (100 Hz)	30	5 %	0.243 %
IAC-HAR	2	1.6	3	12.00 %	0.125 %
	2	1.6	5	16.00 %	0.125 %
	2	1.6	7	14.00 %	0.125 %
	2	1.6	13	3.00 %	0.125 %
	10	8	25	3.00 %	0.25 %
	10	8	63	3.00 %	0.50 %
	30	25	3	12.00 %	0.24 %
	30	25	5	16.00 %	0.24 %
	30	25	7	14.00 %	0.24 %
	30	25	13	3.00 %	0.24 %
	30	25	25	3.00 %	0.24 %
	30	25	63	5.00 %	0.96 %
	30	25 (100 Hz)	30	5.00 %	0.24 %
	30	25 (100 Hz)	50	5.00 %	0.96 %

Note: 55 Hz Fundamental (unless otherwise indicated), 0 ° phase shift from fundamental

*Interharmonic Mode Amplitude Verification*

55 Hz fundamental

Function	Range	RMS Output	Interharmonic Frequency	Interharmonic Amplitude	Deviation Allowed
VAC-IHAR	10 V	10 V	85.5 Hz	2 V	10 mV
	280 V	230 V	82.5 Hz	30 V	280 mV
IAC-IHAR	300 mA	270 mA	85.5 Hz	30 mA	300 $\mu$ A
	30 A	25 A	82.5 Hz	1 A	60 mA
Note: If using a reference power analyzer that cannot measure Interharmonics, change the Interharmonic frequency to 110 Hz.					

*Harmonic Mode Voltage Phase Verification*

55 Hz fundamental

Function	Voltage Output (RMS)	Harmonic #	Harmonic %	Phase	Deviation Allowed
PHA-UHA	10	4	19	60 °	0.396 °
	10	19	25	60 °	1.881 °
	200	7	29	60 °	0.693 °
	200	11	20	60 °	1.089 °

*Harmonic Mode Current Phase Verification*

55 Hz fundamental

Function	Current Output (RMS)	Harmonic #	Harmonic %	Phase	Deviation Allowed
PHA-IHA	800	3	14	60 °	0.297 °
	1.5	8	16	60 °	0.792 °
	15	12	27	60 °	1.188 °
	19	20	29	60 °	1.980 °

*Multimeter Voltage Verification*

Function	Range	Input	Deviation Allowed
VDC	12 V	2.00 V	1.4 mV
	12 V	4.00 V	1.6 mV
	12 V	6.00 V	1.8 mV
	12 V	8.00 V	2 mV
	12 V	10.00 V	2.2 mV
	12 V	-2.00 V	1.4 mV
	12 V	-10.00 V	2.2 mV
	12 V	1.00 V	1.3 mV

The internal multimeter can be verified by using either an external reference calibrator or by using the voltage and current outputs from the Product in the voltage and current modes. Connect the Product internal multimeter voltage input terminals to the output terminals of the reference calibrator or the appropriate output terminals of the Product. When using the Product voltage and current outputs, all output values must be measured by the reference multimeter.

*Multimeter Frequency Verification*

Function	Range	Input	Frequency	Deviation Allowed
VDC	1 kHz	10 V	120 Hz	6 mHz
	1 kHz	10 V	1 kHz	0.05 Hz

If the Fluke 5502A is used, the frequency value should be measured by the reference multimeter in parallel with the Product multimeter. The Fluke 5522A frequency specification is adequate for this test and a parallel measurement is not necessary.

Connect the Product internal multimeter current input terminals to the output terminals of the reference calibrator. The exact value of the reference calibrator output should be measured by connecting the reference multimeter in series with this setup.

*Multimeter Current Verification*

Function	Range	Input	Deviation Allowed
IDC	25 mA	8.0 mA	3.3 $\mu$ A
	25 mA	10.0 mA	3.5 $\mu$ A
	25 mA	15.0 mA	4 $\mu$ A
	25 mA	20.0 mA	4.5 $\mu$ A
	25 mA	24.0 mA	4.9 $\mu$ A
	25 mA	-8.0 mA	3.3 $\mu$ A
	25 mA	-24.0 mA	4.9 $\mu$ A
	25 mA	-15.0 mA	4 $\mu$ A



## Calibration Adjustment Principles

The Product has a built-in calibration adjustment procedure. This lets the Product be readjusted by the user. Use the buttons and menu or the remote interface to recalibrate the Product.

The Product can be adjusted:

- Completely, for example, all functions are adjusted for all of the recommended points.
- Partially by function, for example, only selected functions are adjusted.
- Partially by points, for example, only selected points are adjusted for any of the functions.

Complete calibration adjustment consists of all individual calibration adjustments done in the order defined by the Calibration Menu. If an item of the Calibration Menu, for example, "Voltage DC#1" is selected, it is not necessary to adjust all ranges defined by the calibration algorithm. If calibration adjustment of all ranges is not possible (the necessary reference is not available, for example), old calibration data can be confirmed and a current step of the calibration can be skipped.

### Caution

**The calibration adjustment process can be interrupted at any point during the procedure. However, a particular calibration adjustment can influence other parameters of the Product and the specifications of the Product are guaranteed only when the full calibration adjustment and verification performance procedures are done.**

An overview of the calibration adjustment process is:

- AC voltage (Voltage AC#x) calibration sets two fixed points for all voltage ranges. The frequency is 55 Hz.
- AC current (Current AC#x) calibration sets two fixed points for all current ranges. The frequency is 55 Hz.
- DC voltage (Voltage DC#x) calibration sets two fixed points for all voltage ranges and for both polarities (+ and -).
- DC current (Current DC#x) calibration sets two fixed points for all current ranges and for both polarities (+ and -).

- AC modulation voltage (Voltage MOD#x) calibration sets two fixed points for all voltage ranges. The frequency is 55 Hz. These calibration values are used in P Harmonic and P Interharmonic function modes.
- AC modulation current (Current MOD#x) calibration sets two fixed points for all current ranges. The frequency is 55 Hz. These calibration values are used in P Harmonic and P Interharmonic function modes.
- Low voltage (Voltage DC#x) calibration sets a fixed point for all voltage ranges. The same calibration values are used for low-voltage ac ranges.

*Note*

*X is the ordinal number of the output channel.*

- Meter calibration is done for 10 V dc, 20 mA dc and 10 kHz.

**Access to the Calibration Adjustment Procedure**

A calibration password is necessary to access the calibration procedure. The default calibration password is "0". See the *Features and Basic Operation* chapter for more information about the calibration password.

To access the Adjustment Procedure:

1. Push **MENU** to open the Main menu.
2. Select the Calibration submenu and push the **Select** softkey.
3. The Product requests the entry of the calibration password. With the numeric keyboard, enter the correct calibration code and push **ENTER**.

If the correct calibration code is entered, the Calibration Menu list is shown in Figure 5-1:

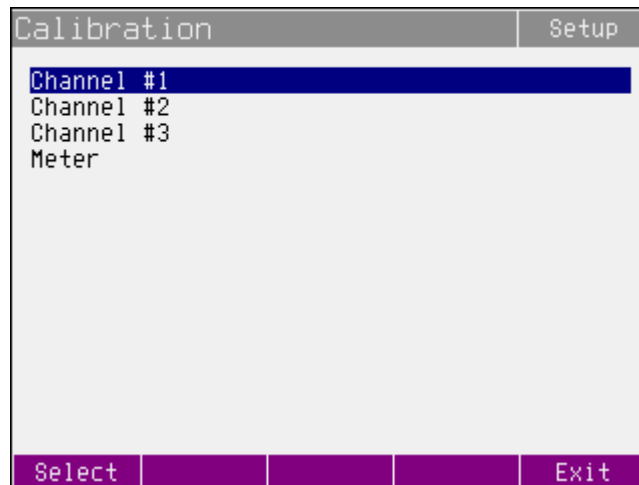



Figure 5-1. Calibration Menu

hoa009.bmp

If an incorrect calibration code is entered, “**Bad calibration code!**” shows on the display for approximately 3 seconds.

4. Use  and  to move the cursor through the list of calibration channels (Channels 1, 2, or 3) or Meter that is the calibration data for the internal meter).



Each item from the list shown above has this submenu:

Voltage AC#x	AC voltage calibration
Current AC#x	AC current calibration
Voltage DC#x	DC voltage calibration
Current DC#x	DC current calibration
Voltage MOD#x	AC voltage in modes P Harmonic and P Interharmonic calibration
Current MOD#x	AC current in modes P Harmonic and P Interharmonic calibration
Low voltage DC#x	DC and AC voltage from current calibration

*Note*

*X is the ordinal number of the output channel.*

**Select the Calibration Adjustment Type**

After the Calibration Menu is shown, any of the partial calibration adjustments can be selected. Use  and  to move the cursor through the list. After the required function to be adjusted is selected, push the **Select** softkey.

Data such as in Figure 5-2 is shown (this example is valid for Voltage AC#1):

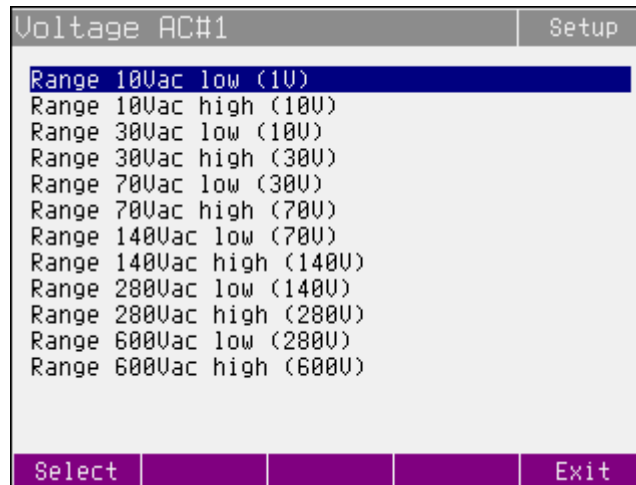

**Figure 5-2. Voltage AC#1 Screen**



hoa010.bmp

Use the **Select** softkey to choose the necessary calibration point from the list shown. Once selected, this data is shown:

**Write** – The new calibration adjustment value is entered into the memory, the old value is replaced. The Product returns to the previous menu.

**Skip** – The current calibration adjustment step is skipped, the old value is retained in the memory. The Product returns to the previous menu.

The display shows the range that is being adjusted (**Range 10Vac**), and the nominal value to be measured by the external reference multimeter (**1V**).

Use  and , the rotary knob, or the numeric keyboard to adjust the value on the display as in Figure 5-3.

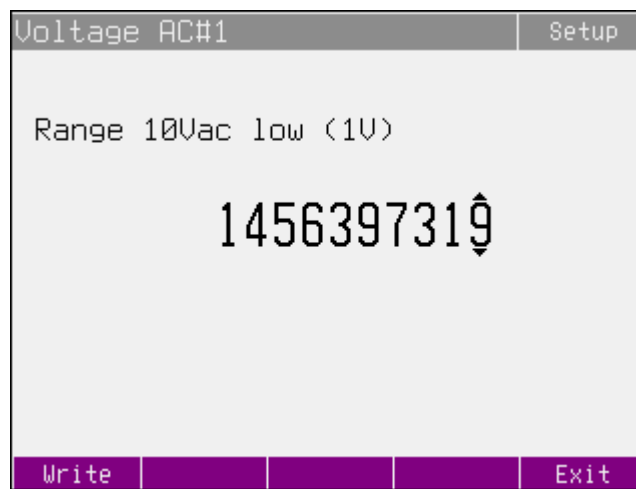

Figure 5-3. Voltage AC#1 Write Screen

hoa011.bmp

The output signal measured by the external reference multimeter should read the nominal calibration adjustment point. When the nominal output value is reached, push the **Write** softkey to write the new calibration value to the calibration memory. If the **Exit** softkey is pushed, the Product ignores the new value and old value is retained.

The procedure is repeated for all calibration points of the selected function. If the **Exit** softkey is pushed, the Product returns back to the previous menu level.

### **Termination of the Calibration Adjustment Process**

To terminate calibration adjustment, repeatedly push the **Exit** softkey until the Product returns to the Main menu.

### **Calibration Points**

Each Product function has assigned fixed-calibration points that have to be set as the product is calibrated. A summary of all calibration adjustment points are shown at the end of this section.

The Product does not need calibration adjustment for:

- Frequency
- Phase relationship (power factor) of output voltage and current in ac power and ac energy generation modes
- DC and ac power and energy

### **Complete Calibration Adjustment Procedure**

Follow the procedures in this section to adjust the calibration of the Product.

#### **Enter the Calibration Menu**

Before the Product can be adjusted it is necessary to enter the Calibration Menu. To enter the menu:

1. Connect the Product and the reference multimeter to the mains and turn them on for at least 3 hours in a laboratory environment of  $23 \pm 1$  °C.
2. Push **MENU** to show the Main menu.
3. Select **Calibration**.
4. Push the **Select** softkey to enter the Calibration Menu.
5. Enter the calibration adjustment code.
6. Push **ENTER** (the default calibration adjustment code is "0").

Follow the subsequent procedures to adjust the calibration of the Product.

### AC Voltage Ranges Calibration Adjustment

To adjust the calibration of the ac voltage ranges:

1. Connect the voltage input terminals of the ac measurement standard to the VOLTAGE OUTPUT HI - LO terminals of the Product.
2. Select **Voltage AC#1** from the Calibration Menu.
3. Push the **Select** softkey to confirm.
4. Change the Product output terminals to **Operate**.
5. Follow the instructions provided on the Product display and Table 5-2 to adjust the Product output for each calibration adjustment point.
6. To adjust the Product output to the calibration adjustment points, push the **Select** softkey and use **0**, **0**, **▲**, and **▼**, the rotary knob, or numeric keyboard to adjust the output to the nominal value.
7. Push the **Write** softkey to confirm the new value. To skip a calibration adjustment point where calibration has already been entered, push the **Exit** softkey.
8. Switch the output terminals to **Standby**.
9. Disconnect the ac measurement standard from the Product.
10. Repeat steps 1 through 8 also for Voltage AC#2 and Voltage AC#3.

Table 5-2. Voltage AC function (Voltage AC#x)

Nominal Value [V]	Set Limits [V]	Range [V]
1 V	100 $\mu$ V	10 V
10 V	500 $\mu$ V	10 V
10 V	1 mV	30 V
30 V	2 mV	30 V
30 V	4 mV	70 V
70 V	4 mV	70 V
70 V	7 mV	140 V
140 V	7 mV	140 V
140 V	15 mV	280 V
280 V	15 mV	280 V
280 V	40 mV	600 V
600 V	40 mV	600 V

### **AC Current Ranges Calibration Adjustment**

To adjust the calibration of the ac current ranges:

1. Select **Current AC#1** from the Calibration Menu.
2. Push the **Select** softkey to confirm.

Current shunts should be used for all ac current range calibration adjustments. Use the smallest A40B shunt for a given output. Stay within the current limits of that shunt.

3. Switch the Product output terminals to **Operate**.
4. Follow the instructions provided on the Product display and Table 5-3 to adjust the Product output for the calibration points.
5. To adjust the Product output to the calibration adjustment points, push the **Select** softkey and use **0**, **0**, **▲**, and **▼**, the rotary knob, or numeric keyboard to adjust the output to the nominal value.
6. Push the **Write** softkey to confirm the new value. To skip a calibration adjustment point where calibration has already been entered, push the **Exit** softkey.
7. Repeat steps 1 through 6 for Current AC#2 and Current AC#3.

Table 5-3. Current AC Function (Current AC#x)

Nominal Value [A]	Set Limits [A]	Range [A]
30 mA	10 $\mu$ V	300 mV
300 mA	15 $\mu$ V	300 mV
300 mA	30 $\mu$ V	1 V
1 A	50 $\mu$ V	1 V
1 A	100 $\mu$ V	2 V
2 A	100 $\mu$ V	2 V
2 A	200 $\mu$ V	5 V
5 A	250 $\mu$ V	5 V
5 A	500 $\mu$ V	10 V
10 A	500 $\mu$ V	10 V
10 A	1 mV	30 V
30 A	1.5 mV	30 V



### DC Voltage Ranges Calibration Adjustment

To adjust the calibration of the dc voltage ranges:

1. Select **Voltage DC#1** from the Calibration Menu.
2. Push the **Select** softkey to confirm.
3. Switch the Product output terminals to **Operate**.
4. Follow the instructions provided on the Product display and Table 5-4 to adjust the Product output for the calibration adjustment points.
5. To adjust the Product output to the calibration adjustment points, push the **Select** softkey and use **0,0,⏪**, and **⏩**, the rotary knob, or numeric keyboard to adjust the output to the nominal value.
6. Push the **Write** softkey to confirm the new value. To skip a calibration adjustment point where calibration has already been entered, push the **Exit** softkey.
7. Repeat steps 1 through 6 for Voltage DC#2 and Voltage DC#3.

**Table 5-4. Voltage DC Function (Voltage DC#x)**

Nominal Value [V]	Set Limits [V]	Range [V]
1 V	100 $\mu$ V	10 V
10 V	500 $\mu$ V	10 V
-1 V	100 $\mu$ V	-10 V
-10 V	500 $\mu$ V	-10 V
10 V	1 mV	30 V
30 V	2 mV	30 V
-10 V	1 mV	-30 V
-30 V	2 mV	-30 V
30 V	4 mV	70 V
70 V	4 mV	70 V
-30 V	4 mV	-70 V
-70 V	4 mV	-70 V
70 V	7 mV	140 V
140 V	7 mV	140 V
-70 V	7 mV	-140 V
-140 V	7 mV	-140 V
140 V	15 mV	280 V
280 V	15 mV	280 V
-140 V	15 mV	-280 V
-280 V	15 mV	-280 V

### DC Current Ranges Calibration Adjustment

To adjust the calibration of the dc current ranges:

1. Select **Current DC#1** from the Calibration Menu.
2. Push the **Select** softkey to confirm.

Current shunts should be used for all dc current range calibration adjustments except for  $\pm 30$  mA outputs which should be measured directly by the reference multimeter. Use the smallest A40B shunt for a given output, staying within the current limits of that shunt.

3. Switch the Product output terminals to **Operate**.
4. Follow the instructions provided on the Product display and Table 5-5 to adjust the Product output for the calibration adjustment points.
5. To adjust the Product output to the calibration adjustment points, push the **Select** softkey and use **0**, **0**, **0**, and **0**, the rotary knob, or numeric keyboard to adjust the output to the nominal value.
6. Push the **Write** softkey to confirm the new value. To skip a calibration adjustment point where calibration has already been entered, push the **Exit** softkey.
7. Repeat steps 1 through 6 for Current DC#2 and Current DC#3.

Table 5-5. Current DC Function (Current DC#x)

Nominal Value [A]	Set Limits [A]	Range [A]
30 mA	10 $\mu$ A	300 mA
300 m	15 $\mu$ A	300 mA
-30 m	10 $\mu$ A	-300 mA
-300 m	15 $\mu$ A	-300 mA
300 m	30 $\mu$ A	1 mA
1	50 $\mu$ A	1
-300 m	30 $\mu$ A	-1
-1	50 $\mu$ A	-1
1	100 $\mu$ A	2
2	100 $\mu$ A	2
-1	100 $\mu$ A	-2
-2	100 $\mu$ A	-2
2	200 $\mu$ A	5
5	250 $\mu$ A	5
-2	200 $\mu$ A	-5

**Table 5-5. Current DC Function (Current DC#x) (cont.)**

Nominal Value [A]	Set Limits [A]	Range [A]
-5	250 $\mu$ A	-5
5	500 $\mu$ A	10
10	500 $\mu$ A	10
-5	500 $\mu$ A	-10
-10	500 $\mu$ A	-10
10	1 mA	30
30	1.5 mA	30
-10	1 mA	-30
-30	1.5 mA	-30

**AC Voltage Modulation Ranges Calibration Adjustment (P Harmonic, P Interharmonic Modes)**

To adjust the calibration of the ac voltage modulation ranges:

1. Select **Voltage MOD#1** from the Calibration Menu.
2. Push the **Select** softkey to confirm.
3. Switch the Product output terminals to **Operate**.
4. Follow the instructions provided on the Product display and Table 5-6 to adjust the Product output for the calibration adjustment points.
5. To adjust the Product output to the calibration adjustment points, push the **Select** softkey and use **0,0,▲**, and **▼**, the rotary knob, or numeric keyboard to adjust the output to the nominal value.
6. Push the **Write** softkey to confirm the new value. To skip a calibration adjustment point where calibration has already been entered, push the **Exit** softkey.
7. Switch output terminals to **Standby**.
8. Disconnect the reference multimeter from the Product.
9. Repeat steps 1 through 7 for Voltage MOD#2 and Voltage MOD#3.

**Table 5-6. Voltage AC Modulation Function (Voltage MOD#x)**

Nominal Value [V]	Set Limits [V]	Range [V]
1	100 $\mu$ V	10
10	500 $\mu$ V	10
10	1 mV	30
30	2 mV	30
30	4 mV	70
70	4 mV	70
70	7 mV	140
140	7 mV	140
140	15 mV	280
280	15 mV	280

**AC Current Modulation Ranges Calibration Adjustment (P Harmonic, P Interharmonic Modes)**

To adjust the calibration of the ac current modulation ranges:

1. Select **Current MOD#1** from the Calibration Menu.
2. Push the **Select** softkey to confirm.  
Current shunts should be used for all ac current range calibration adjustments. Use the smallest A40B shunt for a given output, staying within the current limits of that shunt.
3. Switch the Product output terminals to **Operate**.
4. Follow the instructions provided on the Product display and Table 5-7 to adjust the Product output for the calibration adjustment points.
5. To adjust the Product output to the calibration adjustment points, push the **Select** softkey and use **0,0,0**, and **0**, the rotary knob, or numeric keyboard to adjust the output to the nominal value.
6. Push the **Write** softkey to confirm the new value. To skip a calibration adjustment point where calibration has already been entered, push the **Exit** softkey.
7. Switch output terminals to **Standby**.
8. Repeat steps 1 through 7 for Current MOD#2 and Current MOD#3.

**Table 5-7. AC Current Modulation Function (Current MOD#x)**

Nominal Value[A]	Set Limits[A]	Range [A]
30 m	10 $\mu$ A	300 mA
300 m	15 $\mu$ A	300 mA
300 m	30 $\mu$ A	1
1	50 $\mu$ A	1
1	100 $\mu$ A	2
2	100 $\mu$ A	2
2	200 $\mu$ A	5
5	250 $\mu$ A	5
5	500 $\mu$ A	10
10	500 $\mu$ A	10
10	1 mA	30
30	1.5 ma	30

### **DC Voltage from the Current Outputs Calibration Adjustment**

To adjust the calibration of dc voltage from the current outputs:

1. Select **Low voltage DC#1** from the Calibration Menu.
2. Push the **Select** softkey to confirm.
3. Switch the Product output terminals to **Operate**.
4. Follow the instructions provided on the Product display and Table 5-8 to adjust the Product output for the calibration adjustment points.
5. To adjust the Product output to the calibration adjustment points, push the **Select** softkey and use **0**, **0**, **0**, and **0**, the rotary knob, or numeric keyboard to adjust the output to the nominal value.
6. Push the **Write** softkey to confirm the new value. To skip a calibration adjustment point where calibration has already been entered, push the **Exit** softkey.
7. Switch output terminals to **Standby**.
8. Repeat steps 1 through 6 for Low voltage DC#2 and Low voltage DC#3.
9. Disconnect the reference multimeter from the Product.

**Table 5-8. Voltage from Current DC Function (Voltage DC#x)**

<b>Nominal Value [V]</b>	<b>Set Limits [V]</b>	<b>Range [V]</b>
20 m	4 $\mu$ V	20 mV
330 m	40 $\mu$ V	330 mV
5	400 $\mu$ V	5

### **Meter Calibration Adjustment**

The built-in meter calibration adjustment consists of the calibration of the 10 V dc voltage range, 20 mA dc current range and 10 kHz frequency range.

A reference calibrator of higher precision class (Fluke 5502A or 5522A) should be used to adjust the calibration of the built-in meter. See Table 5-9.

### **10 V DC Voltage Range Calibration Adjustment**

To adjust the calibration of the 10 V dc range:

1. Select **Meter** from the Calibration Menu.
2. Push the **Select** softkey to select 0 V as the first calibration adjustment point.
3. Place a short on Product input terminals METER INPUT V - COM.
4. The display shows the calibration adjustment point. Leave the value at 0.000 and push the **Write** softkey.
5. Select the 10 V calibration adjustment point.
6. Connect an external 10 V dc to the Product input terminal METER INPUT V-COM inputs. The exact value can be measured by the parallel reference multimeter if necessary.
7. Adjust the main value on the display. It should be equal to the value on the reference calibrator or as measured by the reference multimeter. Use **0.0**, **0**, and **0**, the rotary knob, or numeric keyboard to adjust output to the nominal value.
8. Push the **Write** softkey to confirm the new value.

### **20 mA DC Current Range Calibration Adjustment**

To adjust the 20 mA dc current range:

1. Select **Meter** from the Calibration Menu.
2. Push the **Select** softkey to select 0 mA as the first calibration adjustment point.
3. Place a short on the Product input terminals METER INPUT mA - COM.
4. The display shows the calibration adjustment point. Leave value 0.000 and push the **Write** softkey.
5. Select the 20 mA calibration adjustment point.
6. Connect the reference calibrator current output to the Product input terminals METER INPUT mA - COM. The exact value of the reference calibrator should be measured by connecting the reference multimeter in series with this measurement.
7. Adjust the main value on the display. It should be equal to the value on the reference calibrator or as measured by the reference multimeter. Use **0.0**, **0**, and **0**, the rotary knob, or numeric keyboard to adjust the output to the nominal value.
8. Push the **Write** softkey to confirm the new value.

### 10 kHz Frequency Range Calibration Adjustment

To adjust the calibration of the 10 kHz current range:

1. Select **Meter** from the Calibration Menu.
2. Select calibration adjustment point 10 kHz.
3. Connect external AC voltage 10 kHz (voltage between 5 V to 10 V) to the Product input terminals METER INPUT V-COM. If the Fluke 5502A is used, the frequency value should be measured by the reference multimeter in parallel with the 6003A meter. The 5522A frequency specification is adequate for this calibration adjustment without requiring this parallel measurement.
4. Adjust the main value on the display. It should be equal to the value on the reference calibrator or as measured by the reference multimeter. Use **0.0**, **0**, and **0**, the rotary knob, or numeric keyboard to adjust the output to the nominal value.
5. Push the **Write** softkey to confirm the new value.

Table 5-9. Multimeter (Meter)

Nominal Value [-]	Set Limits [-]	Range [-]
0 V	50 $\mu$ V	10 V
10 V	200 $\mu$ V	10 V
0 mA	50 nA	20 mA
20 mA	500 nA	20 mA
10 kHz	200 mHz	10 kHz



## Maintenance

The Product is cooled by variable-speed fans. To get the most reliable performance, ensure proper air flow for the Product.

### Caution

To guarantee correct operation of the Product:

- Do not block the vent openings located at the rear bottom panels.
- Do not operate the instrument in a dusty environment. Inspect and clean all vent openings at least once a month.
- Switch the Product and off by the mains switch located at the rear panel.
- Do not connect the Product to any voltage other than set by the voltage selector.
- Do not operate the Product in dusty environment. Use only in a clean laboratory.
- Do not let liquids enter the Product through the vent openings.
- Do not use the Product outside its operational temperature range.
- Ensure that all cables are in good condition.
- Use banana plugs that make a firm, secure connection to the Products output binding posts. This is especially true for the current terminals, which can output 30 A and cause self-heating with loose fitting plugs.
- Inspect the output binding posts prior to use. Repair broken or loose output binding posts before use.
- When possible, use the setup menu to ground Lo output terminals (GndU On, GndI On).
- Do not overload the output by leaving the Product switched on with the load connected for a long time, especially on 30 A current range and 140 V and 280 V voltage ranges.
- If instruments to be calibrated are not connected to the Product output terminals with the original test cables, ensure that cables suitable for the calibration adjustment voltage and current are used. Maximum output voltage can reach 600 V ac and the maximum output current can reach 30 A ac.
- Do not output greater than 30 A in the High I mode without the use of the 90 A adapter. A single 4 mm banana plug cannot carry more than 30 A.

### Regular Maintenance

The Product does not require special maintenance of electrical or mechanical parts. Inspect the output binding posts for wear and any loose connections. The case and the display can be cleaned by a microfiber cloth rag moistened with alcohol.

The Product should be verified at the recommended yearly interval.

### Clean the Product

For general cleaning, first disconnect all power input and signal cables. Wipe the Product with a soft cloth dampened with water or a non-abrasive mild cleaning solution that does not harm plastics.

#### Caution

**To prevent damage to the Product, do not use aromatic hydrocarbons or chlorinated solvents for cleaning. They can damage the materials used in the Product.**



### Fuse Replacement

There are two user-replaceable fuses in the Product, the mains power cord fuse and the multimeter fuse.

To replace the mains fuse:

1. Switch off the Product.
2. Remove the mains power cord from the mains connector at the rear panel.
3. Insert a flat-head screwdriver into the opening that is on the mains voltage selector and pull out the fuse holder.
4. Remove the fuse and replace it with new fuse of the correct rating. See Table 5-10 and Figure 5-4.
5. Replace the fuse holder.
6. Replace the mains power cord.

Table 5-10. Line Voltage Selection Fuses

115 V Mains Setting	230 V Mains Setting
 T20AL 250 V	 T10AL 250 V

To replace the multimeter fuse:

1. Remove any connections from the multimeter inputs.
2. Insert a flat-head screwdriver into the multimeter fuse holder and unscrew it until it can be pulled out.
3. Remove the fuse and replace it with new fuse of the same rating, T100 mA/250 V.
4. Replace the fuse holder.

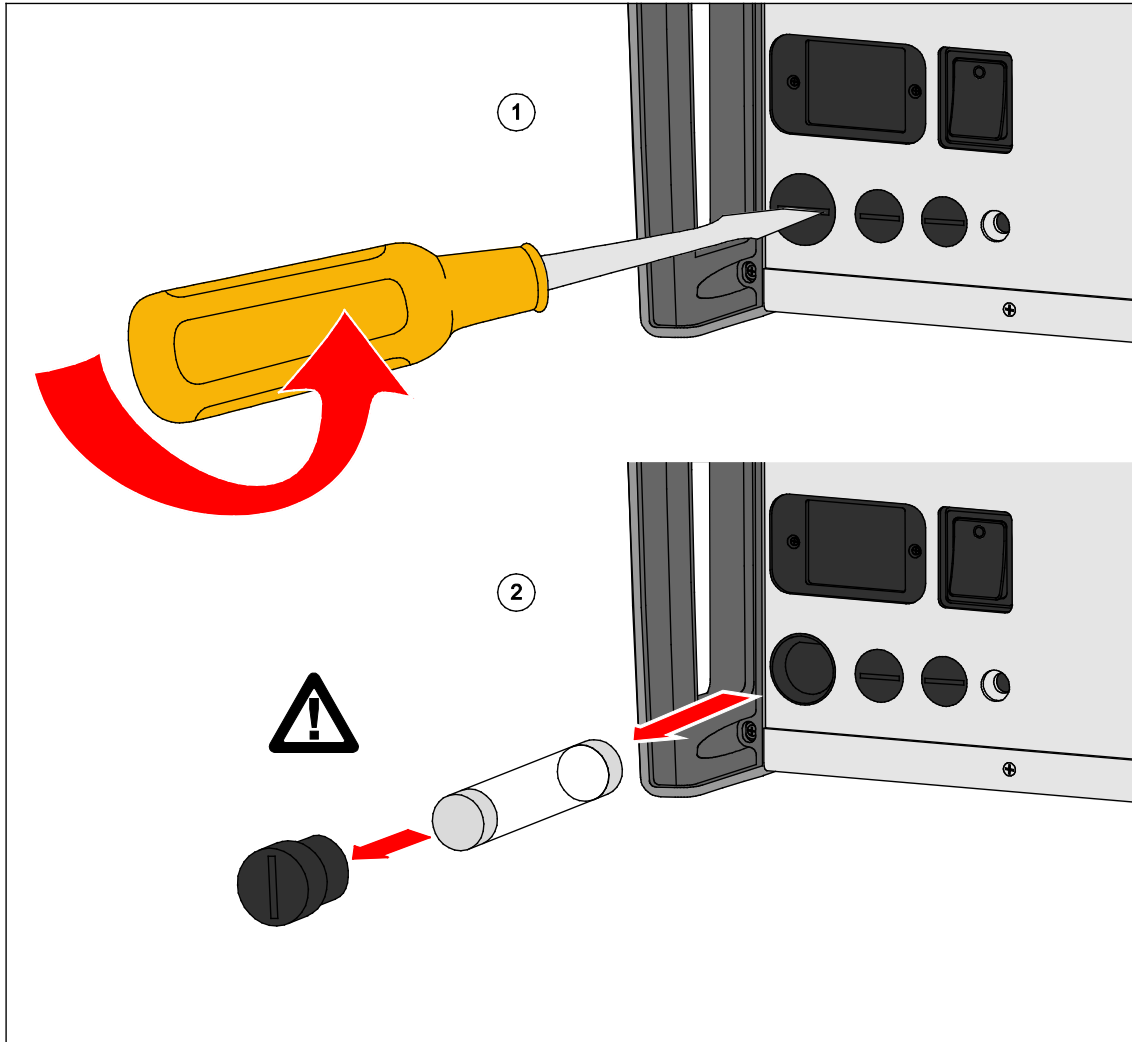

Figure 5-4. Fuse Replacement

hoa119.eps

### **In Case of Failure**

If the Product is not working correctly and you have gone through the verification, calibration adjustment, and maintenance procedures, contact the manufacturer. See *Contact Fluke Calibration* for more information

When the Product behaves differently than expected, check:

- Mains voltage out of tolerance limits or unstable.
- Wrong grounding of the measurement circuit (bad connection of the ground terminal of the mains outlet, or several ground connections causing ground loops).
- Proximity to external sources with high-electromagnetic fields, conducted through the mains power supply or propagated by the electromagnetic field.
- Strong electrostatic or electromagnetic field that can cause major instability during calibration adjustment.

### **User-Replaceable Parts**

The Product contains no user-replaceable or serviceable parts. Product documentation can be ordered. See *Contact Fluke Calibration* for more information.

**Table 5-11. User Documentation**

<b>Fluke Documentation</b>	<b>Fluke Part Number</b>
6003A User Documentation on CD: <ul style="list-style-type: none"> <li>• <i>6003A Operators Manual</i></li> <li>• <i>6003A Programmers Manual</i></li> </ul>	4406558
<i>6003A Safety Information</i>	4406535

# **Chapter 6**

## **Error Messages**

### **Introduction**

If an error occurs during Product operation or control, an error message is shown on the display. Errors can be caused by:

- Incorrect control that uses the front panel, (for example, attempts to force a prohibited mode, such as setting an out-of-range value, overloading of output terminals)
- Incorrect control using GPIB or USB interface.
- Product fault.

These messages are shown in Table 6-1. All error messages are shown in a frame that overlaps the main screen.

Table 6-1. Error Messages

ID	Error message	Description
-430	Deadlocked.	Remote interface error. A command was received that generates too much data to fit into the output buffer and the output buffer is full. Command execution continues but all data are lost.
-420	Unterminated.	Remote interface error. The Product was addressed to talk but a command has not been received which sends data to the output buffer.
-410	Interrupted.	Remote interface error. A command was received which sends data to the output buffer, but the output buffer contained data from a previous command. The output buffer is cleared when power has been off, or after reset command has been executed.
-363	Input buffer overrun	Remote interface error.
-220	Invalid parameter	Remote interface error. An invalid character string was received. Check to see if you have enclosed the character string in single or double quotes and that the string contains valid ASCII character.
-140	Character data	Remote interface error. Received command does not contain valid character parameter.
-120	Numeric data	Remote interface error. Received command does not contain valid numeric parameter.
-110	Command header	Remote interface error. Received command is not valid.
501	Eeprom write.	Eeprom write failed.
502	Eeprom read.	Eeprom read failed.
503	Eeprom error.	Eeprom data lost. Check calibration data.
701,704	Output overload	Output signal over specified limits. Decrease signal level or decrease the load.
703	High temperature	Calibrator power stage overheated. Disconnect external load. Ambient temperature is too high or forced ventilation holes are blocked.
705	Input overload	Input signal over specified limits. Decrease signal level.
706	Current output overload	Current output terminals overloaded. Decrease signal level or decrease the load.
707	Voltage output overload	Voltage output terminals overloaded. Decrease signal level or decrease the load.
722	Unexpected crossing.	Error in internal communication.

**Table 6-1. Error Messages (cont.)**

ID	Error message	Description
721	Unknown function.	Error in internal communication.
730, 731	Calibrator not ready	Error in internal communication.
732	Internal cpu RESET	Calibrator will be restarted.
743	Interface receive	Error in internal communication.
745	Internal CPU timeout	Error in internal communication.
746, 747, 748	Slave error	Error in internal communication.
750	Harmonic U#1 over range	Amplitude of harmonic signal on voltage channel #1 is too high. Reduce amplitudes of individual harmonic components.
751	Harmonic U#2 over range	Amplitude of harmonic signal on voltage channel #2 is too high. Reduce amplitudes of individual harmonic components.
752	Harmonic U#3 over range	Amplitude of harmonic signal on voltage channel #3 is too high. Reduce amplitudes of individual harmonic components.
753	Harmonic I#1 over range	Amplitude of harmonic signal on current channel #1 is too high. Reduce amplitudes of individual harmonic components.
754	Harmonic I#2 over range	Amplitude of harmonic signal on current channel #2 is too high. Reduce amplitudes of individual harmonic components.
755	Harmonic I#3 over range	Amplitude of harmonic signal on current channel #3 is too high. Reduce amplitudes of individual harmonic components.

