

# Programmable AC Power Source

APS-7000 Series

---

## USER MANUAL

GW INSTEK PART NO. 82PS-71000MA1



ISO-9001 CERTIFIED MANUFACTURER

**GW INSTEK**

This manual contains proprietary information, which is protected by copyright. All rights are reserved. No part of this manual may be photocopied, reproduced or translated to another language without prior written consent of Good Will company.

The information in this manual was correct at the time of printing. However, Good Will continues to improve products and reserves the rights to change specification, equipment, and maintenance procedures at any time without notice.

**Good Will Instrument Co., Ltd.**  
**No. 7-1, Jhongsing Rd., Tucheng Dist., New Taipei City 236, Taiwan.**

# Table of Contents

<b>SAFETY INSTRUCTIONS .....</b>	<b>4</b>
<b>GETTING STARTED .....</b>	<b>8</b>
APS-7000 Series Overview .....	9
Appearance .....	13
<b>OPERATION .....</b>	<b>20</b>
Set Up .....	22
Basic Operation .....	43
Advanced Settings .....	61
Miscellaneous .....	68
Trigger .....	74
Preset Settings .....	78
Arbitrary Waveform Function .....	82
Test Mode Function .....	89
<b>REAR PANEL SIGNAL OUTPUTS .....</b>	<b>126</b>
<b>COMMUNICATION INTERFACE .....</b>	<b>131</b>
Interface Configuration .....	132
<b>FAQ .....</b>	<b>152</b>
<b>APPENDIX .....</b>	<b>153</b>
Firmware Update .....	153
APS-7000 Default Settings .....	155
APS-7000 Specifications .....	157
APS-7000 Dimensions .....	163
Declaration of Conformity .....	165
<b>INDEX .....</b>	<b>166</b>

# S SAFETY INSTRUCTIONS

This chapter contains important safety instructions that you must follow during operation and storage. Read the following before any operation to ensure your safety and to keep the instrument in the best possible condition.

## Safety Symbols

These safety symbols may appear in this manual or on the instrument.

---



Warning: Identifies conditions or practices that could result in injury or loss of life.



Caution: Identifies conditions or practices that could result in damage to the APS-7000 or to other properties.



DANGER High Voltage



Attention Refer to the Manual



Protective Conductor Terminal



Earth (ground) Terminal



Do not dispose electronic equipment as unsorted municipal waste. Please use a separate collection facility or contact the supplier from which this instrument was purchased.

## Safety Guidelines

---

### General Guideline



#### CAUTION

- Do not place any heavy object on the APS-7000.
- Avoid severe impact or rough handling that leads to damaging the APS-7000.
- Do not discharge static electricity to the APS-7000.
- Use only mating connectors, not bare wires, for the terminals.
- Do not block the cooling fan opening.
- Do not disassemble the APS-7000 unless you are qualified.

(Measurement categories) EN 61010-1:2010 specifies the measurement categories and their requirements as follows. The APS-7000 falls under category I.

- Measurement category IV is for measurement performed at the source of low-voltage installation.
- Measurement category III is for measurement performed in the building installation.
- Measurement category II is for measurement performed on the circuits directly connected to the low voltage installation.
- Measurement category I is for measurements performed on circuits not directly connected to Mains.

---

### Power Supply



#### WARNING

- AC Input voltage range: 115/230 Vac  $\pm$  15%
  - Frequency: 47~63Hz
  - To avoid electrical shock connect the protective grounding conductor of the AC power cord to an earth ground.
-

- Cleaning the APS-7000
- Disconnect the power cord before cleaning.
  - Use a soft cloth dampened in a solution of mild detergent and water. Do not spray any liquid.
  - Do not use chemicals containing harsh material such as benzene, toluene, xylene, and acetone.

Operation Environment

- Location: Indoor, no direct sunlight, dust free, almost non-conductive pollution (Note below)
- Relative Humidity: 20%~ 80%, no condensation
- Altitude: < 2000m
- Temperature: 0°C to 40°C

(Pollution Degree) EN 61010-1:2010 specifies the pollution degrees and their requirements as follows. The APS-7000 falls under degree 2.

Pollution refers to “addition of foreign matter, solid, liquid, or gaseous (ionized gases), that may produce a reduction of dielectric strength or surface resistivity”.

- Pollution degree 1: No pollution or only dry, non-conductive pollution occurs. The pollution has no influence.
- Pollution degree 2: Normally only non-conductive pollution occurs. Occasionally, however, a temporary conductivity caused by condensation must be expected.
- Pollution degree 3: Conductive pollution occurs, or dry, non-conductive pollution occurs which becomes conductive due to condensation which is expected. In such conditions, equipment is normally protected against exposure to direct sunlight, precipitation, and full wind pressure, but neither temperature nor humidity is controlled.

Storage environment

- Location: Indoor
- Temperature: -10°C to 70°C
- Relative Humidity:  $\leq 80\%$ , no condensation

Disposal



Do not dispose this instrument as unsorted municipal waste. Please use a separate collection facility or contact the supplier from which this instrument was purchased. Please make sure discarded electrical waste is properly recycled to reduce environmental impact.

## Power cord for the United Kingdom

When using the instrument in the United Kingdom, make sure the power cord meets the following safety instructions.

NOTE: This lead/appliance must only be wired by competent persons



**WARNING: THIS APPLIANCE MUST BE EARTHED**

IMPORTANT: The wires in this lead are coloured in accordance with the following code:

Green/ Yellow:	Earth
Blue:	Neutral
Brown:	Live (Phase)



As the colours of the wires in main leads may not correspond with the coloured marking identified in your plug/appliance, proceed as follows:

The wire which is coloured Green & Yellow must be connected to the Earth terminal marked with either the letter E, the earth symbol  or coloured Green/Green & Yellow.

The wire which is coloured Blue must be connected to the terminal which is marked with the letter N or coloured Blue or Black.

The wire which is coloured Brown must be connected to the terminal marked with the letter L or P or coloured Brown or Red.

If in doubt, consult the instructions provided with the equipment or contact the supplier.

This cable/appliance should be protected by a suitably rated and approved HBC mains fuse: refer to the rating information on the equipment and/or user instructions for details. As a guide, a cable of 0.75mm<sup>2</sup> should be protected by a 3A or 5A fuse. Larger conductors would normally require 13A types, depending on the connection method used.

Any exposed wiring from a cable, plug or connection that is engaged in a live socket is extremely hazardous. If a cable or plug is deemed hazardous, turn off the mains power and remove the cable, any fuses and fuse assemblies. All hazardous wiring must be immediately destroyed and replaced in accordance to the above standard.

# GETTING STARTED

This chapter describes the power source in a nutshell, including its main features and front / rear panel introduction.



<b>APS-7000 Series Overview .....</b>	<b>9</b>
Series lineup .....	9
Operating Area .....	9
Main Features .....	10
Accessories .....	11
<b>Appearance .....</b>	<b>13</b>
Front Panel .....	13
Rear Panel .....	17



## APS-7000 Series Overview

### Series lineup

The APS-7000 series consists of 2 models, the APS-7050 and the APS-7100, differing only in capacity. Note that throughout the user manual, the term “APS-7000” refers to both the APS-7050 and APS-7100, unless stated otherwise.

Model name	Max. Output Current	Power Rating	Output Voltage
APS-7050	4.2A/2.1A	500VA	0~310.0 Vrms
APS-7100	8.4A/4.2A	1000VA	0~310.0 Vrms

### Operating Area

APS-7050 Output Operating Area

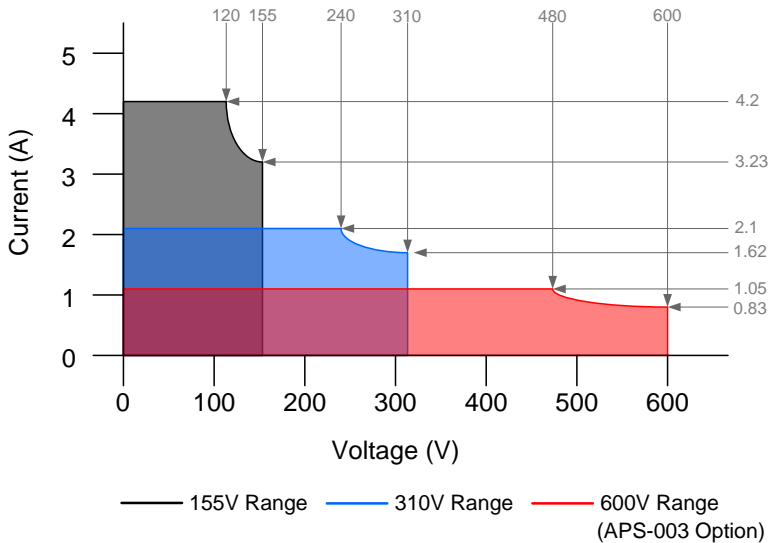

APS-7100 Output Operating Area

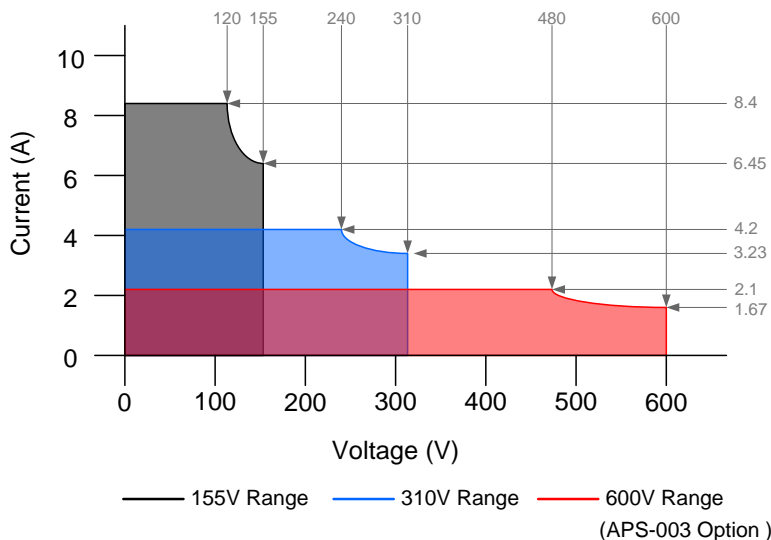

## Main Features

- Performance
- Low output ripple and noise
  - Excellent and feature-rich measurement capacity
  - Standard maximum output voltage is 310Vrms
  - Maximum output voltage and frequency of 600Vrms(APS-003 Option)/999.9Hz(APS-004 Option)

- Features
- OVP, OCP and OTP protection
  - Variable voltage, frequency and current limiter
  - Sequence and simulation function
  - Large 4.3 inch TFT panel
  - Globally adjustable power inlet not restricted by the power supply environment
  - USB interface is equipped as standard with the ability to save and recall setup files.
  - Only 88mm (2U) case height.

- Interface
- Ethernet port
  - USB host
  - RS-232 / USB CDC (optional)
  - GPIB (optional)

### Accessories

Standard Accessories	Part number	Description
	CD ROM	User manual, programming manual
	4322-30700101 (UL/CSA)	Type I Power cord (APS-7050)
	4322-B0700101 (PSE)	Type II Power cord (APS-7050)
	4300-31000101 (UL/CSA)	Type I Power cord (APS-7100)
	4300-B1000201 (PSE)	Type II Power cord (APS-7100)
	62PS-7K0SC401 x1 5302-01613001 x1	Mains terminal cover set (APS-7050)

	62PS-7K0SC701 x1	Mains terminal cover set (APS-7100)
	5302-01613001 x2	
	GTL-123	Test leads: 1x red, 1x black
Optional Capacity	Part number	Description
	APS-003	Output Voltage Capacity: 0 ~ 600Vrms
	APS-004	Output Frequency Capacity: 45 ~ 999.9Hz
Optional Accessories	Part number	Description
	GRA-423	APS-7000 rack mount kit
	APS-001	GPIB interface card
	APS-002	RS-232 / USB interface card
Download	Name	Description
	gw_aps.inf	USB driver

# Appearance

## Front Panel

APS-7050, APS-7100

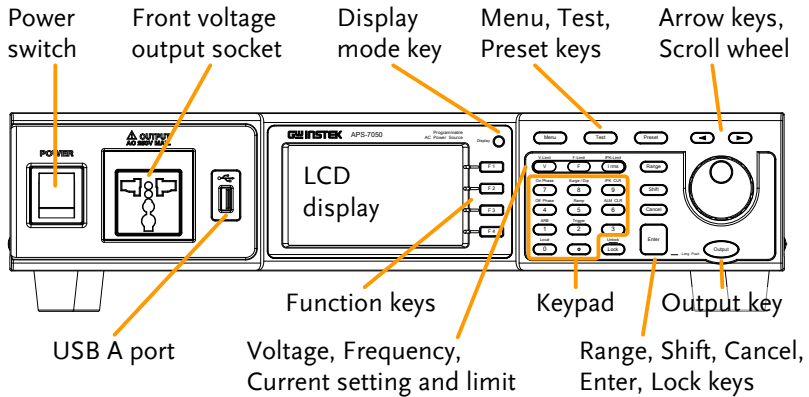

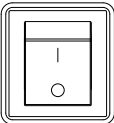
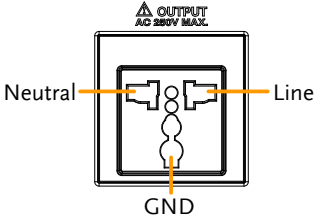







Item	Description
Power Switch	<p><b>POWER</b></p>  <p>Turns on the mains power.</p>
Front Voltage Output Socket	<p><b>OUTPUT AC 250V MAX.</b></p>  <p>Output voltage terminal using a regional universal plug. There is a Euro and a Universal regional plug.</p>

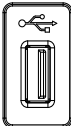



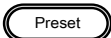



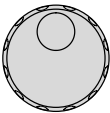

**CAUTION**

Maximum allowable output voltage and current are 250Vrms and 10Arms.

For voltages exceeding 250Vrms, please use the rear output terminal.

USB A Port		<p>The USB port is used for data transfers and upgrading software.</p>
LCD Screen		<p>Displays the measured values or menu system.</p>
Display Mode Select Key		<p>Selects between Standard mode and Simple mode.</p>
Function Keys		<p>Assigned to the functions displayed on the right-hand side of the screen.</p>
Menu Key		<p>Enters the Main menu or goes back to one of the display modes.</p>
Test Key		<p>Puts the instrument into the Sequence, Simulation and Program Control mode.</p>
Preset Key		<p>Puts the instrument into Preset mode.</p>
Arrow Keys		<p>The arrow keys are used to select the digit power of a value that is being edited.</p>
V		<p>Used for setting the output voltage.</p>
V-Limit	<p>(Shift + V)</p>	<p>Used for setting the output voltage limit value.</p>
F		<p>Used for setting the output frequency.</p>
F-Limit	<p>(Shift + F)</p>	<p>Used for setting the output frequency limit value.</p>
I rms		<p>Used for setting the maximum output current.</p>
IPK-Limit	<p>(Shift + I rms)</p>	<p>Used to set the peak output current limit value.</p>

- Range Key  Switches between the 155V, 310V and 600V ranges (the 600V range is an option).
- Scroll Wheel  Used to navigate menu items or for incrementing/decrementing values one step at a time.
- Lock Key  Locks the number pad to prevent accidentally changing panel settings.
- Unlock Key (Long press)  Disables the key lock.
- Enter Key  Confirms selections / settings
- Cancel Key  Clears entries that are made in the number entry dialog when a value is edited using the arrow keys or the scroll wheel.  
The Cancel key can also be used to cancel function setting menus or dialogs.
- Shift Key  Turns on the shift state, which enables shortcut operations.
- Output Key  Turns the output on or off.
- Number Pad  Used to enter values.
- Local Mode (Shift + 0) Switches operation back to local mode from remote mode.
- ARB Mode (Shift + 1) Sets the ARB function.
- Trigger Mode (Shift + 2) Sets the JI port trigger behavior on the rear panel.

Off Phase	(Shift + 4)	Sets the off phase for the output voltage.
RAMP	(Shift + 5)	Quick settings for Ramp control.
ALM CLR	(Shift + 6)	Clears alarms.
On Phase	(Shift + 7)	Sets the on phase for the output voltage.
Surge/Dip	(Shift + 8)	Quick settings for Surge/Dip control.
IPK CLR	(Shift + 9)	Clears peak current protection.



Rear Panel

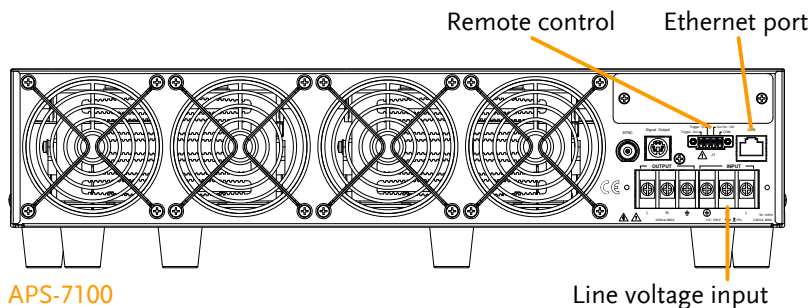
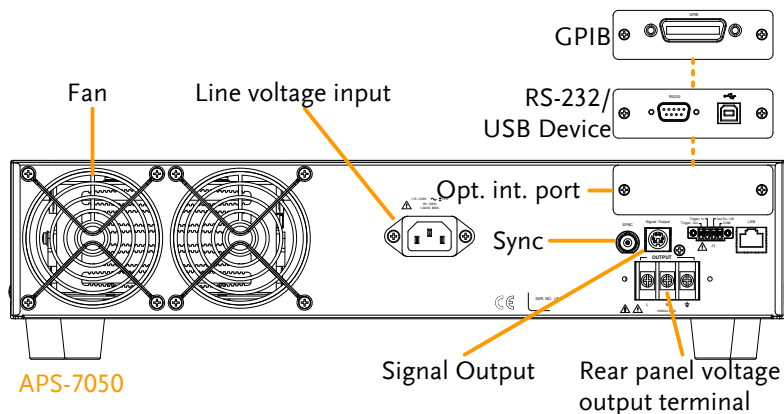

Line Voltage Input

APS-7050

Voltage Input: 115/230±15% VAC;  
Line frequency: 50Hz/60 Hz  
(Automatically switchable)

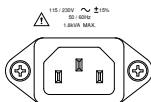

**APS-7100**

Voltage Input: 115/230±15% VAC ; Line frequency: 50Hz/60 Hz (Automatically switchable)

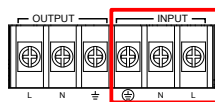

Rear Voltage Output Socket

Output voltage terminal.

**APS-7050**

**APS-7100**

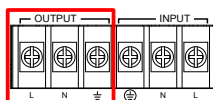
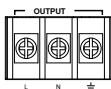

Sync Output Socket



BNC socket. This socket will output a signal of approximately 10V when the output is on.

Signal Output



Connector for monitoring PASS, FAIL and PROCESSING output signals when using the Program mode.

Remote Control

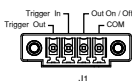

Connector for controlling the TRIGGER IN, TRIGGER OUT and OUT ON/OFF states.

Ethernet Port



The Ethernet port is used for remote control and digital monitoring from a PC.

Optional Interface Slot

Optional GPIB communication, RS-232/USB B communication.

FAN

Temperature controlled fan.

Status Bar Icons

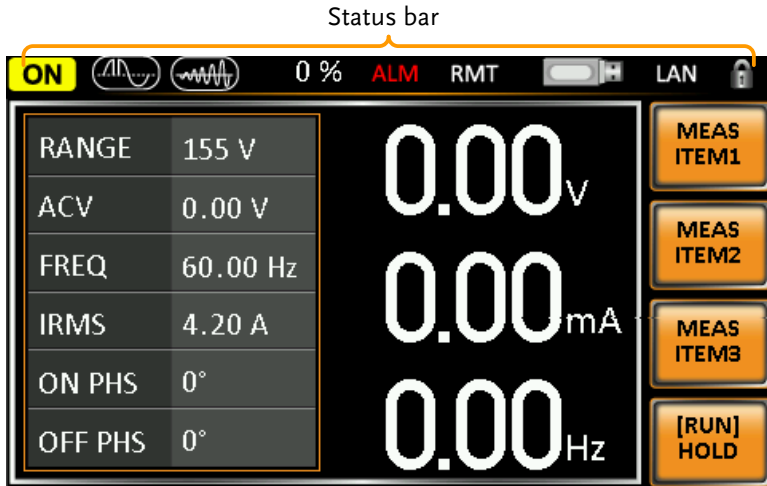

Indicates if the output is ON or OFF.



Indicates the output power as a percentage of full scale.



Indicates that the Surge/Dip function is active.



Indicates that the Ramp function is active.



The alarm icon will appear on the status bar when one of the protection functions are tripped. Applies to Over Power, Over Irms, Over Ipeak and Over Temperature protection.



Indicates that the APS-7000 is in remote mode.



Indicates that a USB drive is detected in the front panel host port.



Indicates that the LAN interface is activated.



Indicates that the panel lock is active.

# OPERATION

---

<b>Set Up</b> .....	<b>22</b>
Line Voltage Connection (APS-7100).....	22
Power Up.....	25
Output Terminals .....	26
Installing the Optional Modules .....	30
Using the Rack Mount Kit .....	32
How to Use the Instrument .....	32
Reset to Default Settings .....	37
View System Version and Build Date.....	38
LCD Configuration .....	39
USB Driver Installation .....	40
<b>Basic Operation</b> .....	<b>43</b>
Setting the Voltage Range.....	43
Setting the Voltage Limit .....	44
Setting the Output Voltage.....	45
Setting the Frequency Limit .....	47
Setting the Output Frequency.....	48
Setting the Peak Current Limit .....	49
Setting the Current RMS Level.....	52
Setting the On/Off Phase .....	55
Alarm Clear.....	56
Display Modes.....	57
Panel Lock .....	59
Turning the Output On .....	60
<b>Advanced Settings</b> .....	<b>61</b>
Surge/Dip Control .....	61
Ramp Control.....	65
<b>Miscellaneous</b> .....	<b>68</b>
T Ipeak, hold .....	68
Power ON Output.....	70

---

Buzzer.....	71
SCPI Emulation.....	72
Program Timer Unit.....	73
<b>Trigger .....</b>	<b>74</b>
Trigger Control Settings.....	74
<b>Preset Settings.....</b>	<b>78</b>
Save Preset Settings to Local Memory.....	78
Load Preset Settings to Local Memory.....	79
Manage Preset Settings.....	80
<b>Arbitrary Waveform Function .....</b>	<b>82</b>
ARB Mode Overview.....	83
Selecting an ARB Waveform.....	86
<b>Test Mode Function.....</b>	<b>89</b>
Simulate Mode Overview .....	91
Simulate Settings .....	95
Save a Simulation to Local Memory.....	98
Recall a Simulation from Local Memory .....	98
Manage Simulation Settings.....	99
Running a Simulation .....	101
Sequence Mode Overview .....	103
Sequence Settings.....	107
Save a Sequence to Local Memory.....	111
Recall a Sequence from Local Memory .....	111
Manage Sequence Settings.....	112
Running a Sequence .....	114
Program Mode Overview .....	116
Save a Program to Local Memory .....	123
Recall a Program from Local Memory.....	123

## Set Up

### Line Voltage Connection (APS-7100)

---

**Background**                      The APS-7100 is equipped with an input power terminal that can accept 115V/230V  $\pm$  15%. To connect or replace the power cord (GW Instek part number: APS-7100: 4300-31000101, use the procedure below:

---



The following procedure should only be attempted by competent persons.

Ensure the AC power cord is not connected to power.

---

**Removal**                      1. Turn off the power switch.

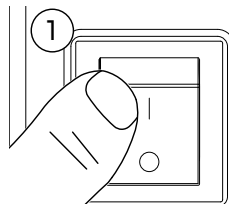

**APS-7100**                      2. Unscrew the power cord protective sheath on the rear output socket.

3. Remove the 2 screws holding the power cord cover and remove.

APS-7100

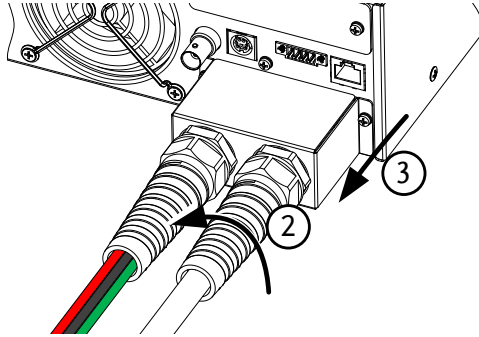

4. Remove the AC power cord wires.

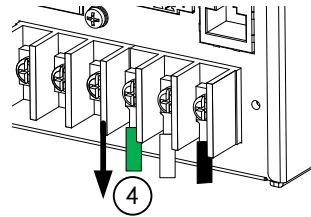

The power line inputs for the APS-7100 are on the outer cluster of terminals.

The terminals to the inner of the panel are the rear panel outputs.

Installation

1. Connect the AC power cord wires to the AC input terminals.
  - White/Blue → Neutral (N)
  - Green/Green-yellow → GND (⊥)
  - Black/Brown → Line (L)

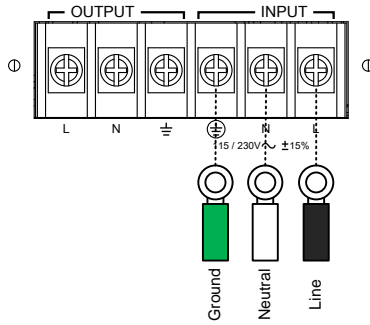

2. Re-install the power cord cover.
3. Screw the power cord sheath back onto the cover.

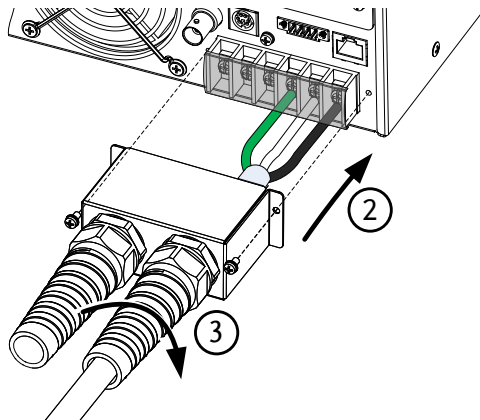



## Power Up

### Steps

1. Socket type: Connect the power cord to the rear panel socket.

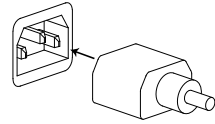

Input Power Terminal: Page 22  
 Connect the power cord to the input power terminals.

2. Press the POWER key. The splash screen will appear momentarily before the continuous mode screen appears with the settings loaded.

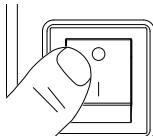

 **CAUTION**

The power supply takes around 10 seconds to fully turn on and shutdown.

Do not turn the power on and off quickly.

## Output Terminals

**Background** The output terminals can be output from either the front panel or from the rear panel. The outputs are limited to 4.2A/2.1A (APS-7050) or 8.4A/4.2A(APS-7100).

**Supported plugs** Multi-region terminal Socket  
Supported Standards  
IEC, North America, Japan.  
EURO CEE type universal plug

 **WARNING** Dangerous voltages. Ensure that the power to the instrument is disabled before handling the power supply output terminals. Failing to do so may lead to electric shock.

 **CAUTION** For the front panel output, the maximum output voltage is 250VAC and current is 10A.

- Front Panel Output Connection**
1. The front panel has a multi-region power socket depending on the socket type.
  2. Insert the plug from the DUT into the socket.

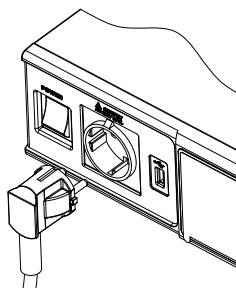

EURO CEE socket

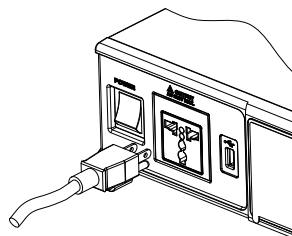

IEC North America, Japan

3. Turn the power on. The AC power supply is now ready to power the DUT.

#### Rear Panel Output Connection

The rear panel output is used to supply higher power DUTs. The rear panel output connection is similar to the universal rear panel line input connection on the APS-7100.

1. Disconnect the unit from the mains power socket and turn the power switch off.
2. Unscrew the power cord protective sheath.
3. Remove the 2 screws holding the power cord cover and remove.

#### APS-7050

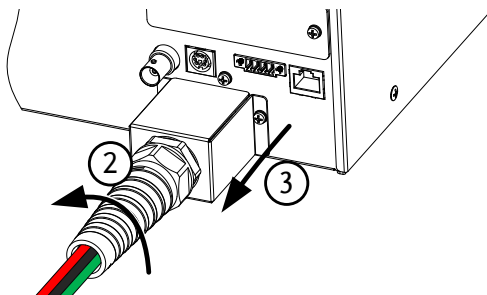

#### APS-7100

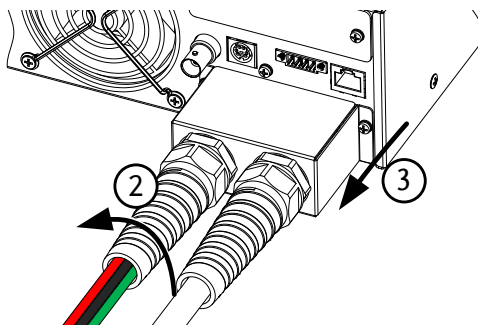



**CAUTION**

For the APS-7100, there is a single bank for the input and output terminals. Ensure the correct terminals are connected. The APS-7050 only has a single bank of output terminals on the rear panel.

**Installation**

4. Connect the output AC power cord wires to the AC output terminals.

- Black → Neutral (N)
- Green → GND (⊥)
- Black → Line (L)

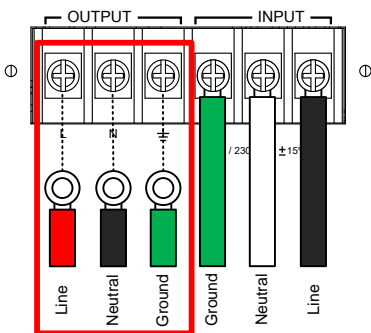

APS-7100 shown. The input terminals are already connected and shows which output terminals are to be connected.

5. Re-install the power cord cover.
6. Screw the power cord sheath back onto the cover.

APS-7100

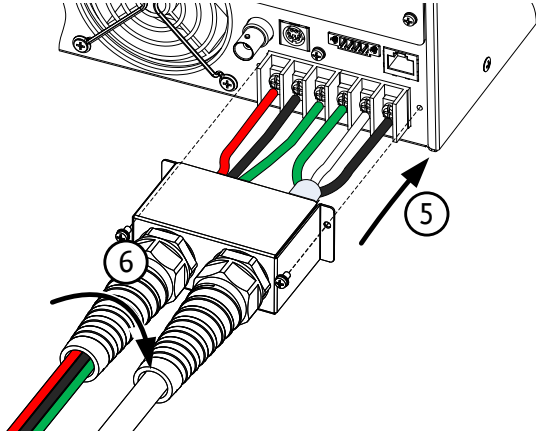

APS-7050

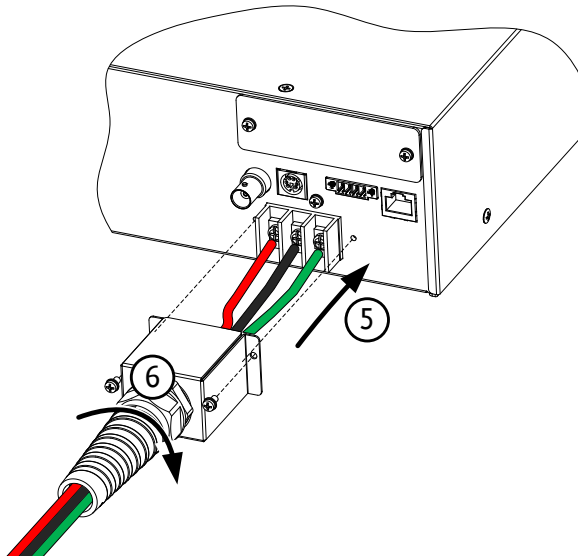



7. Turn the power on. The AC power supply is now ready to power the DUT.

## Installing the Optional Modules

**Background** There are a number of optional modules that can be installed for remote control or for the SCPI compatibility modes.

**Optional Modules**    APS-001    GPIB Interface card  
                                  APS-002    RS-232/USB interface card

 **WARNING** Dangerous voltages. Ensure that the power to the instrument is disabled before handling the power supply output terminals. Failing to do so may lead to electric shock.

 **CAUTION** Ensure the power is off before installing any of the optional modules.

**Installation**    1. Turn off the power switch.

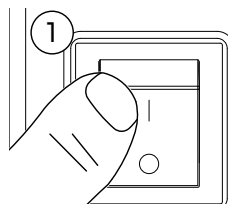

2. Unscrew the two screws holding the options panel plate.

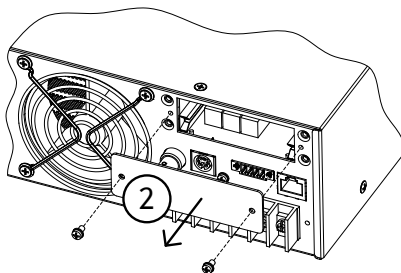

- Slide the module PCB onto the rails on the inside of the module slot.
- Secure the module with the screws that were removed from step 2.

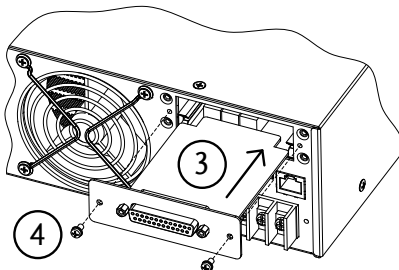

- The module will be recognized upon startup.

## Using the Rack Mount Kit

---

### Background

The APS-7000 series has an optional Rack Mount Kit (GW Instek part number: GRA-423). The APS-7050 and APS-7100 are designed to fit into a 2U rack height. Please see your distributor for further rack mount details.

### Rack mount diagram

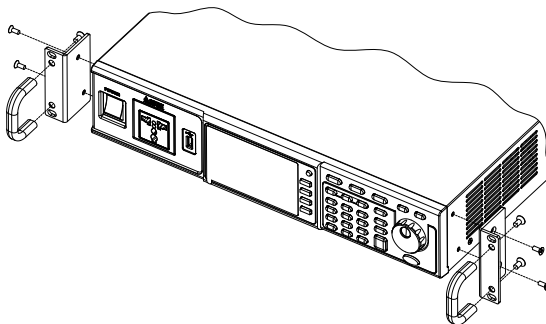

### CAUTION

Ensure adequate ventilation is provided when using the rack mount. Ensure at a gap of at least 50mm is given for the side air intakes. Failure to do so may cause the instrument to overheat.

## How to Use the Instrument

---

### Background

The APS-7000 AC power supplies generally use the scroll wheel, arrow keys and Enter keys to edit numerical values or to select menu options.

Menu navigation is performed using the menu keys and function keys on the front panel.

The following section will explain some of these concepts in detail.

---



Selecting Menu Items

1. Turn the scroll wheel to select parameters in menus and lists. The selected parameter will be highlighted in orange. The scroll wheel is also used to increment/decrement setting values.

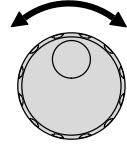

2. Press the Enter key to edit the parameter or to enter the selected menu.



Example

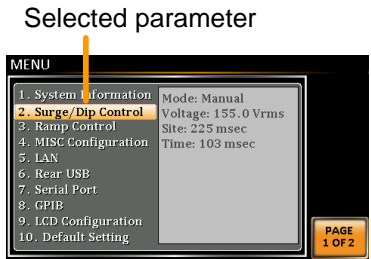

The following is an example of the menu list that appears when the Menu key is pressed.

Using the Keypad to edit parameter values

When editing a value the keypad can be used to directly enter the desired value.

1. Type the value of the parameter using the keypad.

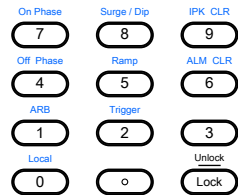

2. Press the Enter key to confirm the edit.



Example

Parameter

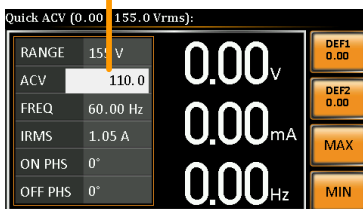

Using the Arrow Keys and Scroll Wheel to edit parameter values

Use the arrow keys to select a digit power and then use the scroll wheel to edit the value by that power.

1. Use the arrow keys to move the cursor to the digit of the desired power.
2. Turn the scroll wheel to edit the value by the resolution of the selected digit.

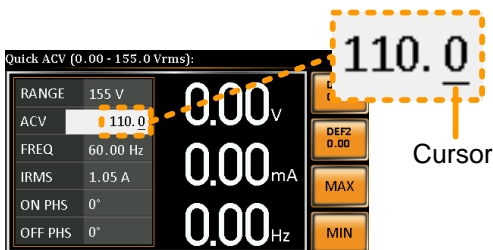
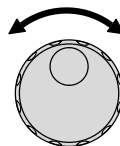

3. Repeat the steps above for all the relevant digits.
4. Press the Enter key to confirm the edit.





Note

By default the cursor starts at the lowest power digit.

Using the onscreen keyboard

The onscreen keyboard is only used in the Program Mode. The screenshot below is an example of the onscreen keyboard.

On screen keyboard



Entered characters

Using the Function Keys

The function keys are quick settings keys, the function of which depends on the current menu or operation.

1. Press the function key that corresponds to the setting directly to its left.
2. The setting or parameter is immediately executed.

Function keys

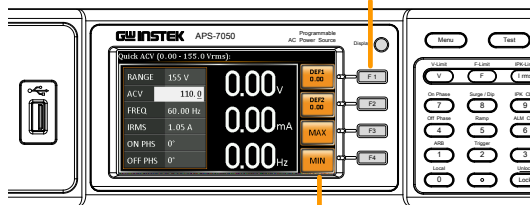

Corresponding quick settings

3. Repeat the steps above for all the relevant digits.

## Reset to Default Settings

---

**Background** The default settings can be restored from the Menu key settings. See page 155 for the default factory settings.

---

- Steps**
1. Press the *Menu* key. The Menu settings will appear on the display. 
  2. Use the scroll wheel to go to item 10, *Default Setting*.
  3. Press *Enter* x2 to restore the default settings.

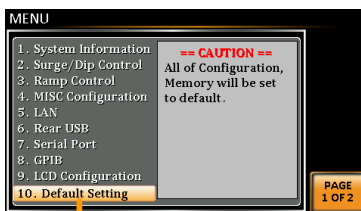

Default settings

## View System Version and Build Date

**Background**                      The Menu>System Information setting displays the serial number and version number.

- Steps**
1. Press the Menu key. The Menu setting will appear on the display. 
  2. The system information should now be listed on the display.

If not, use the scroll wheel to go to item 1, *System Information*.

### System Information

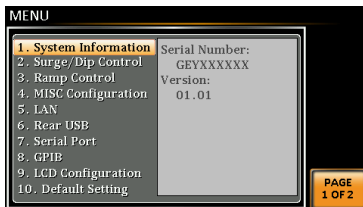



## LCD Configuration

---

**Background**                      The LCD Configuration setting sets the brightness, contrast and saturation level of the LCD display.

---

- Steps**
1. Press the *Menu* key. The Menu settings will appear on the display. 
  2. Use the scroll wheel to go to item 9, *LCD Configuration* and press *Enter*.
  3. Set the brightness, contrast and saturation.
    - Contrast(%)    1 ~ 100% (Default=50%)
    - Brightness(%) 1 ~ 100% (Default=50%)
    - Saturation(%) 1 ~ 100% (Default=50%)

- Exit**
4. Press *Exit*[F4] to exit from the Ramp Control settings. 

- Default Settings**
5. Press *Default*[F3] to set all the LCD settings to 50%.

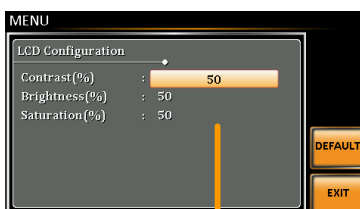

Default settings

LCD settings

## USB Driver Installation

**Background** If the USB Type B interface is to be used for remote control, the USB driver needs to be installed.



**Note**

The USB driver, *GW\_APS.inf*, is located on the CD Rom that accompanied this user manual. Alternatively the driver can be downloaded from the GW Instek website.

For information on the USB interface, see page 132.

**Steps** 1. Connect the rear panel USB -B port on the APS-7000 to the PC using a USB Type A to B cable.

2. Go the Windows Device Manager.

For Windows 7:

**Start > Control Panel > Hardware and Sound > Device Manager**

3. The APS-7000 will be located under *Other Devices* in the hardware tree. Right-click the *APS-70XX* and choose *Update Driver Software*.

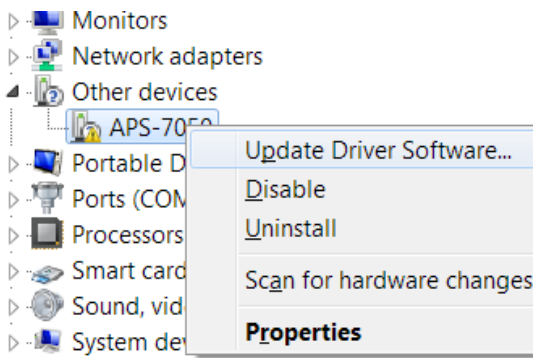



4. From the hardware wizard choose *Browse my computer driver software*.

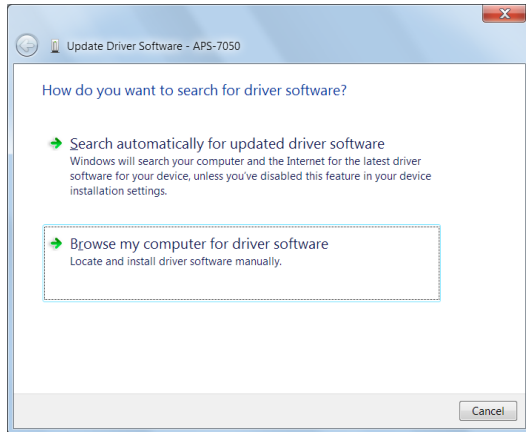

5. Set the file path to the location of the USB driver, click Next and finish the driver installation.

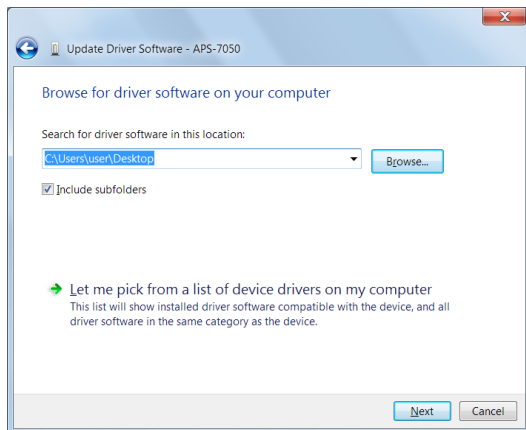

6. In APS-7000 will now be located in the *Ports* node of the hardware tree in the Windows Device Manager if the driver installation was successful.

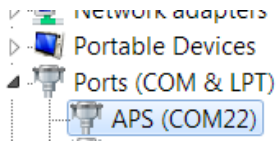

## Basic Operation

This section describes the basic operations required to operate the power supply.

- Setting the Voltage Range → from page 43
- Setting the Voltage Limit → from page 44
- Setting the Output Voltage → from page 45
- Setting the Frequency Limit → page 47
- Setting the Output Frequency → page 48
- Setting the Peak Current Limit → from page 49
- Setting the Current RMS Level → from page 52
- Setting the On/Off Phase → from page 55
- Clearing the Alarm → from page 56
- Setting the Display mode → from page 57
- Panel lock → from page 59
- Turning the Output on/off → from page 60

Before operating the power supply, please see the Getting Started chapter, page 8.

### Setting the Voltage Range

---

Background	The Range setting determines the general outlet voltage range. The ranges available correspond to common mains output voltage standards.
------------	--

---

Steps

1. Press Range to access the Range menu.

A button with the word "Range" inside a rounded rectangular border.

- Set the voltage range with the scroll wheel or with the F1 ~ F4 soft-keys.

Range	AUTO, 600V(option), 310V, 155V
-------	--------------------------------

Soft-keys	AUTO, 600V(option), 310V, 155V
-----------	--------------------------------

- Press Enter to confirm the Range setting.

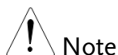
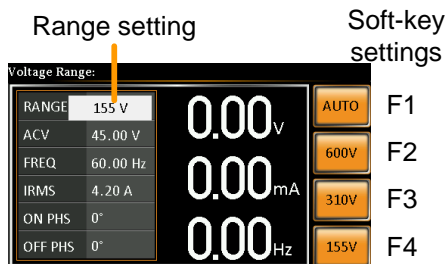

Note

If the range is changed from 155V to 600V, the Irms and IPK values will automatically be changed to a lower value. If the range is changed from 600V to 155V, the Irms and IPK values remain the same.

If the voltage range is changed when the output is on, the output will be automatically turned off.

## Setting the Voltage Limit

Background

Setting the voltage limit allows the output voltage to be set to any level within the voltage limit (V Limit) range.

Steps

- Press *Shift* + *V* to access the Volt Limit menu.

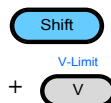

- Set the voltage limit with the scroll wheel or with the F3 ~ F4 soft-keys. The MAX and MIN soft-keys set the limit to the maximum and minimum, respectively.

---

Range      10% of full range ~ full range

---

Soft-keys    MAX, MIN

---

- Press *Enter* to confirm the voltage limit setting.

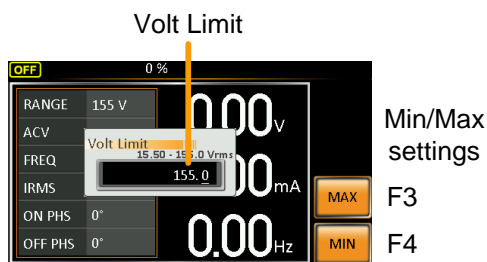

Note

Each voltage range (155V, 310V, 600V) has an independent voltage limit.

## Setting the Output Voltage

The voltage setting sets the voltage level of the power supply.

---

Background      Before setting the power supply voltage level, set the voltage range and voltage limit.

---

Steps

- Press the V key. The ACV parameter will be editable.



- Set the voltage with the scroll wheel/keypad or with the F1 ~ F4 soft-keys.

---

Range      0 volts ~ full range

---

Soft-keys    DEF1, DEF2, MAX, MIN

---

3. Press *Enter* to confirm the voltage setting.

**Preset Settings**

The DEF1 and DEF2 preset settings are user defined settings. By default they are set to 0.00 volts. The MAX and MIN soft-keys set the voltage to the maximum and minimum, respectively.

4. Press the *V* key and set the desired voltage with the scroll wheel/keypad.

Range      0 volts ~ full scale of voltage range

5. Press and hold the DEF1 or DEF2 soft-key until "Saved to DEF1/2" is displayed. This will save the voltage setting to the DEF1 or DEF2 soft-key.



**Note**

Trying to set the voltage outside of the voltage limit/range will result in a voltage setting error being displayed on the screen.

The voltage level can be set when the output is on.

**Example**

<p><b>Voltage setting</b></p>	<p><b>Preset voltage settings</b></p> <table border="0"> <tr> <td>DEF1 0.00</td> <td>F1</td> </tr> <tr> <td>DEF2 0.00</td> <td>F2</td> </tr> <tr> <td>MAX</td> <td>F3</td> </tr> <tr> <td>MIN</td> <td>F4</td> </tr> </table>	DEF1 0.00	F1	DEF2 0.00	F2	MAX	F3	MIN	F4
DEF1 0.00	F1								
DEF2 0.00	F2								
MAX	F3								
MIN	F4								

## Setting the Frequency Limit

**Background**                      Setting the frequency limit allows the frequency output to be set to any level within the limit range.

**Steps**                              1. Press *Shift* + *F* to access the Freq Limit menu.

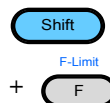

2. Set the frequency limit with the scroll wheel/keypad or with the F3 ~ F4 soft-keys. The MAX and MIN soft-keys set the frequency limit to the maximum and minimum, respectively.

Range                      45.00 ~ 500.0Hz (999.9Hz option)

Soft-keys                  MAX, MIN

3. Press *Enter* to confirm the limit setting.

**Example**

**Freq Limit**

Min/Max settings  
MAX    F3  
MIN    F4

## Setting the Output Frequency

The frequency setting sets the frequency of the output.

---

Background	Before setting the frequency, set the frequency limit.
------------	--

---

- |           |  |   |                                  |           |                      |
|-----------|--|---|----------------------------------|-----------|----------------------|
| Steps     | 1. Press the <i>F</i> key. The <b>FREQ</b> parameter will be editable.   |  |                                  |           |                      |
|           | 2. Set the frequency with the scroll wheel/keypad or with the F1 ~ F4 soft-keys.   |   |                                  |           |                      |
|           | <table> <tr> <td>Range</td> <td>45.00 ~ 500.0Hz (999.9Hz option)</td> </tr> <tr> <td>Soft-keys</td> <td>DEF1, DEF2, MAX, MIN</td> </tr> </table> | Range   | 45.00 ~ 500.0Hz (999.9Hz option) | Soft-keys | DEF1, DEF2, MAX, MIN |
| Range     | 45.00 ~ 500.0Hz (999.9Hz option)   |   |                                  |           |                      |
| Soft-keys | DEF1, DEF2, MAX, MIN   |   |                                  |           |                      |
- 
3. Press *Enter* to confirm the frequency setting.
- 

Preset Settings	The DEF1 and DEF2 preset settings are user defined settings. By default they are set to 50.00Hz and 60.00Hz, respectively. The MAX and MIN soft-keys set the frequency to the maximum and minimum, respectively.
-----------------	--

- |  |                                  |                                  |  |
|--|----------------------------------|----------------------------------|--|
| 4. Press the <i>F</i> key and set the desired frequency with the scroll wheel/keypad.  |                                  |                                  |  |
| <table> <tr> <td>Range</td> <td>45.00 ~ 500.0Hz (999.9Hz option)</td> </tr> </table>   | Range                            | 45.00 ~ 500.0Hz (999.9Hz option) |  |
| Range  | 45.00 ~ 500.0Hz (999.9Hz option) |                                  |  |
| 5. Press and hold the DEF1 or DEF2 soft-key until "Saved to DEF1/2" is displayed. This will save the frequency setting to the DEF1 or DEF2 soft-key. |                                  |                                  |  |

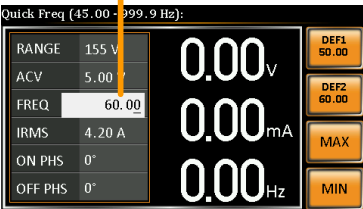

Example

	Frequency setting	Preset frequency settings								
		<table border="0" style="width: 100%;"> <tr><td style="text-align: center;">DEF1 50.00</td><td style="padding-left: 10px;">F1</td></tr> <tr><td style="text-align: center;">DEF2 60.00</td><td style="padding-left: 10px;">F2</td></tr> <tr><td style="text-align: center;">MAX</td><td style="padding-left: 10px;">F3</td></tr> <tr><td style="text-align: center;">MIN</td><td style="padding-left: 10px;">F4</td></tr> </table>	DEF1 50.00	F1	DEF2 60.00	F2	MAX	F3	MIN	F4
DEF1 50.00	F1									
DEF2 60.00	F2									
MAX	F3									
MIN	F4									

 **Note**      Trying to set the frequency outside of the frequency limit will result in a frequency setting error being displayed on the screen.

The frequency can be set when the output is on.

### Setting the Peak Current Limit

---

Background      Setting the peak current limit sets a limit on the current that can be sourced by the power supply.

 **Note**      When the peak current limit is tripped, an alarm will sound. Press Shift + 9 to clear the Ipk alarm.

Shift+6 can also clear the Ipk alarm. See page 56 for details.

Steps      1. Press *Shift* + *I rms* to access the Ipeak menu.



- Set the peak current with the scroll wheel/keypad or with the F3 ~ F4 soft-keys. The MAX and MIN soft-keys set the peak current to the maximum and minimum, respectively.

---

Range      10% ~ 100% peak current value. The peak current value depends on the selected voltage range.

---

Soft-keys    MAX, MIN

---

- Press *Enter* to confirm the peak current setting.

**Example**

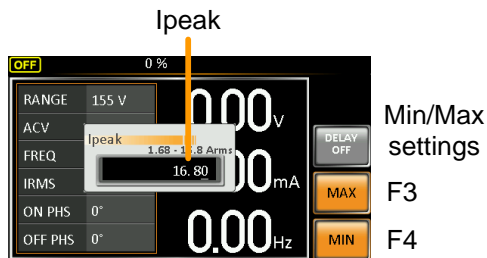

**Delay Time Settings**

The Delay Time setting essentially defines how long the measurement of the peak current must be sustained for before it is recognized. By default the delay time is turned off.

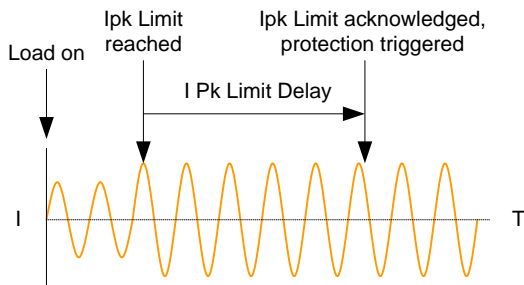

4. Press *Shift + I rms* and then press *DELAY[F2]*.
5. Set the desired delay time with the scroll wheel/keypad or with the F3 ~ F4 soft-keys. The MAX and MIN soft-keys set the delay time to the maximum and minimum, respectively.

Range 0(off) ~ 10 seconds

---

Soft-keys MAX, MIN

---

6. Press *Enter* to confirm the delay time setting.

Example

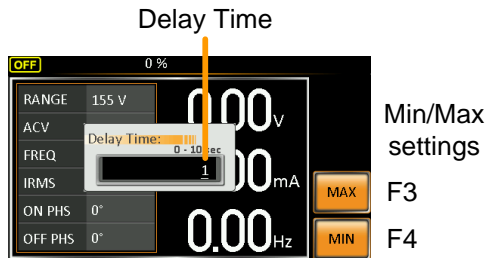

## Setting the Current RMS Level

**Background**                      The I rms setting sets the root mean square current.

- Steps**
1. Press *I rms* to access the I rms menu. Ipk-Limit  

  2. Set the I rms level with the scroll wheel/keypad or with the F3 ~ F4 soft-keys. The MAX and MIN soft-keys set the I rms level to the maximum and minimum, respectively.

**Range**                      0.00 ~ full scale A (dependant on the voltage range)

**Soft-keys**                  MAX, MIN

3. Press *Enter* to confirm the current setting.

### Example

**I rms**

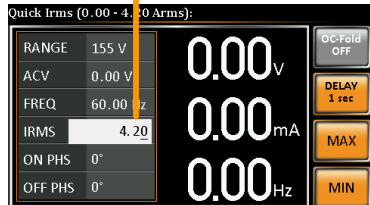

Min/Max settings  
F3  
F4

 **Note**

Setting the I rms level to 0.00 will disable OCP.

Setting the I rms to 0V is dangerous.

**I rms Delay Time Settings**

The Delay Time setting defines how long the I rms measurement must be sustained for before it is recognized. By default the I rms delay time is turned off.

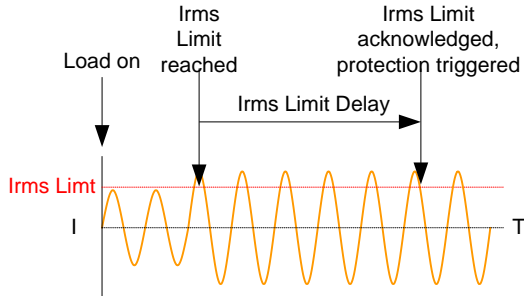

4. Press *I rms* and then press *DELAY[F2]*.
5. Set the desired delay time with the scroll wheel/keypad or with the F3 ~ F4 soft-keys. The MAX and MIN soft-keys set the delay time to the maximum and minimum, respectively.

---

Range      0(off) ~ 10 seconds

---

Soft-keys    MAX, MIN

---

6. Press *Enter* to confirm the delay time setting.

**Example**

**Delay Time**

OFF      0 %

RANGE	155 V	0.00	V
ACV	Delay Time: 0.00 s		
FREQ	0 ~ 10 Hz	0.00	mA
IRMS	1		
ON PHS	0°	MAX	
OFF PHS	0°	MIN	
		0.00	Hz

Min/Max settings

F3

F4

---

**OC Fold Settings** The over current fold back settings allow the APS-7000 to work as either a constant voltage source or a constant current source.

While the unit is sourcing less current than the  $I_{rms}$  current limit, the APS-7000 will act as a constant voltage source. In this mode, the voltage level will remain constant while the current level may vary. This is the normal operating mode.

When the current level reaches the  $I_{rms}$  limit, the APS-7000 will act as a constant current source. In this mode the current is constant and the voltage level varies. When the current subsides below the  $I_{rms}$  limit again, the unit will again act as a constant voltage source. When OC Fold is turned off, the APS-7000 will act as a current limiting power source when the  $I_{rms}$  limit has been reached.

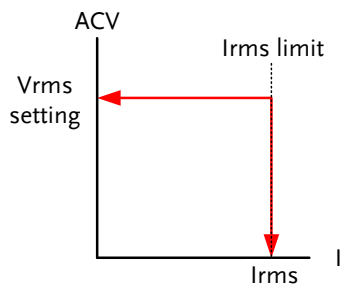

Note

OC-FOLD can only be active when the  $I_{rms}$  level is greater than 0.

7. Press  $I_{rms}$  and then press *OC-FOLD*[F1] toggle the OC-Fold function on or off.

## OC-Fold setting

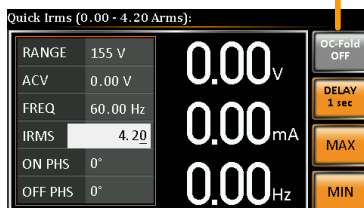

## Setting the On/Off Phase

---

### Background

The on phase setting sets the starting phase of the voltage output. The off phase setting sets the ending phase of the voltage output.

---

### Steps

1. Press *Shift* + 7 or *Shift* + 4 the On Phase or Off Phase, respectively.
 

Shift

+

7

or

4
2. Set the *On Phase* or *Off Phase* setting with the scroll wheel/keypad or with the F3 ~ F4 soft-keys. The MAX and MIN soft-keys set the phase to the maximum and minimum, respectively.

---

Range      0 ~ 359°

---

Soft-keys    MAX, MIN

---

3. Press *Enter* to confirm the phase setting.

Example

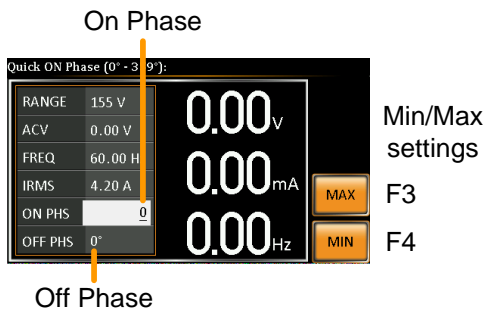

## Alarm Clear

**Background** The ALM CLR (Alarm Clear) function will clear any Over Power, Over Irms, Over Ipeak and Over Temperature alarms.

**Applicable Alarms** OVER POWER, OVER IRMS, OVER IPEAK, OVER TEMPERATURE

**Steps** 1. Press *Shift* + 6 to clear any alarms.

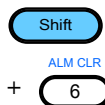

Example

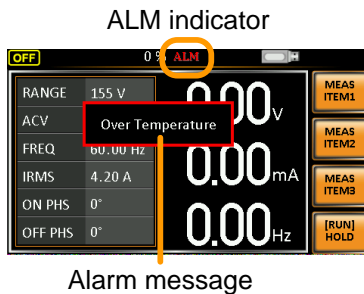



## Display Modes

The APS-7000 power supply has two display modes. The standard display mode shows the power supply setup on the left and the 3 configurable measurements on the right. The simple display mode shows all measurement items available on the APS-7000.

### Steps

1. Press the *Display* key.
2. The display mode will toggle each time the key is pressed.



### Standard Mode

Settings      Measurements

Configurable measurements

Hold measurement

### Simple Mode

Measurement Items

Hold measurement

### Configuring the Standard Mode Measurements

1. Press the *Meas Item1, Item2 or Item3* soft-key.



- Use the scroll wheel to select a measurement item and press Enter to confirm.

Sets first measurement item to Voltage

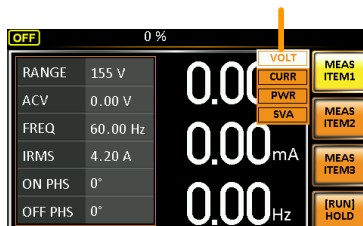

Hold  
Measurement

The Hold function will “hold” the current measurements on the display. Measurements won’t be updated on the display until the function is released.

Press *HOLD*[F4] to toggle hold on or off.

## Panel Lock

The panel lock feature prevents settings from being changed accidentally. When activated, all keys and knobs except the Lock/Unlock key and the Output key (if active) will be disabled.

If the instrument is remotely controlled via the USB/LAN/RS-232/GPIB interface, the panel lock is automatically enabled. See page 131 for remote control details.

Activate the panel lock

Press the *Lock* key to activate the panel lock. “Keys locked” appears on the display.



A lock icon will appear in the top corner when the panel keys are locked.



Disable the panel lock

Hold the *Lock* key for ~3 seconds to disable the panel lock. “Keys unlocked” will appear on the display and the padlock icon will disappear.



Example

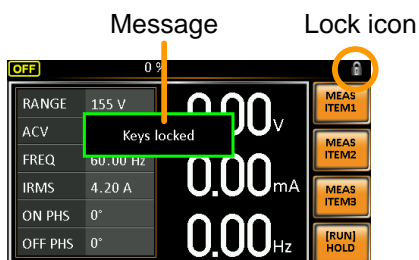

## Turning the Output On

When the output is turned on, the DUT can be connected to either the rear panel output or the front panel output.



Warning

Both of these outputs are electrically linked. Only one DUT should be connected to any one of the outputs at a time. Using both outputs at the same time is not supported. Using the front and rear outputs at the same time could cause dangerous operating conditions. See page 26 for details about using the output terminals or sockets.

Turn Output On

Press the *Output* key. The Output key will light up and ON will be displayed in the status bar to indicate that the output is on.



Turn Output Off

Press the *Output* key. The Output key light will go out and OFF will be displayed in the status bar to indicate that the output is off.

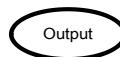

## Advanced Settings

- Surge/Dip Control → from page 61
- Ramp Control → from page 65

### Surge/Dip Control

Surge and dip control allows the power supply to source artificial surges or dips in voltage to a DUT. The surge/dip control feature provides a fast method to generate a surge/dip voltage event on a nominal voltage.

There have 4 parameters for configuring this feature: Mode selection (Mode), surge/dip voltage (ACV), the start time (T1) and testing duration(T2) of the surge/dip voltage period. The nominal voltage and frequency settings are based on the Basic Operation section.

---

Parameter Settings	Mode	
	Auto:	When the output is on, this mode will automatically generate a trigger at 0° to keep the surge or dip event repeatedly on site.
	Manual:	When the output is on, this mode will wait for the TRIG[F4] soft-key to be pressed before starting the surge or dip event on site.
	OFF:	Disables surge/dip control.

---



Note

The magnitude of the surge/dip part of the resultant waveform depends on the surge/dip ACV setting level.

Triggering Site selection: The surge/dip site is selected as shown below.  
 Example:

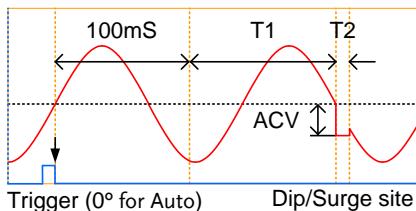

ACV Sets the ACV surge/dip level from the 0V level.

T1 Sets the T1 time.

T2 Sets the width of the surge/dip.

100mS Fixed 100mS delay after triggering.

**Steps**





1. Press the *Menu* key. The *Menu* setting will appear on the display. 
2. Use the scroll wheel to go to item 2, *Surge/Dip Control* and press *Enter*.
3. Go to the *Mode* setting using the scroll wheel and press *Enter*. Select the desired mode and press *Enter* again to confirm.

The Manual mode will allow you to manually trigger the surge/dip site. The Automatic setting will automatically trigger the surge/dip site.

Mode Manual, Auto, OFF

4. Set the remaining parameters.  
 Note: these parameters are not visible when *MODE* is set to *OFF*.

Remaining parameters ACV, T1, T2

Exit	<ol style="list-style-type: none"> <li>5. Press <i>Exit</i>[F4] to exit from the Surge/Dip Control settings.</li> <li>6. After exiting the menu, the surge/dip control icon will appear in the status bar.</li> </ol>	 
Triggering the Manual Surge/Dip Site	<p>For the manual mode, the surge/dip site is determined by a manual trigger.</p> <ol style="list-style-type: none"> <li>1. Configure the nominal voltage and frequency settings. See the Basic Operation chapter for details. <span style="float: right;">Page: 45, 47</span></li> <li>2. Turn the output on. The nominal settings above will be output. <span style="float: right;">Page 60</span></li> <li>3. Press <i>Shift</i> to arm the trigger.</li> </ol> <p>Press <i>TRIG</i>[F4] to generate the trigger manually via the front panel.</p> <p>Or, <span style="float: right;">OR</span> Alternatively, pulse the Trigger In pin on the J1 connector high to generate the trigger. <span style="float: right;">Page 127</span></p>	 



Note

The TRIG soft-key is only available when the surge/dip control is set to *Manual*.

Example

The following example shows a typical surge/dip output waveform.

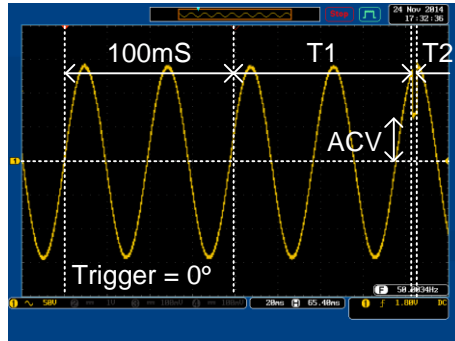



## Ramp Control

The Ramp Control function controls how fast the voltage level ramps up and down. This function allows you to ramp the voltage as a unit of time or as a unit of voltage.

Parameter Settings

Time The Time setting allows you to set the ramp time as ms/Vrms.

$$T_{up} = \text{ramp up time}/1V_{rms}$$

$$T_{dn} = \text{ramp down time}/1V_{rms}$$

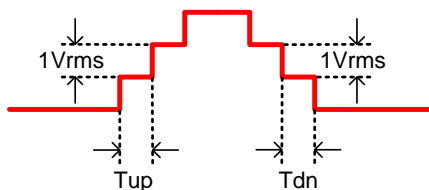

Voltage The Voltage setting allows you to set the ramp time as Vrms/ms.

$$V_{up} = \text{voltage up}/1ms$$

$$V_{dn} = \text{voltage down}/1ms$$

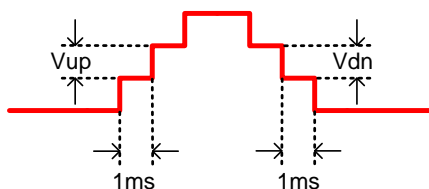

Steps

1. Press the *Menu* key. The Menu setting will appear on the display.
2. Use the scroll wheel to go to item 3, *Ramp Control* and press *Enter*.

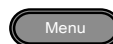

- Go to the *Mode* setting using the scroll wheel and press *Enter*. Select either *Voltage* or *Time* and press *Enter* again to confirm.

Mode	Voltage, Time
------	---------------

- For Voltage mode, set *Vup* and *Vdn*.

<i>Vup</i>	0.01 ~ 99.99Vrms
------------	------------------

<i>Vdn</i>	0.01 ~ 99.99Vrms
------------	------------------

- For Time mode, set *Tup* and *Tdn*.

<i>Tup</i>	0.1 ~ 999.9ms
------------	---------------

<i>Tdn</i>	0.1 ~ 999.9ms
------------	---------------

Exit

- Press *Exit*[F4] to exit from the Ramp Control settings.



- Upon exiting the ramp icon will appear in the status bar.



Example

Settings: Mode=Time,  $T_{up}=1$  msec,  $V_{AC}=100V$ ,  $Freq=50Hz$ , Ramp output=on.

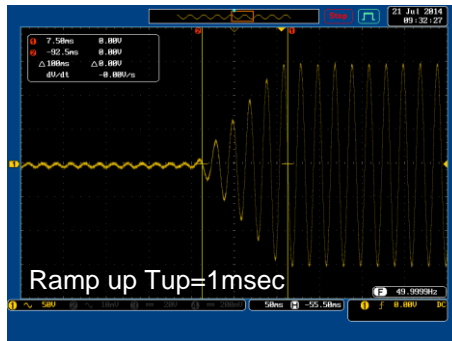

Example:

Settings: Mode=Voltage,  $V_{dn}=2V_{rms}$ ,  $V_{AC}=100V$ ,  $Freq=50Hz$ , Ramp output=off.

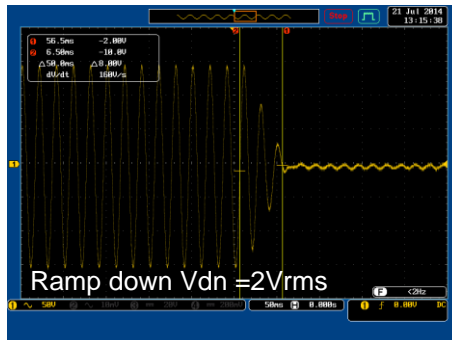

## Miscellaneous

The Miscellaneous menu contains miscellaneous parameter settings.

- T Ipeak, hold → from page 68
- Power ON Output → from page 70
- Buzzer → from page 71
- SCPI Emulation → from page 72
- Program Timer Unit → from page 73

### T Ipeak, hold

The T Ipeak, hold function sets the hold time for the peak current measurement. After the output is turned on, the APS-7000 will delay starting the peak current measurement by this hold time.

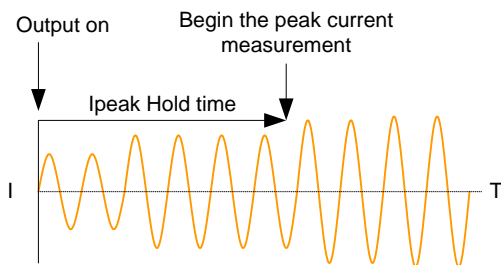

#### Steps

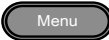
1. Press the *Menu* key. The Menu setting will appear on the display. 
2. Use the scroll wheel to go to item 4, *MISC Configuration* and press *Enter*.
3. Go to the *T Ipeak, hold(msec)* setting using the scroll wheel and press *Enter*. Set the time and press *Enter* again to confirm.

---

T Ipeak    1 ~ 60,000 ms

---

Exit

4. Press *Exit*[F4] to exit from the MISC Configuration settings.



Example



Settings

## Power ON Output

The Power ON Output setting allows you to have the output turn on automatically after startup. The settings that are loaded are the last settings that were present in the standard mode before the unit was turned off last.

### Steps

1. Press the *Menu* key. The Menu setting will appear on the display. 

2. Use the scroll wheel to go to item 4, *MISC Configuration* and press *Enter*.

3. Go to the *Power ON Output* setting using the scroll wheel and press *Enter*. Select a setting and press *Enter* to confirm.

---

ON	Set Output ON.
----	----------------

---

OFF	Set Output OFF.
-----	-----------------

---

SEQ	Execute the sequence that was loaded before the unit was last turned off.
-----	---

---

SIM	Execute the simulation that was loaded before the unit was last turned off.
-----	---

---

PROG	Execute the program that was loaded before the unit was last turned off.
------	--

---

### Exit

4. Press *Exit[F4]* to exit from the MISC Configuration settings. 

Example

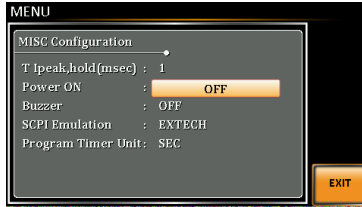

Settings

Buzzer

The Buzzer setting turns the buzzer sound on or off for key presses and alarms.

Steps

1. Press the *Menu* key. The Menu setting will appear on the display. 
2. Use the scroll wheel to go to item 4, *MISC Configuration* and press *Enter*.
3. Go to the *Buzzer* setting using the scroll wheel and press *Enter*. Turn the setting on or off and press *Enter* again to confirm.

Buzzer      ON, OFF

Exit

4. Press *Exit*[F4] to exit from the MISC Configuration settings. 

Example

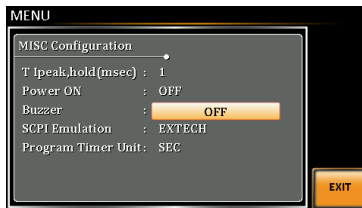

Settings

## SCPI Emulation

The SCPI Emulation setting supports both GW Instek as well as EXTECH SCPI remote commands. When set to EXTECH, the SCPI Emulation setting allows the APS-7000 to be a drop-in replacement for the EXTECH 6700 series by emulating the remote commands of the EXTECH units.

### Steps

1. Press the *Menu* key. The Menu setting will appear on the display. 
2. Use the scroll wheel to go to item 4, *MISC Configuration* and press *Enter*.
3. Go to the *SCPI Emulation* setting using the scroll wheel and press *Enter*. Choose the SCPI emulation mode and press *Enter* again to confirm.

SCPI Emulation    GW, EXTECH

### Exit

4. Press *Exit*[F4] to exit from the MISC Configuration settings. 

### Example



Settings



## Program Timer Unit

The Program Timer Unit setting is used to configure the timer unit for the Program mode.

---

### Steps

1. Press the *Menu* key. The Menu setting will appear on the display. 
  2. Use the scroll wheel to go to item 4, *MISC Configuration* and press *Enter*.
  3. Go to the *Program Timer Unit* setting using the scroll wheel and press *Enter*. Select the unit and press *Enter* to confirm.
- 

Program Timer Unit    Hour, Min, Sec

---

### Exit

4. Press *Exit[F4]* to exit from the MISC Configuration settings.



### Example



Settings

## Trigger

The trigger settings are used to turn the output on or off or to set the behavior of the Trigger In and Trigger Out pins of the J1 Connector. The trigger can also be used in conjunction with the Sequence mode, Simulation mode and Surge/Dip mode. See page 127 for further details.

### Pin Assignment

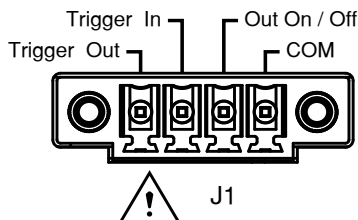

### Trigger Control Settings

The trigger control menu sets both the trigger in and the trigger out behavior of the J1 connector.





Note

The following trigger control settings are not applicable when in the Simulation test mode or the Sequence test mode.

### Steps

1. Press *Shift* + 2 to access the Trigger Control menu.
 

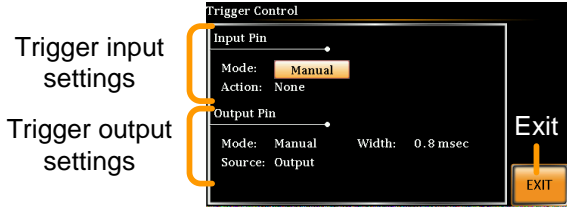

2. The trigger control settings appear. The settings are divided into Input Pin and Output Pin.



Trigger input settings

Trigger output settings

Trigger Input Pin 1. The Input Pin settings configure what action is taken when the Trigger In pin on the J1 connector is high.

2. Go to the *Mode* setting using the scroll wheel and press *Enter*. Choose Auto or Manual and then press *Enter* again to confirm.

---

Auto	Auto mode will trigger the system when the signal input into the Trigger In pin goes high (+5V).
------	--

---

Manual	The Manual mode will ignore any signal input into the Trigger In pin, but will trigger the system by remote commands <sup>[1]</sup> .
--------	---

---

3. Go to the *Action* setting using the scroll wheel and press *Enter*. Choose what will happen when the Trigger In pin is set high(+5V) and then press *Enter* to confirm.

---

None	No action is taken.
------	---------------------

---

Output	Turns the output on or off when triggered.
--------	--

---

Setting	Sets a user-defined voltage and frequency setting when triggered.
---------	---

---

Preset	Loads a preset setting when triggered.
--------	--

---

SurgeDip	Triggers the surge/dip control.
----------	---------------------------------

---

4. If Setting was chosen, Set Vset and Fset.

Vset	0 ~ full scale voltage (dependant on the chosen range; 600V optional)
------	---

Fset	45.00 ~ 500.0 Hz (999.9 Hz optional)
------	--------------------------------------

5. If Preset was chosen, choose which preset setting should be loaded when the Trigger Input is set to high(+5V).

Preset	0 ~ 9
--------	-------

Trigger Output Pin

1. Go to the *Mode* setting using the scroll wheel and press *Enter*. Choose Auto or Off and then press *Enter*.

Auto	Auto mode will set the Trigger Out pin to high (+5V) when the conditions are true.
------	--

Off	Off mode will set the Trigger Out pin to low (0V).
-----	--

2. Go to the *Source* setting to choose what function or test mode will be able to the trigger the output pin on.

None	No source is able to use the trigger output.
------	--

Output	The trigger output goes high (+5V) when the Output is turned on or off.
--------	---

Setting	When the settings change the trigger output goes high (+5V).
---------	--

Preset	When a preset is loaded or saved, the trigger output goes high (+5V).
--------	---

All	The trigger output goes high (+5V) when any of the settings, presets or output are changed.
-----	---

- Go to *Width* to set how long the trigger output is set high for.

---

Width      0.1 ~ 100.0ms

---

Exit

- Press *Exit*[F4] to exit from the Trigger Control settings.



[1] Remote  
Control  
Commands

The following remote control commands are applicable for the trigger input or output. See the programming manual for usage details.

---

\*TRG

```

:INITiate[:IMMEDIATE]:NAME
:INITiate[:IMMEDIATE][:TRANSient]
:MEMory:SAV
:MEMory:RCL
:MEMory:TRIGgered
:MEMory:TRIGgered?
:OUTPut[:STATe]:TRIGgered
:OUTPut[:STATe]:TRIGgered?
:SYSTem:CONFigure:TRIGger:INPut:MODE
:SYSTem:CONFigure:TRIGger:INPut:MODE?
:SYSTem:CONFigure:TRIGger:INPut:SOURce
:SYSTem:CONFigure:TRIGger:INPut:SOURce?
:SYSTem:CONFigure:TRIGger:OUTPut:MODE
:SYSTem:CONFigure:TRIGger:OUTPut:MODE?
:SYSTem:CONFigure:TRIGger:OUTPut:SOURce
:TRIGger:OUTPut:SOURce
:TRIGger:OUTPut:SOURce?
:TRIGger:OUTPut[:IMMEDIATE]
:TRIGger:MEMory:SOURce
:TRIGger:MEMory:SOURce?
:TRIGger:MEMory[:IMMEDIATE]
:TRIGger[:TRANSient]:SOURce
:TRIGger[:TRANSient]:SOURce?
:TRIGger[:TRANSient][:IMMEDIATE]
[:SOURce]:FREQuency:TRIGgered
[:SOURce]:FREQuency:TRIGgered?
[:SOURce]:VOLTage[:LEVel]:TRIGgered[:AMPLitude]
[:SOURce]:VOLTage[:LEVel]:TRIGgered[:AMPLitude]?

```

---

## Preset Settings



- Save Presets to Local Memory → from page 78
- Recall Presets to Local Memory → from page 79
- Manage Preset Settings → from page 80

### Save Preset Settings to Local Memory

Up to 10 preset settings can be saved to internal memory.

---

#### Steps

1. Press *Preset* and then hold a  number key (0~9) to save the present settings to the corresponding memory number.  +  (hold)

---

Presets	M0 ~ M9
---------	---------

---

2. Press the *Preset* key again to exit from the preset mode.
- 

#### Example

For example, pressing *Preset* & holding 1 will save the present settings to memory slot 1 (saved to M1).

---



#### Note

The preset key will become green when active. A beep will be heard (Buzzer set to ON) and a message will displayed when the settings are saved.

---

## Load Preset Settings to Local Memory

Any of the 10 preset settings can be recalled from internal memory.

---

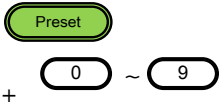
- Steps
1. Press *Preset* and press a *number key*(0~9) to load the corresponding memory number.  
  

---

Presets	M0 ~ M9
---------	---------

---
  2. Press the *Preset* key again to exit from the preset mode.

Example

For example, pressing *Preset* + 1 will recall the saved settings from memory slot 1 (recalled from M1).

---



Note

The preset key will become green when active. A beep will be heard and a message will be displayed when the settings are recalled.

---

## Manage Preset Settings

Preset settings can be easily saved to or from a USB flash drive using the Save/Recall Files utility in the Menu system. Files can also be deleted from local memory using the utility.

---

File Format	<p>When files are saved to USB they are saved in the following format:          presetX.set, where X is the memory number M0 ~ M9. The files are saved to USB:/gw.</p> <p>When files are recalled from USB, files must be recalled from the same memory number. For example, the file preset0.set can only be recalled to memory number M0. The files can only be recalled from the USB:/gw directory.</p>
-------------	--

---

Steps	<ol style="list-style-type: none"> <li>1. Press the <i>Menu</i> key. The Menu settings will appear on the display. </li> <li>2. Use the scroll wheel to go to item 12, <i>Save/Recall Files</i> and press <i>Enter</i>.</li> <li>3. Go to the <i>Type</i> setting using the scroll wheel and press <i>Enter</i>. Select <i>Preset</i> and press <i>Enter</i> to confirm.</li> <li>4. Go to the <i>Action</i> setting and choose the file operation and then press <i>Enter</i>.</li> </ol>						
	<table> <tr> <td style="border-bottom: 1px solid black;">MEM→USB</td> <td>Saves the selected preset memory from the local memory to a USB flash drive.</td> </tr> <tr> <td style="border-bottom: 1px solid black;">MEM←USB</td> <td>Loads a preset memory from a USB flash drive to the selected local memory.</td> </tr> <tr> <td style="border-bottom: 1px solid black;">DELETE(MEM)</td> <td>Deletes the selected preset memory from local memory.</td> </tr> </table>	MEM→USB	Saves the selected preset memory from the local memory to a USB flash drive.	MEM←USB	Loads a preset memory from a USB flash drive to the selected local memory.	DELETE(MEM)	Deletes the selected preset memory from local memory.
MEM→USB	Saves the selected preset memory from the local memory to a USB flash drive.						
MEM←USB	Loads a preset memory from a USB flash drive to the selected local memory.						
DELETE(MEM)	Deletes the selected preset memory from local memory.						



5. Go to the *Memory No.* setting and select the preset memory number to perform the operation on. Press *Enter* to confirm.

Memory No.    0 ~ 9 (M0 ~ M9)

Execute File  
Operation

6. Press *Exe[F1]* to perform the file operation.



Exit

7. Press *Exit[F4]* to exit from the *Save/Recall Files* settings.



Example



Settings

## Arbitrary Waveform Function

The ARB function is able to select a large range of continuous arbitrary waveforms. There are a number of basic waveform shapes to choose from, each of which can be customized to output a waveform with your desired attributes.

The ARB function can be used in conjunction with the Simulate and Sequences modes, but cannot be used with the Program test modes. When the WAVE parameter is set to any waveform other than SINE, ARB will be shown in the status bar when in the BASIC operation, Simulate mode or Sequence mode to indicate that the ARB function is active when in these modes.



Note

The output will always be turned off if the ARB waveform is changed. It is not possible to keep the output on whilst the type of ARB waveform is changed.

---

- ARB Function Overview → from page 83
- Selecting an ARB Waveform → from page 86

## ARB Mode Overview

### Background

The ARB mode function has 7 basic waveforms and a number of settable attributes, depending on the chosen waveform.

### Setting Screen Overview

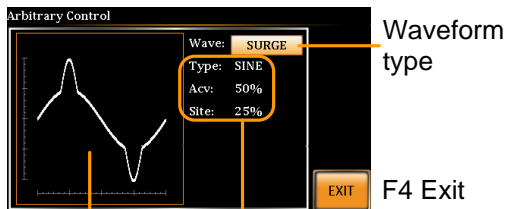

Visual representation of the waveform shape and its attributes

Attributes for the selected waveform

### ARB Waveform Overview

The following describes each of the 7 basic waveforms.

#### Sine

This is the default waveform used for the APS-7000. No settable attributes.

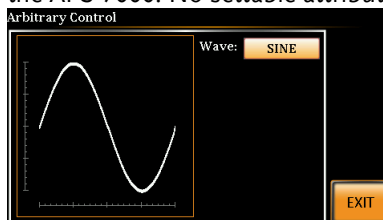

#### Triangle

Basic triangle waveform. No settable attributes.

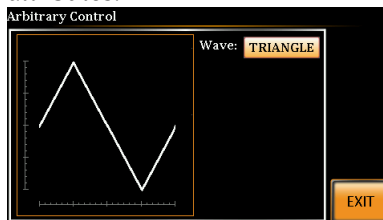

Staircase The staircase waveform has a settable number of step levels.

Attributes:

Stairs: 1 ~ 100

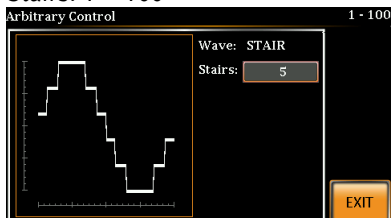

Clip Outputs a clipped sinewave. The degree to which the sine wave is clipped is settable.

Attributes:

$n * ACV$ : 1.0 ~ 10.0 (clip level)

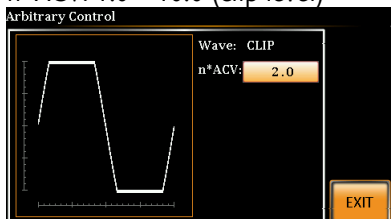

CF Crest factor waveform. The crest factor is settable.

Attributes:

CF: 1.4 ~ 10.0

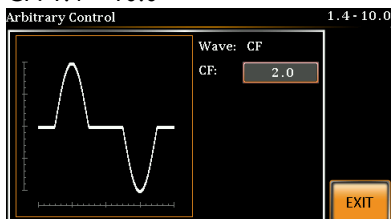

**Surge** The surge waveform has a settable ACV base level, site size and site shape.

Attributes:

Type: Sine, Square (site waveform type)

Acv: 0 ~ 100% (base waveform ampl.)

Site: 0 ~ 100% (site waveform width)

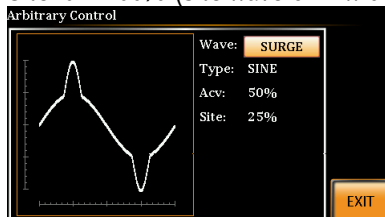

**ARB** The ARB waveform shape function simply adds a number Fourier series terms to create an arbitrary waveform.

Attributes:

Type: 1 ~ 22 (Number of selectable ARB waveforms)



The numerical figures shown under the Type parameter shows which Fourier series terms are used and their (bn) coefficients.

## Selecting an ARB Waveform

Entering the ARB Menu

1. Press *Shift* + *1* to access the ARB menu.

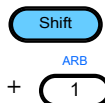

2. Set the *Wave* parameter with the scroll wheel and confirm the setting with the *Enter* key.

---

Wave	Sine, Triangle, Stair, Clip, CF, Surge, ARB
------	---

---

3. Use the scroll wheel and *Enter* key to select any other attributes for the selected waveform and press *Enter* to confirm any settings.

Other Attributes:

---

Sine Wave: None

---

Triangle Wave: None

---

Stair: Stairs: 1 ~ 100

---

Clip: N\*ACV: 1 ~ 10

---

CF: CF: 1.4 ~ 10.0

---

Surge: Type: Sine, Square  
ACV: 0 ~ 100%  
Site: 0 ~ 100%

---

Exit

4. Press *Exit*[F4] to exit from the ARB settings.



Common Settings 5. Press *Menu* to go back to the main menu. Menu

- 6. Set the voltage, frequency, Irms level and so on as you normally would for the standard ACV output. See the Basic Operation chapter for setting details. Page 43



Note

When the WAVE parameter is set to any waveform other than SINE, **ARB** will be shown on the display when in the BASIC operation, Simulate mode or Sequence mode to indicate that the ARB function is active when in these modes.

Standard Mode Example

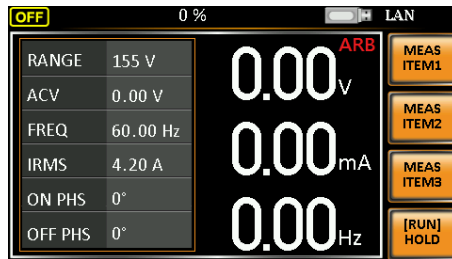

Simple Mode Example

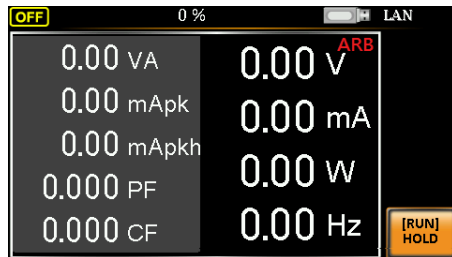

Sequence Example



Simulate Example

The screenshot shows the SIMULATE screen with the following elements:

- Top status bar: SIMULATE, ARB, LO (MD) (HI) (AUTO)
- Waveform display: A yellow sine wave with a purple envelope. The x-axis is labeled with 'Init', 'Normal1', 'Trans1', 'Abnormal', 'Trans2', 'Normal2', and 'Init'.
- Control table:

Step	Initial	Repeat	1
Time	0.10 s	ON Phs	ON 0
Vset	0.00	OFF Phs	ON 0
Fset	50.00	Trig Out	LO

- Right-side buttons: Mode (with a circular arrow icon), Recall None, Save None, and RUN.



## Test Mode Function

There are three test modes.

- Simulate Mode: voltage/frequency fluctuations.

The Simulate function is a quick and easy way to simulate fluctuations in voltage, frequency, phase and other anomalies in mains supply power.

- Sequence Mode: creates test sequences.

The Sequence function creates arbitrary AC waveforms based on user defined parameters.

- Program Mode: Runs a group of test sequences.

The Program function runs different memory steps sequentially. Each step of a program is a preset memory configuration (M01 ~ M50). The Program function can also perform pass/fail testing.

- Simulate Mode Overview → from page 91
- Simulate Settings → from page 95
- Save Simulation to Local Memory → from page 98
- Recall Simulation from Local Memory → from page 98
- Manage Simulation Settings → from page 99
- Run Simulation → from page 101
  
- Sequence Mode Overview → from page 103
- Sequence Settings → from page 107
- Save Sequence to Local Memory → from page 111
- Recall Sequence from Local Memory → from page 111
- Manage Sequence Settings → from page 112
- Run Sequence → from page 114

- Program Mode Overview → from page 116
- Save a Program to Local Memory → from page 123
- Recall a Program from Local Memory → from page 123
- Manage Program Settings → from page 124

## Simulate Mode Overview

### Background

The Simulate function is used to test power supply fluctuation. This function is able to simulate common abnormalities in mains power such as fluctuations in voltage, phase and frequency. These simulations can be run as one-off anomalies or cyclic anomalies.

### Setting Screen Overview

Number of repetitions

V RANGE

Mode Test mode

Recall None Recall test

Save None Save test

RUN Run test

ON Phs ON 0 ON/OFF phase

OFF Phs ON 0

Trig Out LO Trigger output level

Step Initial Repeat 1

Time 0.10 s

Vset 0.00

Fset 50.00

Step Frequency

Step voltage

Step time

Step

### Step Overview

The Simulate function is comprised of 6 steps. Each step is run sequentially in the following order: Initial, Normal1, Trans1, Abnormal, Trans2, Normal2, Initial.

**Initial** The Initial step is used as the initial and final settings of the waveform simulation. This is the standby step before the test starts and the standby step after the test ends.

**Normal1** This step configures the normal output conditions that precede the abnormal conditions.

Trans1	This step configures the transition from normal to abnormal conditions. This step will linearly interpolate the normal settings to the abnormal settings. This step can be skipped for abrupt state changes.
Abnormal	This step contains the abnormal conditions for the simulation.
Trans2	This step configures the transition from abnormal to normal conditions.
Normal2	This step configures the normal conditions that supersede the abnormal conditions.

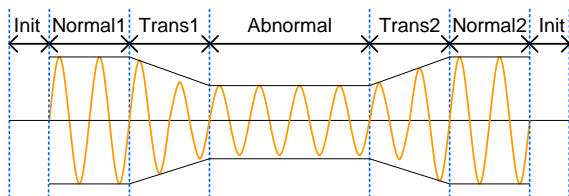

**Parameter Overview**

The following table shows which parameters are available for each step.

Step\Parameter	Initial	Normal1	Trans1	Abnormal	Trans2	Normal2
Repeat	✓	✓	✓	✓	✓	✓
Time	✓	✓	✓	✓	✓	✓
ON Phs	✓	✓	X	✓	X	✓
OFF Phs	✓	✓	X	✓	X	✓
Vset	✓	✓	X	✓	X	✓
Fset	✓	✓	X	✓	X	✓
Trig Out	✓	✓	✓	✓	✓	✓

---

Repeat	Indicates the number of times the simulation will be run, from Normal1 to Normal2.  A value of 0 indicates infinite repeats. The repeat setting is the same for each step.
Time	Sets the duration time of the step. When the ON Phs=ON, the total duration of the step is equal to the Time setting + ON Phs=ON duration.
ON Phs	Sets the starting phase of the waveform for the step. Not applicable for the Trans 1/2 steps.
OFF Phs	Sets the off phase of the waveform after the output has been turned off. Not applicable for the Trans 1/2 steps.
Fset	Sets the frequency of the step. Not applicable for the Trans 1/2 steps.
Vset	Sets the voltage of the step. Not applicable for the Trans 1/2 steps.
Trig Out	Sets the polarity of the trigger out port for the duration of the step. The trigger out signal is sent at the start of each step (including the first initial step).

---

The following diagram illustrates the relationship between each of the parameters in a step.

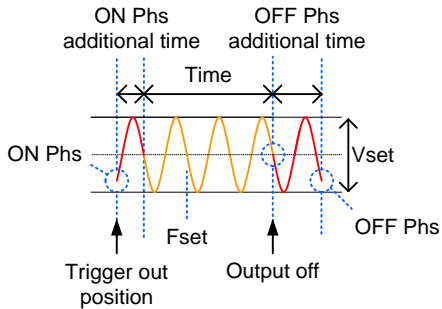

## Simulate Settings

Entering the Simulate Menu

1. Press *Test*.

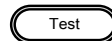

2. Press *Mode[F1]* and use the scroll wheel to select *SIMULATE* and then press *Enter*.

### Simulate Mode

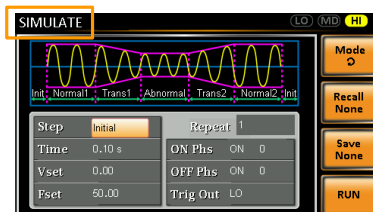

F1 Mode

Steps

3. Use the scroll wheel to go to the *Step* setting and press *Enter*.
4. Use the scroll wheel to select one of the simulation steps and press *Enter*.

Steps	Initial, Normal1, Trans1, Abnormal, Trans2, Normal2
-------	---

5. Go to the *Time* setting and set the duration of the step.

Time	0.01 ~ 99.99s, 0(Trans 1 and Trans2) Note: For Trans1 and Trans2, it supports a value of 0, which will skip the step.
------	--

- Go to the *ON Phs* setting and set the starting phase of the step. Not applicable for Trans1 or Trans2.

ON Phase	ON, OFF
----------	---------

ON Phase	0~ 359°
----------	---------

Resolution	1°
------------	----

- Go to the *OFF Phs* setting and set the end phase of the step. Not applicable for Trans1 or Trans2.

OFF Phase	ON, OFF
-----------	---------

OFF Phase	0~ 359°
-----------	---------

Resolution	1°
------------	----

- Press the *Range* key repeatedly to set the voltage range for the *Vset* parameter. The range will be shown in the top corner, which indicates that the simulation will be executed within this voltage range.

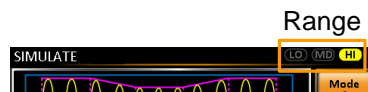

Range	LO(155V), MD(310V), HI(600V, optional)
-------	--

- Go to the *Vset* setting and set the *Vrms* level of the step. If you input a *Vset* value that is not within the voltage range, the input value will be ignored.

Not applicable for Trans1 and Trans2.

Vset	0.00 ~ 310.0Vrms (range dependent) (600V optional)
------	---



10. Go to the *Fset* setting set the frequency of the step. Not applicable for Trans1 and Trans2.

---

Fset            45.00 ~ 500.0Hz (999.9Hz optional)

---

11. Go to the *Trig Out* setting and set the state of the trigger out pin at the start of each step.

---

Trig Out    HI, LO

---

12. Lastly, go to the *Repeat* parameter select the number of times the simulation will repeat the Normal1-Trans1-Abnormal-Trans2-Normal2 sequence of steps. A value of 0 will set the number of repetitions to infinite.

---

Repeat        1 ~ 9999, 0(infinite)

---

## Save a Simulation to Local Memory

---

Saving a Simulation	Simulation settings can be saved to one of 10 memory slots (SIM0 ~ SIM9).
Steps	<ol style="list-style-type: none"><li>1. Press <i>Save</i>[F3] and then long press a <i>number key</i> when prompted.</li><li>2. A message will appear when the save is successful.</li></ol>
Save	SIM0 ~ SIM9

---

## Recall a Simulation from Local Memory

---

Recall a Simulation	Simulation settings can be recalled from one of 10 memory slots (SIM0 ~ SIM9).
Steps	<ol style="list-style-type: none"><li>1. Press <i>Recall</i>[F2] and then press a <i>number key</i> when prompted.</li><li>2. A message will appear when the settings are recalled successfully.</li></ol>
Recall	SIM0 ~ SIM9

---

## Manage Simulation Settings

Simulation settings can be easily saved to or from a USB flash drive using the Save/Recall Files utility in the Menu system. Files can also be deleted from local memory using the utility.

---

File Format	<p>When files are saved to USB they are saved in the following format: simX.sim, where X is the memory number 0 ~ 9 (SIM0 ~ SIM9). The files are saved to USB:/gw.</p> <p>When files are recalled from USB, files must be recalled from the same memory number. For example, the file sim0.sim can only be recalled to memory number SIM0. The files can only be recalled from the USB:/gw directory.</p>
-------------	---

---

- |       |   |
|-------|---|
| Steps | <ol style="list-style-type: none"> <li>1. Press the <i>Menu</i> key. The Menu settings will appear on the display. </li> <li>2. Use the scroll wheel to go to item 12, <i>Save/Recall Files</i> and press <i>Enter</i>.</li> <li>3. Go to the <i>Type</i> setting using the scroll wheel and press <i>Enter</i>. Select <i>SIMULATE</i> and press <i>Enter</i> to confirm.</li> <li>4. Go to the <i>Action</i> setting and choose the file operation and then press <i>Enter</i>.</li> </ol> |
|-------|---|
- 

MEM→USB	Saves the selected simulation memory from the local memory to a USB flash drive.
---------	--

---

MEM←USB	Loads the simulation memory from a USB flash drive to the selected local memory.
---------	--

---

DELETE(MEM) Deletes the selected simulation memory from local memory.

- Go to the *Memory No.* setting and select the simulation memory number to perform the operation on. Press *Enter* to confirm.

Memory No. 0 ~ 9 (SIM0 ~ SIM9)

Execute File Operation

- Press *Exe[F1]* to perform the file operation.



Exit

- Press *Exit[F4]* to exit from the *Save/Recall Files* settings.



Example



Settings

## Running a Simulation

**Background** When running a simulation, the display changes to the simulate run view.

**Run Screen Overview**

**Settings**

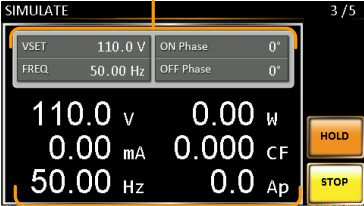

The screenshot shows a 'SIMULATE' screen with a top status bar '3/5'. Below it is a settings table:

VSET	110.0 V	ON Phase	0°
FREQ.	50.00 Hz	OFF Phase	0°

Below the settings table are readback measurements:

110.0 V      0.00 W  
 0.00 mA    0.000 CF  
 50.00 Hz    0.0 Ap

On the right side of the screen are two buttons: 'HOLD' (orange) and 'STOP' (yellow).

Step X of Y

Hold/Conti test

Stop/Run test

Readback measurements

**Steps**

1. Press *Output*.



2. Press *Run[F4]*. The test will start to run.

The settings of the current step will be shown at the top of the screen and the measurement readout will be shown on the bottom of the screen.

The top-right of the screen will display the current step number of the simulation.

- |                |              |
|----------------|--------------|
| 1/5 = Normal1  | 2/5 = Trans1 |
| 3/5 = Abnormal | 4/5 = Trans2 |
| 5/5 = Normal2  |              |

3. The test will continue to run until the last repeat step has run, *Stop[F4]* is pressed or the output is turned off\*. When the test has finished/stopped, the screen will return to the original settings screen.

\* If the OFF-phase has been set, the output will continue until the OFF-phase setting is satisfied.

---

Hold Test	To pause the test mid-way, press <i>Hold[F3]</i> .
-----------	--

---

Continue Test	To continue a paused test, press <i>Conti[F3]</i> .
---------------	---

## Sequence Mode Overview

### Background

The Sequence function creates wholly AC arbitrary waveforms. These waveforms are made from a number of steps that when run creates an arbitrary waveform.

A Sequence function can be comprised of up to 255 steps.

### Setting Screen Overview

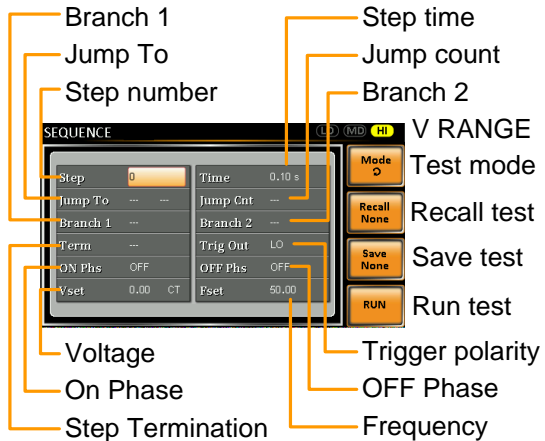

### Sequence Parameter Overview

The Sequence function is comprised of a minimum of 2 steps that are executed in user defined sequences.

Each step can have different step times, voltage levels, start phases, stop phases and frequencies.

Note: Step 0 is assigned as a “Standby” step. At the end of the test the unit will shift to the standby step.

---

Step	Assigns the step number.
Time	Sets the step duration time. This step time is exclusive of any transition time needed to match start phases. See the diagram on page 106 for details.
Jump To	The Jump To setting determines which step to jump to at the end of the step. If Jump To is turned off, the unit will follow the Term (Step termination) setting for the step.
Jump Cnt.	Determines the number of times to loop the jump step.
Branch1/ Branch2	The Branch settings allow you to make a selectable branch within the sequence when the sequence is running or on hold. The branch1 or branch2 actions are enabled by pressing the F1 or F2 function keys, or by using the :TRIG:SEQ:SEL:EXEC remote control command. After the branch step(s) have completed the unit will return back to the step from which the branch was executed and continue to run the step from where it left off.

---



---

Term	<p>Determines the step termination settings at end of the step.</p> <p>The CONT setting tells the sequence to go to the next step.</p> <p>The HOLD setting will pause the output at the end of the step and will only continue to the next step when CONT[F3] is pressed.</p> <p>The END setting will end the sequence and go to Step 0(standby step).</p>
Trig Out	<p>Sets the polarity for the trig out pin on the J1 connector when the step is running.</p>
ON/OFF Phs	<p>Sets the start and stop phase of the AC waveform. The ON Phs setting sets the starting phase <i>of the step</i>.</p> <p>OFF Phs sets the off phase <i>for the output</i> when the output if turned off.</p>
Vset	<p>Sets the AC voltage level. There are 3 secondary voltage settings that determine how the voltage is output.</p> <p>Constant: Sets the voltage level of the step immediately to Vset values.</p> <p>Keep: Sets the voltage level to “keep” the voltage of the previous step.</p> <p>Sweep: Linearly increases or decreases the values from the end of the previous step to the end of the current step.</p>
Voltage Range	<p>There are 3 voltage range settings: HI range (0~600VAC), MD range (0~310VAC), LO range (0~ 155VAC)</p>

---

Fset Sets the frequency of the step.

Sequence Example

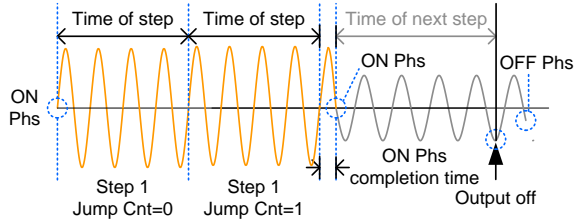

Sequence Flow Example

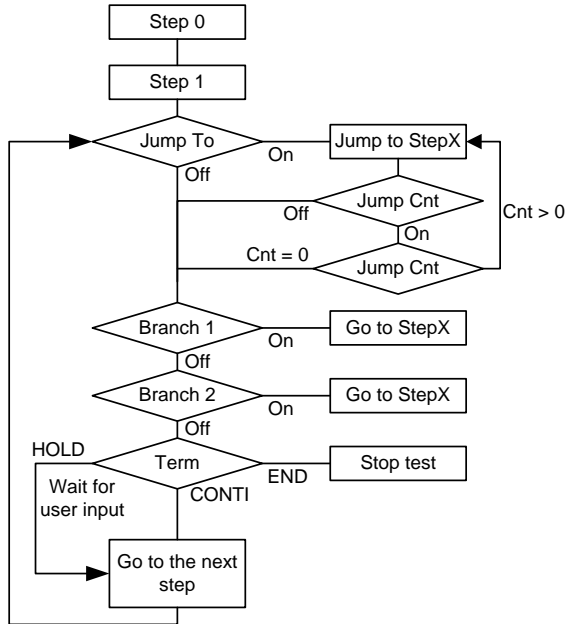

## Sequence Settings

Entering the  
Sequence Menu

1. Press *Test*.

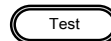

2. Press *Mode[F1]* and use the scroll wheel to display *Sequence Mode* and then press *Enter*.

Sequence Mode Voltage range



Steps

3. Use the scroll wheel to go to the *Step* setting and press *Enter*.
4. Use the scroll wheel to select the step number. 0 is always the starting step for the sequence.

---

Step 0 ~ 255

5. Go to the *Time setting* and set the duration of the step.

---

Time 0.01 ~ 99.99s

6. Go to the *Jump To* setting and choose which step to jump to, or turn the setting off.

---

Step ON, OFF, 0 ~ 255

7. Go to the *Jump Cnt* setting and set the number of times the current step will loop.

---

Jump Cnt      1 ~ 255, 0

Note: A setting of 0 will set the number of jumps to infinite.

---

8. Go to the *Branch 1/2* setting and set a step to branch to.

---

Branch 1, 2    ON, OFF, 0 ~ 255

---

9. Go to the *Term* setting and set the step termination setting. CONTI will automatically go to the next step at the end of the step. END will return to step 0. HOLD will stay at the current step until you allow the sequence to continue to the next step.

---

Term            CONTI, END, HOLD

---

10. Go to the *Trig Out* setting and set the output state of the trigger out pin when the step has started.

---

Trig Out        HI, LO

---

11. Go to the *ON Phs* setting and set the starting phase of the step.

---

ON Phase        ON, OFF

---

ON Phase        0~ 359°

---

Resolution      1°

---

12. Go to the *OFF Phs* setting and set the end phase of the step.

---

OFF Phase        ON, OFF

---

OFF Phase        0~ 359°

---

Resolution      1°

---

13. Press the *Range* key repeatedly to set the voltage range for the *Vset* parameter. The Range will be shown in the top corner.



---

Range	LO(155V), MD(310V), HI(600V, optional)
-------	--

---

14. Go to the *Vset* setting and set the output voltage for the step. If you input a *Vset* value that is not within the voltage range, the input value will be ignored.

Next set the secondary voltage settings to determine characteristics of the voltage output.

---

<i>Vset</i>	0 ~ 310V (range dependent) (600V optional)
-------------	---

---

Secondary settings	CT (Constant), KP (Keep), SP (Sweep)
--------------------	--------------------------------------

Note: Step 0 can only be set to CT or SP.

---

15. Go to the *Fset* setting and set the frequency of the step.

---

<i>Fset</i>	45.00 ~ 500.0Hz(999.9Hz optional)
-------------	-----------------------------------

---

Example Test

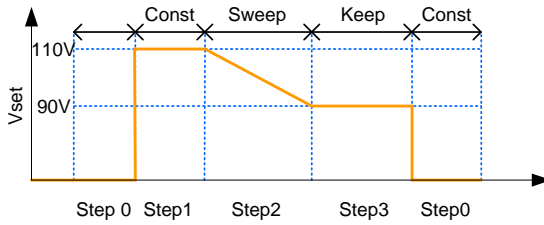

The example above shows how the secondary voltage settings affect how the voltage is output in each step.

Step no.	0	1	2	3
Vset (V)	0	110	90	N/A
2 <sup>nd</sup> Setting	CT	CT	SP	KP

## Save a Sequence to Local Memory

---

**Saving a Sequence**                      Sequence settings can be saved to one of 10 memory slots (SEQ0 ~ SEQ9).

- Steps**
1. Press *Save*[F3] and then long press a *number key* when prompted.
  2. A message will appear when the save is successful.
- 

Save                      SEQ0 ~ SEQ9

## Recall a Sequence from Local Memory

---

**Recall a Sequence**                      Sequence settings can be recalled from one of 10 memory slots (SEQ0 ~ SEQ9).

- Steps**
1. Press *Recall*[F2] and then press a *number key* when prompted.
  2. A message will appear when the settings are recalled successfully.
- 

Recall                      SEQ0 ~ SEQ9

## Manage Sequence Settings

Sequence settings can be easily saved to or from a USB flash drive using the Save/Recall Files utility in the Menu system. Files can also be deleted from local memory using the utility.

---

**File Format**                      When files are saved to USB they are saved in the following format:  
seqX.seq, where X is the memory number 0 ~ 9 (SEQ0 ~ SEQ9). The files are saved to USB:/gw.

When files are recalled from USB, files must be recalled from the same memory number. For example, the file seq0.seq can only be recalled to memory number SEQ0. The files can only be recalled from the USB:/gw directory.

---

### Steps

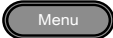
1. Press the *Menu* key. The Menu settings will appear on the display. 
2. Use the scroll wheel to go to item 12, *Save/Recall Files* and press *Enter*.
3. Go to the *Type* setting using the scroll wheel and press *Enter*. Select *SEQUENCE* and press *Enter* to confirm.
4. Go to the *Action* setting and choose the file operation and then press *Enter*.

---

**MEM→USB**      Saves the selected sequence memory from the local memory to a USB flash drive.

---

**MEM←USB**      Loads the sequence memory from a USB flash drive to the selected local memory.

---



---

DELETE(MEM) Deletes the selected sequence memory from local memory.

---

5. Go to the *Memory No.* setting and select the sequence memory number to perform the operation on. Press *Enter* to confirm.
- 

Memory No. 0 ~ 9 (SEQ0 ~ SEQ9)

---

Execute File  
Operation

6. Press *Exe[F1]* to perform the file operation.



Exit

7. Press *Exit[F4]* to exit from the *Save/Recall Files* settings.



Example

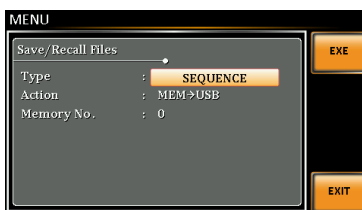

Settings

## Running a Sequence

**Background** When running a sequence, the display changes to the sequence run view.

**Run Screen Overview**

Settings

SEQUENCE 1 / 255

VSET	110.0 V	ON Phase	0°
FREQ	50.00 Hz	OFF Phase	0°

110.0 V    0.00 W  
0.00 mA    0.000 CF  
50.00 Hz    0.0 Ap

BRN1  
BRN2  
HOLD  
STOP

Step X of Y  
Branch 1  
Branch 2  
Hold/Conti test  
Stop/Run test

Readback measurements

**Steps**

1. Press *Output*.



2. Press *Run[F2]*. The test will start to run.

The settings of the current step will be shown at the top of the screen and the measurement readout will be shown on the bottom of the screen.

The top-right of the screen will be display the current step number by the total number of steps (current step/total steps).

3. The test will continue to run until the last step has run, or *Stop[F4]* is pressed. When the test has finished/stopped, the screen will return to the original settings screen.
4. If any of the steps have a conditional branch configured, the branch can be manually evoked

---

during run time by pressing the *BRN1[F1]* (branch 1) soft-key or the *BRN2[F2]* soft-key(branch 2). Alternatively the `:TRIG:SEQ:SEL:EXEC` command can also be used evoke a conditional branch.

---

Hold Test            5. To pause the test mid-way, press *Hold[F3]*.

---

Continue Test        6. To continued a paused test, press *Conti[F3]*.

## Program Mode Overview

---

### Background

The Program mode creates a test program comprised of a number of different memories and steps that can include pass/fail testing. Each memory is made up of 9 steps and each program is made up of 50 memories. A program will run each memory sequentially, which in turn will run each step in the memory sequentially until the program is terminated or a step in the program is programmed to end. Each memory, each step and even each program can also be programmed to loop a user-defined number of times. The diagram below shows the basis of a program.

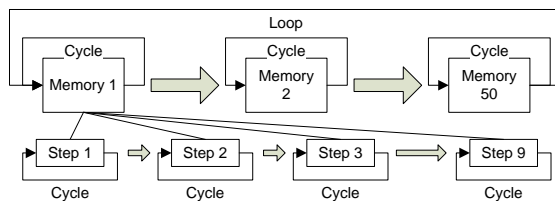

Setting Screen  
Overview

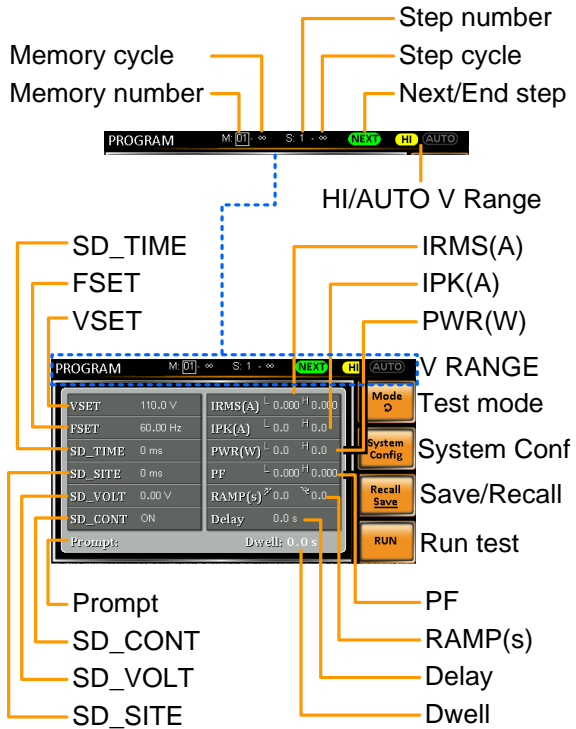

Settings Screen  
Parameter  
Overview

The following list describes the parameters on the settings screen.

---

Memory number      Sets the current memory number.

---

Memory cycle      Sets the number of cycles for the selected memory number.

---

Step number      Sets the current step for the current memory number.

---

Step cycle      Sets the number of cycles for the selected step number.

---

**NEXT/END** This setting will configure the action after a step has completed. NEXT will go to the next step/memory. END will end the program at the end of the step.

**HI/AUTO V range** Sets the voltage range for the program, HI or AUTO.  
 When set to AUTO, the unit will automatically set the range to 155VAC, 310VAC or 600VAC (the APS-003 option only).  
 When set to HI, the unit range is set to 310VAC or 600VAC if the APS-003 option is installed.

**VSET** Sets the output voltage for the current step.

**FSET** Sets the frequency for the current step.

**SD\_SITE** Surge/Dip site position. (T1 time)

**SD\_TIME** Surge/Dip time. (T2 time)

**SD\_VOLT** Surge/Dip voltage. (ACV)

**SD\_CONT** Surge/Dip trigger control. Manual or Auto.

Example

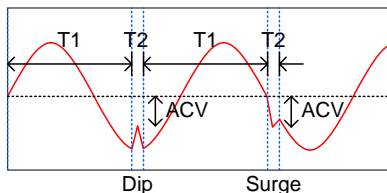

**IRMS(A)** Sets the IRMS high/low limit for the step.

**IPK(A)** Sets the peak current high/low limit for the step.

PWR(W)	Sets the power high/low limit for the step.
PF	Sets the power factor high/low limit.
Ramp Up/Down	Sets the ramp up and down times.
Delay	The delay time introduces a delay time before testing pass/fail limits. The delay timing starts as soon as a step has started.
Dwell	The dwell time sets the total execution time of the step.
Prompt	Sets a user-defined text message for the current step.  Note: The Enter soft-key must be used to exit out of the text input screen.

On screen keyboard



Enter soft-key

System Configuration Screen Overview

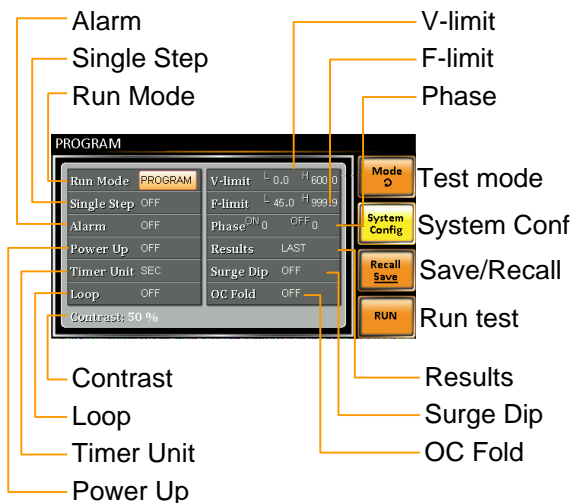

System Configuration Parameters

The System Configuration screen is accessible when the *System Config*[F2] soft-key is pressed.

**Run Mode** When set to “MANUAL” mode, only Memory number, VSET, FSET, H-IRMS(A), SD-VOLT, SD-SITE, SD\_CONT and SD-TIME will be enabled.  
When set to “PROGRAM” mode, all the parameters are available.

**Single Step** Sets the program to run only one step at a time. After a step is run the program is held until the Output key is pressed, after which the program will go to the next step.

**Alarm** Turns the alarm buzzer on/off.

**Power Up** When this option is turned on, the current program will be loaded and run after APS-7000 powers up.



Timer Unit	Sets the time units for the Dwell and Delay parameters.
Loop	Determines how many times the program itself will loop (M1 through M50).
V-Limit	Sets the voltage limit.
F-Limit	Sets the frequency limit.
Phase	Sets the ON phase and OFF phase of the step.
Results	Configures how the results are displayed:

ALL: Shows all the step results on the screen.

Example:

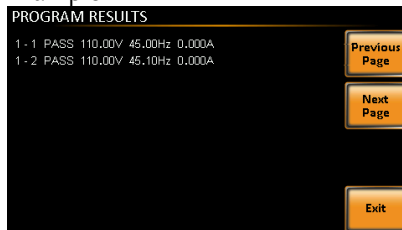

LAST: Only displays the last result.



P/F: If one of the test results is judged a fail, then FAIL is displayed on the screen.

Fail Example:



Pass Example:

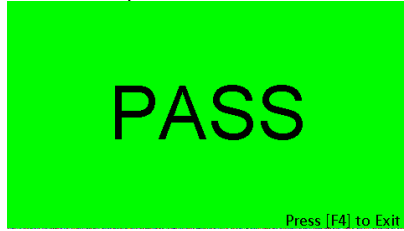

---

Surge/Dip	Turns the Surge Dip function on/off.
OC Fold	Turns OC Fold on/off.
Contrast	Sets the LCD contrast.

---

## Save a Program to Local Memory

---

**Saving a Sequence**      Sequence settings can be saved to one of 10 memory slots (PROG0 ~ PROG9).

- Steps**
1. Press *Save/Recall*[F3] and then long press a *number key*.
  2. A message will appear when the save is successful.
- 

Save                      PROG0 ~ PROG9

## Recall a Program from Local Memory

---

**Recall a Sequence**      Sequence settings can be recalled from one of 10 memory slots (PROG0 ~ PROG9).

- Steps**
1. Press *Recall*[F2] and then press a *number key*.
  2. A message will appear when the settings are recalled successfully.
- 

Recall                     PROG0 ~ PROG9

## Manage Program Settings

Program settings can be easily saved to or from a USB flash drive using the Save/Recall Files utility in the Menu system. Files can also be deleted from local memory using the utility.

---

**File Format**                      When files are saved to USB they are saved in the following format:  
progX.pro, where X is the memory number 0 ~ 9 (PROG0 ~ PROG9). The files are saved to USB:/gw.

When files are recalled from USB, files must be recalled from the same memory number. For example, the file prog0.pro can only be recalled to memory number PROG0. The files can only be recalled from the USB:/gw directory.

---

### Steps

1. Press the *Menu* key. The Menu settings will appear on the display. 
2. Use the scroll wheel to go to item 12, *Save/Recall Files* and press *Enter*.
3. Go to the *Type* setting using the scroll wheel and press *Enter*. Select *SEQUENCE* and press *Enter* to confirm.
4. Go to the *Action* setting and choose the file operation and then press *Enter*.

---

**MEM→USB**                      Saves the selected program memory from the local memory to a USB flash drive.

---

**MEM←USB**                      Loads the program memory from a USB flash drive to the selected local memory.

---

DELETE(MEM) Deletes the selected program memory from local memory.

5. Go to the *Memory No.* setting and select the program memory number to perform the operation on. Press *Enter* to confirm.

Memory No. 0 ~ 9 (PROG0 ~ PROG9)

Execute File Operation

6. Press *Exe[F1]* to perform the file operation.



Exit

7. Press *Exit[F4]* to exit from the *Save/Recall Files* settings.



Example



Settings

# REAR PANEL SIGNAL

## OUTPUTS

The rear panel has 3 signal output connectors. These connectors are used for external triggering, synchronization and test judgment state. The following chapter will give a brief overview each of these connectors.

---

J1 Connector Overview .....	127
Signal Output Overview .....	129
SYNC Output Overview .....	130

## J1 Connector Overview

**Overview** The J1 connector is primarily used for triggering and for monitoring the status of the power supply. Each pin is isolated from the power supply (photo coupled). The Trigger In and Out On/Off input can accept up to 30V/8mA. The Trigger Out port is pulled high internally to +5V.

The trigger control menu configures the Trigger In and Trigger Out pins. See page 74 for details on the trigger control settings.

### Pin Assignment

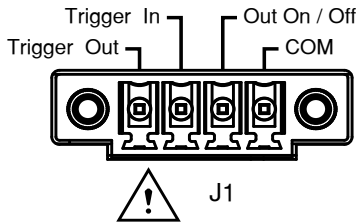

Pin name	Pin	Description
	Trigger Out	Outputs a high signal (+5V) according to the Trigger Out settings in the Trigger Control menu.
	Trigger In	Applying a high level signal to the Trigger In pin performs an action according to the settings in the Trigger Control menu. Actions include, turning the output on, loading a setting or loading one of the preset settings.
	Out On/Off	Applying a high level signal to this port will turn the output on by default.
	COM	Common pin.

Wiring Schematic

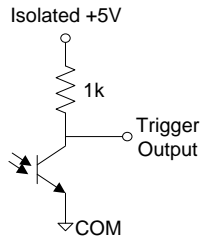

Trigger Input, OUT On/Off

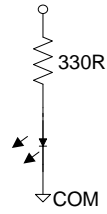





## Signal Output Overview

**Overview**                      The Signal Output port is used in the Program Mode. This port is used to remotely monitor the PASS, FAIL and Processing conditions. Each of these conditions are isolated from the APS-7000 with internal relays.

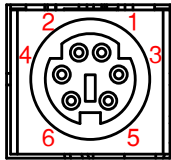
**Pin Assignment**              Remote relay contact



Pin name	Pin number	Description
	1	Pass pin
	2	Pass return pin
	3	Processing pin
	4	Fail pin
	5	Processing return pin
	6	Fail return pin
	Pass: Connect between Pin1 and Pin2	
	Fail: Connect between Pin4 and Pin6	
	Processing: Connect between Pin3 and Pin5	

 **CAUTION**      The internal relays allow for a maximum voltage of 250VAC and maximum current of 3A.

## SYNC Output Overview

---

Overview                      The SYNC output outputs a +10V signal when the output is turned on.

---

Pin Assignment

SYNC

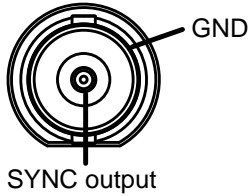

# C

# COMMUNICATION

# INTERFACE

This chapter describes basic configuration of IEEE488.2 based remote control. For a command list, refer to the programming manual, downloadable from GW Instek website, [www.gwinstek.com](http://www.gwinstek.com)



Note

If the instrument is remotely controlled via the USB/LAN/RS-232/GPIB interface, the panel lock is automatically enabled.

---

<b>Interface Configuration .....</b>	<b>132</b>
USB Remote Interface - Optional.....	132
RS-232 Remote Interface - Optional .....	133
RS-232/USB Remote Control Function Check.....	136
Using Realterm to Establish a Remote Connection.....	137
Configure GPIB Interface - Optional.....	140
GPIB Function Check .....	141
Configure Ethernet Connection .....	144
Web Server Remote Control Function Check.....	146

## Interface Configuration

### USB Remote Interface - Optional

USB configuration	PC side connector	Type A, host
	APS-7000 side connector	Rear panel Type B, slave
	Speed	1.1/2.0 (full speed/auto speed)
	USB Class	CDC (communications device class)



**Note**

The RS-232/USB interface card (APS-002) must first be installed before the USB interface can be used for remote control. Please see page 30 for installation details.

**Steps**

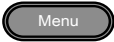
1. Connect the Type A-Type B USB cable from the PC to the rear panel USB B port. 
2. Press the *Menu* key. The Menu setting will appear on the display. 
3. Use the scroll wheel to go to item 6, *Rear USB* and press *Enter*.
4. Go to the *Speed* setting and set the USB speed.
 

Speed	Full, Auto
-------	------------
5. If the connection is successful *Connection Status* will change from Offline to Online.

Connection status

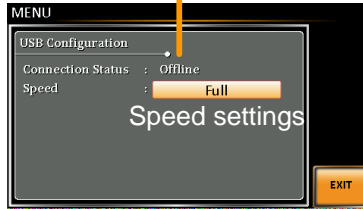

Exit

6. Press *Exit*[F4] to exit from the rear panel USB settings.



RS-232 Remote Interface - Optional

The APS-002 RS-232/USB interface card must be installed to remotely control the APS-7000 via the serial port.

---

RS-232 configuration	Connector	BD-9, male
	Parameters	Baud rate, data bits, parity, stop bits.

---

Pin Assignment

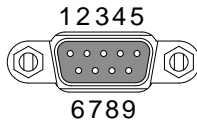

- 2: RxD (Receive data)
  - 3: TxD (Transmit data)
  - 5: GND
  - 4, 6 ~ 9: No connection
- 

Pin Connection

Use a Null Modem connection (RS-232C cable) as shown in the diagram below.

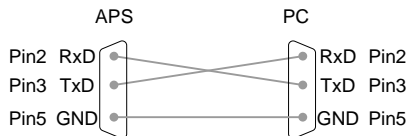



Note

The RS-232/USB interface card (APS-002) must first be installed before the USB interface can be used for remote control. Please see page 30 for installation details.

Steps

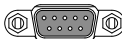
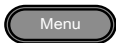
1. Connect the RS-232C cable from the PC to the rear panel RS-232 port. 
2. Press the *Menu* key. The Menu setting will appear on the display. 
3. Use the scroll wheel to go to item 7, *Serial Port* and press *Enter*.
4. Go to the *Function Active* setting and turn the serial port connection on.

Function Active	ON, OFF
-----------------	---------

5. Set the remaining serial port settings.

Baud rate	1200, 2400, 4800, 9600(default), 19200, 38400, 57600, 115200,
Data bits	7, 8(default)
Parity	None(default), odd, even
Stop bits	1(default),2

### Serial port configuration

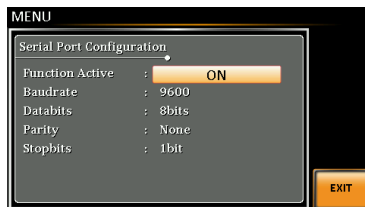

Exit

6. Press *Exit*[F4] to exit from the serial port settings.



---

## RS-232/USB Remote Control Function Check

---

Functionality  
check

Invoke a terminal application such as Realterm.

For both USB and RS-232, set the COM port, baud rate, stop bit, data bit and parity accordingly. The RS-232 settings are configured on the APS-7000. The UART settings for the USB connection can be seen in the Windows Device Manager.

To check the COM settings in Windows, see the Device Manager. For example, in WinXP go to the Control panel → System → Hardware tab.

---



Note

If you are not familiar with using a terminal application to send/receive remote commands from the serial port or via a USB connection, please see page 137 for more information.

---

Run this query command via the terminal after the instrument has been configured for RS-232/USB remote control (page 133, 132).

\*IDN?

This should return the Manufacturer, Model number, Serial number, and Software version in the following format.

```
GWINSTEK,APS-7050, GEXXXXXXX,  
XX.XX.XXXXXXX
```

```
Manufacturer: GWINSTEK  
Model number : APS-7050  
Serial number : GEXXXXXXX  
Software version : XX.XX.XXXXXXX
```

---





Note

For further details, please see the programming manual, available on the GW Instek web site @ [www.gwinstek.com](http://www.gwinstek.com).

---

## Using Realterm to Establish a Remote Connection

---

### Background

Realterm is a terminal program that can be used to communicate with a device attached to the serial port of a PC or via an emulated serial port via USB.

The following instructions apply to version 2.0.0.70. Even though Realterm is used as an example to establish a remote connection, any terminal program can be used that has similar functionality.

---



Note

Realterm can be downloaded on Sourceforge.net free of charge.

For more information please see <http://realterm.sourceforge.net/>

---

### Operation

1. Download Realterm and install according to the instructions on the Realterm website.
2. Connect the APS-7000 via USB (page 132) or via RS-232 (page 133).
3. If using RS-232, make note of the configured baud rate, stop bits and parity.
4. Go to the Windows device manager and find the COM port number for the connection. For example, go to the Start menu > Control Panel > Device Manager.

Double click the *Ports* icon to reveal the connected serial port devices and the COM port for the each connected device.

If using USB, the baud rate, stop bit and parity settings can be viewed by right-clicking the connected device and selecting the *Properties* option.

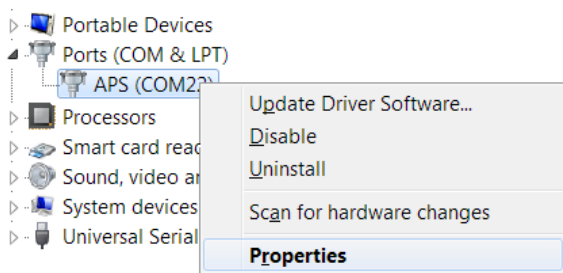

5. Start Realterm on the PC as an administrator.  
Click:  
Start menu>All Programs>RealTerm>realterm

Tip: to run as an administrator, you can right click the Realterm icon in the Windows Start menu and select the *Run as Administrator* option.

6. After Realterm has started, click on the *Port* tab.

Enter the *Baud*, *Parity*, *Data bits*, *Stop bits* and *Port* number configuration for the connection.

The *Hardware Flow Control*, *Software Flow Control* options can be left at the default settings.

Press *Open* to connect to the APS-7000.

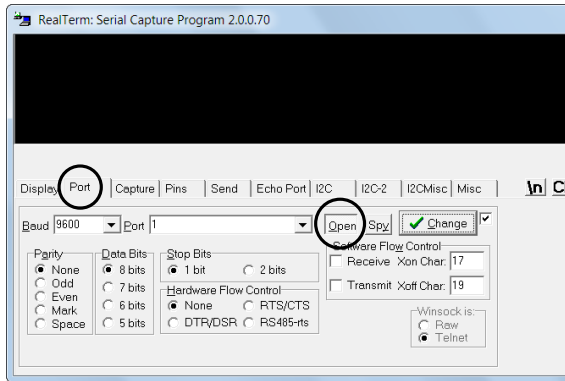

7. Click on the *Send* tab.

In the *EOL* configuration, check on the *+LF* check boxes.

Enter the query:

*\*idn?*

Click on *Send ASCII*.

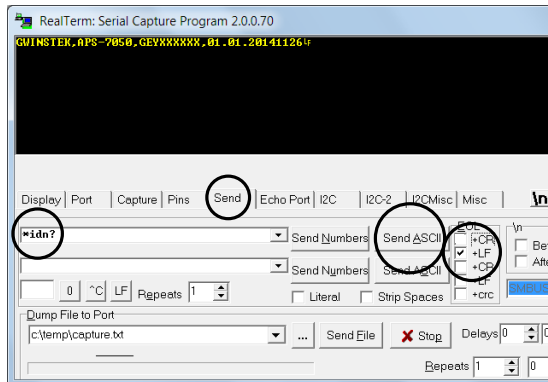

8. The terminal display will return the following:

*GWINSTEK,APS-7050, GEXXXXXXXXX,  
XX.XX.XXXXXXXXXX*

(manufacturer, model, serial number, software version)

9. If Realterm fails to connect to the APS-7000, please check all the cables and settings and try again.

## Configure GPIB Interface - Optional

To use GPIB, the optional APS-001 GPIB interface card must first be installed.



Note

The GPIB interface card (APS-001) must first be installed before the GPIB interface can be used for remote control. Please see page 30 for installation details.

GPIB Configuration

1. Connect a GPIB cable from the PC to the GPIB on the interface card.

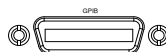

2. Press the *Menu* key. The Menu setting will appear on the display.

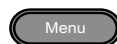

3. Use the scroll wheel to go to item 8, *GPIB* and press *Enter*.
4. If the GPIB card is installed successfully, the *Card Status* will show *Plugged in*.
5. Go to the *Function Active* setting and turn the GPIB port on.

Function Active	ON, OFF
-----------------	---------

6. Set the GPIB address.

GPIB Address	0 ~ 30
--------------	--------

### GPIB port configuration

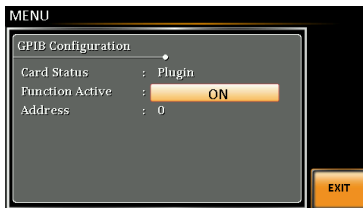

Exit 7. Press *Exit*[F4] to exit from the serial port settings. 

- GPIB constraints
- Maximum 15 devices altogether, 20m cable length, 2m between each device
  - Unique address assigned to each device
  - At least 2/3 of the devices turned On
  - No loop or parallel connection

### GPIB Function Check

Functionality check Please use the National Instruments Measurement & Automation Controller software to confirm GPIB/LAN functionality.

See the National Instrument website, <http://www.ni.com> for details.

 **Note** For further details, please see the programming manual, available on the GW Instek web site @ [www.gwinstek.com](http://www.gwinstek.com).

Operation 1. Start the NI Measurement and Automation Explorer (MAX) program. Using Windows, press: 

*Start>All Programs>NI MAX*

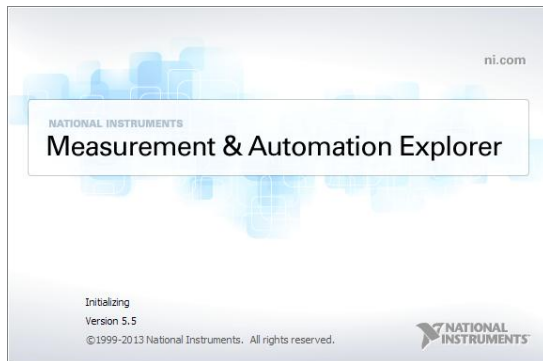

2. From the Configuration panel access;  
My System>Devices and Interfaces>GPIB0
3. Press the *Scan for Instruments* button.
4. In the *Connected Instruments* panel the APS-7000 should be detected as *Instrument 0* with the address the same as that configured on the APS-7000.
5. Double click the *Instrument 0* icon.

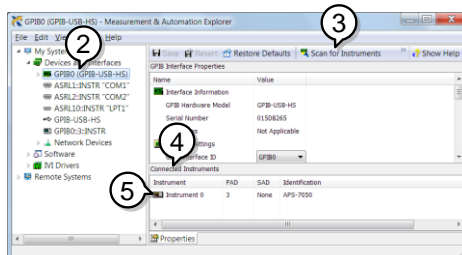

6. Click on *Visa Properties*.
7. Click on *Open Visa Test Panel*.

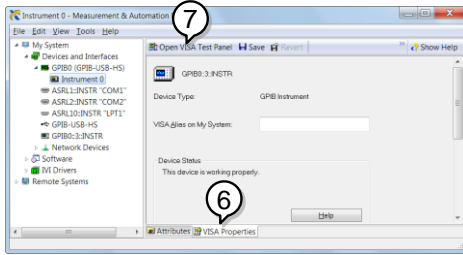

8. Click on the *Input/Output* icon.
9. Under the Basic I/O tab, ensure *\*IDN?* is written in the *Select or Enter Command* text box.
10. Click on the *Query* button to send the *\*IDN?* query to the instrument.
11. The instrument identification string will be returned to the buffer area:

*GWINSTEK,APS-7050, GEXXXXXXXX,  
XX.XX.XXXXXXXXXX*

(manufacturer, model, serial number, software version)



12. The function check is complete.



## Configure Ethernet Connection

The Ethernet interface can be configured for a number of different applications. Ethernet can be configured for basic remote control or monitoring using a web server or it can be configured as a socket server.

The APS-7000 supports both DHCP connections so the instrument can be automatically connected to an existing network or alternatively, network settings can be manually configured.

Ethernet Parameters	MAC Address (display only)	DHCP
	IP Address	Subnet Mask
	Gateway	DNS Address
	DNS Server	Socket port fixed at 2268

### Ethernet Configuration

1. Connect a LAN cable from the PC to the Ethernet port on the rear panel. 
2. Press the *Menu* key. The Menu setting will appear on the display. 
3. Use the scroll wheel to go to item 5, *LAN* and press *Enter*.
4. If the LAN cable is installed correctly a connection is active, the *Connection Status* will show *Online*.
5. To automatically have the network assign an IP address, set DHCP to ON. Otherwise set DHCP to OFF to manually set the Ethernet settings.

---

DHCP	ON, OFF
------	---------

---



6. If DHCP was set to OFF, configure the remaining LAN parameters.

\_\_\_\_\_

IP Address

\_\_\_\_\_

Subnet Mask

\_\_\_\_\_

Gateway

\_\_\_\_\_

DNS Server

\_\_\_\_\_

**LAN configuration**

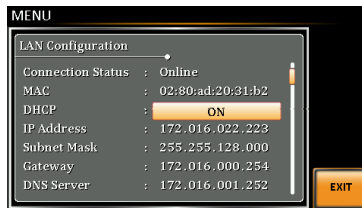

Exit

7. Press *Exit*[F4] to exit from the LAN settings.



## Web Server Remote Control Function Check

Functionality check

Enter the IP address of the power supply (for example: http:// XXX.XXX.XXX.XXX) in a web browser after the instrument has been configured for LAN(page 144).

The web interface allows you to:

- View the system and information and the network configuration.
- View the analog control pinout.
- View the dimensions of the unit.
- View the operating area

Example:

The screenshot shows the GW INSTEK web interface. At the top left is the logo "GW INSTEK" with the tagline "Made to Measure". To the right are links for "Visit Our Site", "Support", and "Contact Us". The main content area is divided into several sections:

- Welcome Page**: A simple text-based section.
- Network Configuration**: A section with a dashed border containing a table of network settings:
 

IP Address:	172.16.5.125
Subnet Mask:	255.255.128.0
Gateway:	172.16.0.254
DNS:	172.16.1.252
DHCP State:	<input type="radio"/> ON <input checked="" type="radio"/> OFF
- Analog Control**: A section with a "Password:" label and an empty input field.
- Figure of Dimensions**: A section with a "Password:" label and an empty input field.
- Operating Area**: A section with a "Submit" button.

## Socket Server Function Check

---

**Background** To test the socket server functionality, National Instruments Measurement and Automation Explorer can be used. This program is available on the NI website, [www.ni.com](http://www.ni.com), via a search for the VISA Run-time Engine page, or “downloads” at the following URL, <http://www.ni.com/visa/>

---

**Requirements** Firmware: V1.12  
Operating System: Windows XP, 7, 8, 8.1

---

**Functionality check** 1. Start the NI Measurement and Automation Explorer (MAX) program. Using Windows, press:

*Start>All Programs>NI MAX*



2. From the Configuration panel access;

*My System>Devices and Interfaces>Network Devices*

3. Press *Add New Network Device>Visa TCP/IP*

*Resource...*

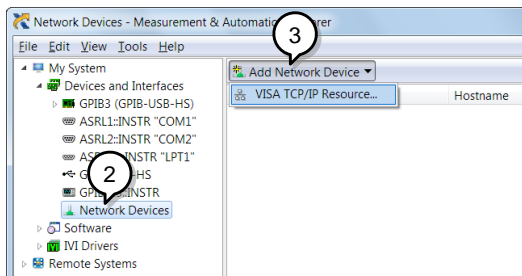

4. Select *Manual Entry of Raw Socket* from the popup window.

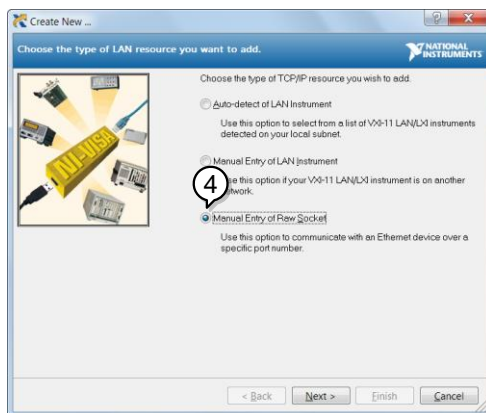

5. Enter the IP address and the port number of the APS-7000. The port number is fixed at 2268.
6. Double click the Validate button and press *Next*.

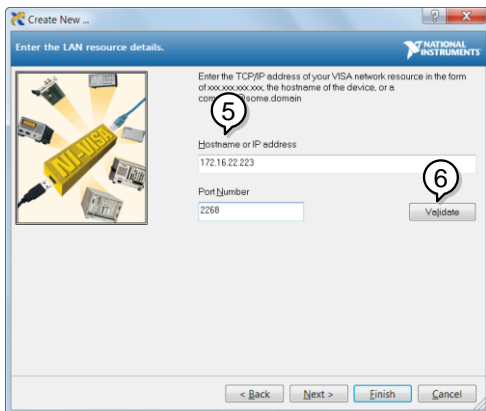

7. Next configure the Alias (name) of the APS-7000 connection. In this example the Alias is: APS
8. Click finish.

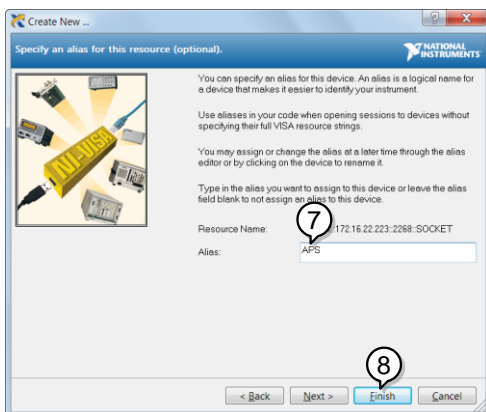

9. The IP address of the power supply will now appear under Network Devices in the configuration panel. Select this icon now.
10. Press *Open VISA Test Panel*.

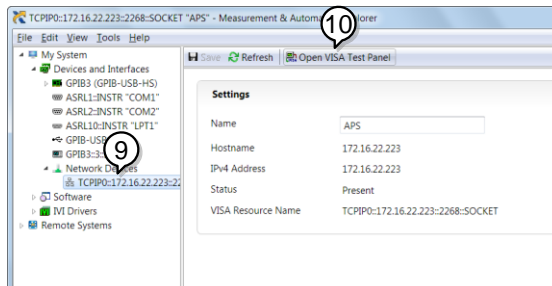

11. Click the *Configuration* Icon. Under the *IO Settings* tab check *Enable Termination Character*. The termination character should be set as *Line Feed - \n*.

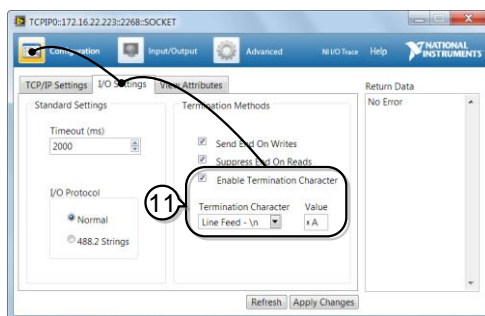

12. Click the *Input/Output* icon. Under the *Basic I/O* tab, make sure *\*IDN?\n* is entered in the *Select or Enter Command* drop box.

13. Click *Query*.

The APS-7000 will return the machine identification string into the buffer area:  
*GWINSTEK,APS-7050, GEXXXXXXX,  
 XX.XX.XXXXXXXX*

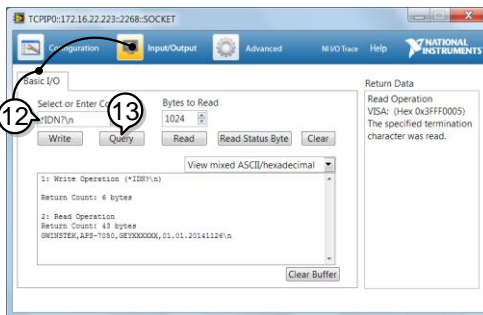

 Note

For further details, please see the programming manual, available on the GW Instek web site @ [www.gwinstek.com](http://www.gwinstek.com).

# FAQ

---

- The accuracy does not match the specification.

The accuracy does not match the specification.

---

Make sure the device is powered On for at least 30 minutes, within +18°C~+28°C. This is necessary to stabilize the unit to match the specification.

For more information, contact your local dealer or GWInstek at [www.gwinstek.com](http://www.gwinstek.com) / [marketing@goodwill.com.tw](mailto:marketing@goodwill.com.tw).



# A PPENDIX

## Firmware Update

---

**Background**                      The APS-7000 firmware can be upgraded using the USB A port on the front panel. See your local distributor or the GW Instek website for the latest firmware information.

---



- Ensure the DUT is not connected.
  - Ensure the output is off.
- 

**Steps**

1. Insert a USB Flash Drive into the USB port on front panel of the APS-7000.
  - The USB drive should include the **gw.sbt** file in a directory name “gw”(USB\gw:).
2. Press the *Menu* key. The Menu setting will appear on the display. 
3. Use the scroll wheel to go to item 11, *Special Function* and press *Enter*.
4. Enter the password and then press *Enter*.
  - Please see your local distributor for the password for your device.
5. Go to Item 1, *Update Main Program* and press *Enter*.

Exit

6. Wait for the unit to update. Upon completion the unit will automatically reset.
- 

Example

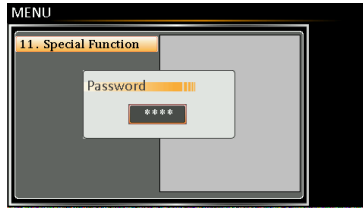

Password setting screen

## APS-7000 Default Settings

The following default settings are the factory configuration settings for the power supply.

For details on how to return to the factory default settings, see page 37.

Continuous Mode	APS-7050	APS-7100
Range		155V
ACV		0.00V
FREQ		60.00Hz
IRMS	4.20A	8.40A
ON PHS		0°
OFF PHS		0°
V limit		155.0Vrms
F Limit		500.0Hz
Ipeak Limit	16.80Arms	33.60Arms

Simulation Mode	APS-7050	APS-7100
Step		Initial
Repeat		1
Time		0.10s
ON Phs		ON, 0
Vset		0.00
OFF Phs		ON, 0
Fset		50.00
Trig Out		LO
Range		HI

Sequence Mode	APS-7050	APS-7100
Step		0
Time		0.10s
Jump To		ON, 1
Jump Cnt		1
Branch1		OFF
Branch2		OFF
Term		CONTI
Trig Out		LO

ON Phs	OFF
OFF Phs	OFF
Vset	0.00, CT
Fset	50.00

Program Mode	APS-7050	APS-7100
Not applicable		

Configuration Menu	APS-7050	APS-7100
Surge/Dip Control		OFF
Ramp Control		OFF
T ipeak, hold(msec)		1ms
Power ON Output		OFF
Buzzer		ON
SCPI Emulation		GW
Program Timer		SEC (seconds)
LAN, Rear USB, Serial Port, GPIB		N/A
LCD Contrast		50%
LCD Brightness		50%
LCD Saturation		50%

## APS-7000 Specifications

The specifications apply when the APS-7000 is powered on for at least 30 minutes. Note that the high frequency and high voltage options are listed as separate specifications.

### Standard APS-7000

Model	APS-7050	APS-7100
<b>AC Input</b>		
Phase	Single Phase	
Voltage	115/230 Vac $\pm$ 15%	
Frequency	47 ~ 63 Hz	
Max. Current	16A / 8A	32A / 16A
Power Factor	0.7 Typ.	
<b>AC Output</b>		
Power Rating	500 VA	1000 VA
Output Voltage	0 ~ 155Vrms / 0 ~ 310.0 Vrms	
Output Frequency	45.00 ~ 500.0 Hz	
Maximum Current (r.m.s) <sup>*1</sup>		
0 ~ 155 Vrms	4.2 A	8.4 A
0 ~ 310 Vrms	2.1 A	4.2 A
Maximum Current (peak)		
0 ~ 155 Vrms	16.8 A	33.6 A
0 ~ 310 Vrms	8.4 A	16.8 A
Phase	Single Phase, Two Wire (1P2W)	
Total harmonic distortion (THD) <sup>*2</sup>	$\leq$ 0.5% at 45 ~ 500Hz (Resistive Load)	
Crest factor	$\geq$ 4	
Line regulation	0.1% (% of full scale)	
Load regulation	0.5% (% of full scale)	
Response time	< 100 $\mu$ S	

Setting	
Voltage	
Range	0 ~ 155 Vrms, 0 ~ 310 Vrms, Auto
Resolution	0.01 V at 0.00 ~ 99.99 Vrms 0.1 V at 100.0 ~ 310.0 Vrms
Accuracy	± (0.5% of setting + 2 counts)
Frequency	
Range	45 ~ 500 Hz
Resolution	0.01 Hz at 45.00 ~ 99.99 Hz 0.1 Hz at 100.0 ~ 500.0 Hz
Accuracy	± 0.02% of Setting
Power on/off phase angle	
Range	0 ~ 359°
Resolution	1°
Accuracy	± 1° (45 ~ 65 Hz)
Measurement *3	
Voltage (r.m.s)	
Range	0.20 ~ 38.75 Vrms
	38.76 ~ 77.50 Vrms
	77.51 ~ 155.0 Vrms
	155.1 ~ 310.0 Vrms
Resolution	0.01 V at 0.00 ~ 99.99 Vrms 0.1 V at 100.0 ~ 310.0 Vrms
Accuracy *4	± (0.5% of reading + 2 counts)
Frequency	
Range	45 ~ 500 Hz
Resolution	0.01 Hz at 45.00 ~ 99.99 Hz 0.1 Hz at 100.0 ~ 500.0 Hz
Accuracy	± 0.1 Hz
Current (r.m.s)	
Range	2.00 ~ 70.00 mA
	60.0 ~ 350.0 mA
	0.300 ~ 3.500 A
	3.00 ~ 17.50 A
Resolution	0.01 mA
	0.1 mA
	0.001 A
	0.01 A
Accuracy	± (0.6% of reading + 5 counts), 2.00 ~ 350.0 mA ± (0.5% of reading + 5 counts), 0.350 ~ 3.500 A ± (0.5% of reading + 3 counts), 3.500 ~ 17.50 A

Measurement continued next page.

Current (peak)	
Range	0.0 ~ 70.0 A
Resolution	0.1 A
Accuracy	$\pm$ (1% of reading + 1 count)
Power (W)	
	0.01 W
Resolution	0.1 W 1 W
Accuracy	$\pm$ (0.6% of reading + 5counts), 0.20 ~ 99.99 W $\pm$ (0.6% of reading + 5counts), 100.0 ~ 999.9 W $\pm$ (0.6% of reading + 2counts), 1000 ~ 9999 W
Apparent Power (VA)	
	0.01 VA
Resolution	0.1 VA 1 VA
Accuracy	$\pm$ (1% of reading + 5counts), 0.20 ~ 99.99 VA $\pm$ (1% of reading + 5counts), 100.0 ~ 999.9 VA $\pm$ (1% of reading + 2counts), 1000 ~ 9999 VA
Power Factor	
Resolution	0.001
Accuracy	$\pm$ 2% reading + 2 counts
Crest Factor	
Range	0.00 ~ 50.00
Resolution	0.01

<b>General</b>		
Remote output signal	Pass, Fail, Test-in Process, Trigger in, Trigger out, OUT ON/OFF	
Syncn output signal	Output Signal 10 V, BNC Type	
Number of Preset	10 (0~9 numeric keys)	
Protection	OCP, OPP, OHP and Alarm	
<b>Environmental Conditions</b>		
Operating temperature range	0 ~ +40 °C	
Storage temperature range	-10 ~ +70 °C	
Operating humidity range	20 ~ 80% RH (no condensation)	
Storage humidity range	80% RH or less (no condensation)	
LCD Display	4.3 inch, 480 (RGB) x 272	
<b>Dimensions (mm)</b>		
W	430	430
H	88	88
D	400	560
Weight	24Kg	38Kg
<b>Sequence/Simulation Function</b>		
Number of Memories	10 (0~9 numeric keys)	
Number of Steps	255 max. (for 1 sequence)	
Step Time Setting Range	0.01 ~ 99.99 S	
Operation within Step	Constant, Keep, Linear Sweep	
Parameters	Ouput Range, Frequency, Waveform (sine wave only), On Phase, Off Phase, Term Jump Count (0 ~255), Jump-to, Branch 1, Branch 2, Trigger Output	
Sequence Control	Start, Stop, Hold, Continue, Branch 1, Branch 2	
<b>Interface</b>		
Standard	USB Host, LAN	
Optional	GPIB (APS-001) RS232 / USB CDC (APS-002)	



## APS-003 Option

Output Voltage 0 ~ 600 Vrms		
Model	APS-7050	APS-7100
Output		
Power Rating	500VA	1000VA
Maximum current (r.m.s) <sup>*5</sup> 0 ~ 600Vrms	1.05 A	2.1 A
Maximum current (peak) 0 ~ 600Vrms	4.2 A	8.4 A
Setting		
Voltage		
Range	0 ~ 155 Vrms, 0 ~ 310 Vrms, 0 ~ 600 Vrms, Auto	
Resolution	0.01V at 0.00 ~ 99.99 Vrms 0.1V at 100.0 ~ 600.0 Vrms	
Accuracy <sup>*6</sup>	± (0.5% of setting + 2 counts)	
Measurement <sup>*3</sup>		
Voltage (r.m.s)		
Range	0.2 ~ 600.0 Vrms	
Resolution	0.01V at 0.00 ~ 99.99 Vrms 0.1V at 100.0 ~ 600.0 Vrms	
Accuracy	± (0.5% of reading + 2 counts)	

## APS-004 Option

Output Frequency 45 ~ 999.9 Hz		
Model	APS-7050	APS-7100
Setting		
Frequency		
Range	45.00 ~ 999.9 Hz	
Resolution	0.01 Hz at 45.00 ~ 99.99 Hz 0.1 Hz at 100.0 ~ 999.9 Hz	
Accuracy	± 0.02% of Setting	
Measurement <sup>*3</sup>		
Frequency		
Range	45.00 ~ 999.9 Hz	
Resolution	0.01Hz at 45.00 ~ 99.99Hz 0.1Hz at 100.0 ~ 999.9Hz	
Accuracy	± 0.1 Hz	

Continued next page.

---

**AC Output**

---

Total harmonic distortion (THD) <sup>*7</sup>	≤0.5% at 45 ~ 999.9Hz (Resistive Load)
---	--

---

\*1 At working voltage 120V / 240V.

\*2 45 Hz to 500 Hz, 10% or higher of the rated output voltage, the maximum current or lower.

\*3 All of measurement accuracy is at 23±5°C.

\*4 In the case of 10 V to 155 V / 20 V to 310 V, sine wave, no load.

\*5 At working voltage 480V.

\*6 In the case of 40 V to 600 V, sine wave, no load.

\*7 45 Hz to 999.9 Hz, 10% or higher of the rated output voltage, the maximum current or lower.

# APS-7000 Dimensions

## APS-7050

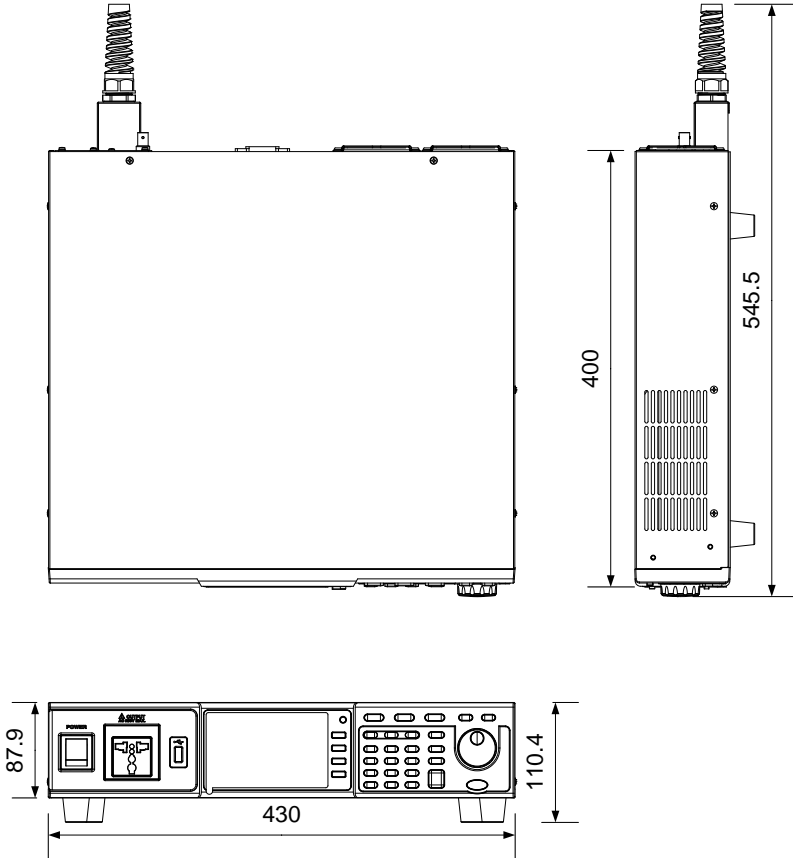

Scale = mm

**APS-7100**

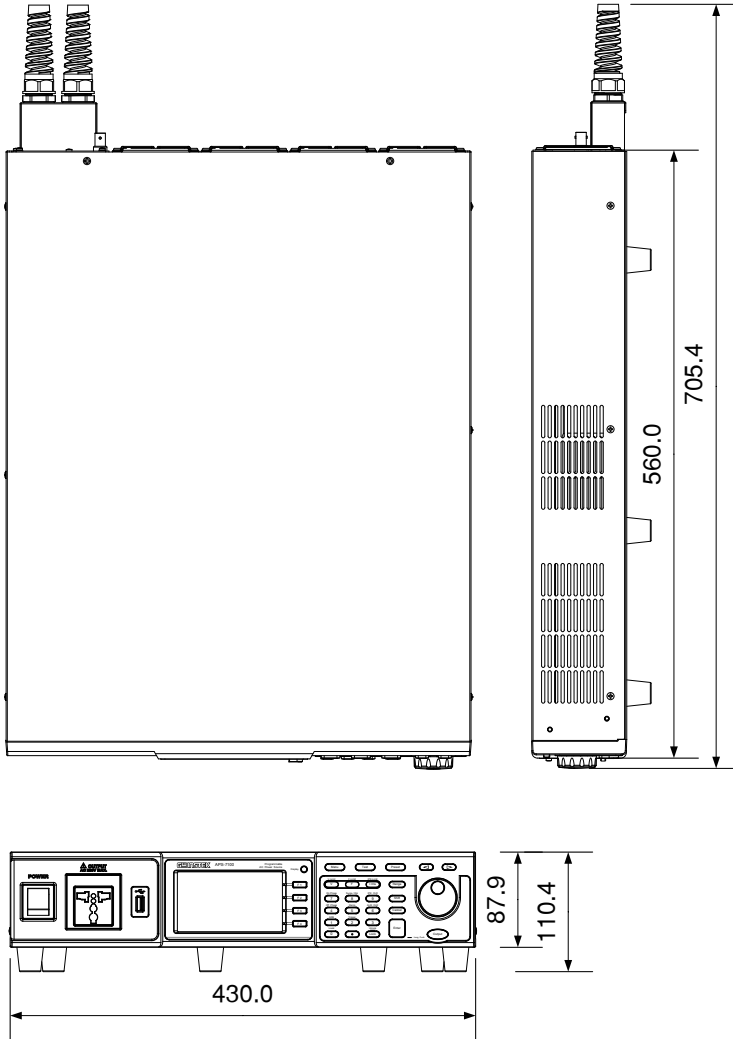

Scale = mm

## Declaration of Conformity

We

**GOOD WILL INSTRUMENT CO., LTD.**

No. 7-1, Jhongsing Rd, Tucheng Dist., New Taipei City 236, Taiwan

**GOOD WILL INSTRUMENT (SUZHOU) CO., LTD.**

No. 69 Lushan Road, Suzhou New District Jiangsu, China.

declare that the below mentioned product

**Type of Product: Programmable AC Power Source**

**Model Number: APS-7050, APS-7100**

are herewith confirmed to comply with the requirements set out in the Council Directive on the Approximation of the Law of Member States relating to Electromagnetic Compatibility (2004/108/EC) and Low Voltage Directive (2006/95/EC).

For the evaluation regarding the Electromagnetic Compatibility and Low Voltage Directive, the following standards were applied:

© EMC	
EN 61326-1: EN 61326-2-1:	Electrical equipment for measurement, control and laboratory use -- EMC requirements (2013)
Conducted & Radiated Emission EN 55011: 2009+A1:2010	Electrostatic Discharge EN 61000-4-2: 2009
Voltage Fluctuations EN 61000-3-11: 2000	Radiated Immunity EN 61000-4-3: 2006+A1:2008+A2:2010
-----	Electrical Fast Transients IEC 61000-4-4: 2012
-----	Surge Immunity EN 61000-4-5: 2006
-----	Conducted Susceptibility EN 61000-4-6: 2014
-----	Power Frequency Magnetic Field EN 61000-4-8: 2010
-----	Voltage Dip/ Interruption EN 61000-4-34: 2007+A1:2009

Low Voltage Equipment Directive 2006/95/EC	
Safety Requirements	EN 61010-1: 2010

# INDEX

Accessories .....	11	Ethernet	
Advanced settings		interface .....	144
Buzzer .....	71	Firmware update .....	153
miscellaneous .....	68	Frequency limit .....	47
Power output .....	70	Frequency output .....	48
Program timer unit .....	73	Front panel diagram .....	13
ramp .....	65	Ground	
SCPI emulation .....	42	symbol .....	4
surge/dip .....	61	I rms .....	52
T Ipeak .....	68	Ipk-Limit .....	49
trigger .....	74	I rms Delay time .....	53
Alarm clear .....	56	J1 connector	
Analog control		pin assignment .....	127
overview .....	126	LCD configuration .....	39
ARB .....	82	Line voltage	
Overview .....	83	1000VA models .....	22
Waveform .....	86	List of features .....	10
Build date		Load preset to local memory .....	79
view .....	38	Load preset to USB .....	80
Buzzer .....	71	Load program to USB .....	124
Caution symbol .....	4	Load sequence to USB .....	112
Cleaning the instrument .....	6	Load simulation to USB .....	99
clear alarm .....	56	Marketing	
Conventions .....	32	contact .....	152
Current RMS .....	52	Model differences .....	9
Declaration of conformity .....	165	Module installation .....	30
Default settings .....	155	OC fold .....	54
reset .....	37	On/off phase .....	55
Delay time .....	50	Output on .....	60
Delete program memory .....	124	Output terminals .....	26
Delete sequence memory .....	112	Panel lock .....	59
Delete simulation memory .....	99	Peak current limit .....	49
Display mode		Power on output .....	70
operation .....	57	Power on/off	
Disposal instructions .....	6	safety instruction .....	5
EN61010		Power up .....	25
measurement category .....	5	Preset settings .....	78
pollution degree .....	6	Program timer unit .....	73
Environment		Rack mount	
safety instruction .....	6		

description .....	32	System version	
Ramp control .....	65	view .....	38
Remote control .....	131	T Ipeak.....	68
Ethernet .....	144	Test	
GPIB.....	140	Overview .....	89
LAN .....	144	Program	
RS232 .....	133	Overview .....	116
USB .....	132	Recall .....	123
Remote control function check		Save.....	123
GPIB.....	141	Sequence	
Realterm.....	137	Overview .....	103
RS-232.....	136	Recall .....	111
USB .....	136	Run .....	114
Save preset to local memory ....	78	Save.....	111
Save preset to USB.....	80	Settings.....	107
Save program to USB .....	124	Simulation	
Save sequence to USB.....	112	Overview .....	91
Save simulation to USB.....	99	Recall .....	98
SCPI emulation .....	72	Run .....	101
Service operation		Save.....	98
about disassembly .....	5	Settings.....	95
contact .....	152	Trigger control.....	74
Signal output		Trigger in.....	75
pin assignment.....	129	Trigger out .....	76
Socket server function check ..	147	UK power cord.....	7
Specifications.....	157	Updating the firmware.....	153
Start/stop phase .....	55	USB driver installation .....	40
Surge/dip control .....	61	Voltage limit .....	44
SYNC output		Voltage output level .....	45
pin assignment.....	130	Voltage range.....	43
		Warning symbol.....	4
		Web server function check.....	146