



# Product Manual

*The Essential Guide for  
Safety Teams and  
Instrument Operators*

Part Number: 17154993-1  
Edition: 8  
April 30, 2018

**INDUSTRIAL**  

---

**SCIENTIFIC**

Industrial Scientific Corporation.

Pittsburgh, PA USA

Shanghai, China

© 2012, 2013, 2014, 2015, 2016, 2017, 2018 Industrial Scientific Corporation

All rights reserved. Published 2018

Revision 12



[www.indsci.com/TangoTX1](http://www.indsci.com/TangoTX1)

# Contents

Contents.....	iii
Tables and Figures .....	iv
Certifications .....	1
Product Overview.....	2
DualSense® Technology .....	2
Multiplane Sensor Ports and Data Memory .....	3
Dual-mode Operating System.....	3
Gas alert and alarm features .....	3
Other key features .....	3
Product Specifications .....	4
Introduction .....	7
Procedures.....	7
Recommendations .....	8
First Use.....	9
Wearing the Instrument.....	9
Unpacking the Instrument.....	11
Display Overview .....	13
Start-up and Shutdown .....	15
Configuration.....	17
Operation .....	27
Zero, Calibration, and Bump Test .....	30
Overview .....	33
Alarms.....	33
Warnings and failures .....	34
Service Instructions.....	37
Supplies .....	37
Three-dimensional Diagrams.....	38
Service Tasks .....	40
Warranty Policy.....	44
Limitation of Liability.....	44
Appendix .....	45
Marking Requirements.....	45
Contact Information.....	46

# Tables and Figures

Table 1.1 Certifications .....	1
Table 1.2 Warnings and cautionary statements.....	2
Table 1.3 Sensor-type options .....	2
Table 1.4 Instrument specifications .....	4
Table 1.5 Sensor specifications.....	5
Table 1.5 Sensor specifications.....	6
Table 1.6 Battery properties.....	6
Table 2.1 ISC recommended practices.....	8
Table 2.2 Securing the garment or belt clip .....	9
Table 3.1 Package contents .....	11
Table 3.2. Hardware overview .....	12
Table 3.3 Display screens, indicators and abbreviations.....	13
Table 3.4 Start-up and shutdown.....	15
Table 4.1 Configuration instruction .....	18
Table 4.2 Operation instruction.....	28
Table 4.3 Zero, calibration, and bump test .....	30
Table 4.3 Zero, calibration, and bump test .....	31
Table 4.3 Zero, calibration, and bump test .....	32
Table 5.1 Alarm Events (listed).....	34
Table 5.2 Warning (listed).....	35
Table 5.3 Warning and Failure Screens .....	35
Figure 6.1 Disassembled Tango TX1 .....	38
Figure 6.2 Disassembled Tango TX1 case top assembly.....	38
Table 6.1 Key for the Tango TX1 diagram.....	39
Table 6.2 Service tasks.....	40
Table A.1. Sensor cross interference (percent response) .....	45
Table A.2. ATEX and IECEx marking requirements .....	45

# General Information

Certifications

Product Overview

Product Specifications

## Certifications

Certifications for the Tango TX1®, at the time of this document's publication, are listed below in Tables 1.1. To determine the hazardous-area classifications for which an instrument is certified, refer to its label or the instrument order.









**Table 1.1 Certifications**

Directive or CB	Area Classifications	Approved Temperature Range
<i>Americas</i>		
CSA	Ex ia IIC T4; Class 1; Groups A, B, C, D; T4	-40 °C to +50 °C (-40 °F to +122 °F)
IECEX	Ex ia I Ma Ex ia IIC T4 Ga	-40 °C to +50 °C (-40 °F to +122 °F)
INMETRO	Ex ia IIC T4 Ga Ex ia I Ma	-40 °C to +50 °C (-40 °F to +122 °F)
UL	Class I, Zone 0, AEx ia IIC T4 Class II, Groups E, F, G	-40 °C to +50 °C (-40 °F to +122 °F)
<i>Europe and Russia</i>		
ATEX	Ex ia I Ma Ex ia IIC T4 Ga Equipment Groups and Categories: I M1 and II 1G	-40 °C to +50 °C (-40 °F to +122 °F)
GOST EAC	PO Ex ia I X 0 Ex ia IIC T4 X	-40 °C to +50 °C (-40 °F to +122 °F)
GOST-R, -UA	Metrology Pattern Approval	-20 °C to +50 °C (-4 °F to +122 °F)
<i>Asia and Pacific</i>		
China Ex	Ex ia IIC T4 Ga	-20 °C to +50 °C (-4 °F to +122 °F)
CMA	Ex ia I Ma	-20°C ≤ Ta ≤ +50°C (-4 °F ≤ Ta ≤ +122 °F)

Note: See the Appendix for ATEX and IECEX marking requirements.

Failure to perform certain procedures or note certain conditions may impair the performance of this product. For maximum safety and optimal performance, please read and follow the procedures and conditions listed below.

**Table 1.2 Warnings and cautionary statements**

-  For maximum safety and optimal performance, read and understand the manual before operating or servicing the unit. Failure to perform certain procedures or note certain conditions may impair the performance of this product.
-  For safety reasons, this equipment must be operated and serviced by qualified personnel only.
-  Substitution of components may impair intrinsic safety and may cause an unsafe condition.
-  Do not replace battery in hazardous locations. Only certified for use with one Tadiran TL-5955 battery cell.
-  Obstruction of sensor openings – due to dust, dirt, water, or another cause – can inhibit the unit's ability to measure gas concentrations accurately. When this occurs, readings may appear lower than the actual gas concentration. Keep sensor openings clean, dry, and properly exposed to the ambient air.
-  Obstructed, contaminated, or damaged sensor water barriers (or their gaskets) can inhibit the unit's ability to measure gas concentrations accurately. When this occurs, readings may appear lower than the actual gas concentration. Replace the sensor water barriers and gaskets as needed (see "Service" for instructions).
-  Service the unit, use its communications port, and change its battery cell only in nonhazardous locations. Not for use in oxygen-enriched atmospheres.
-  Contact your service representative immediately if you suspect that the unit is working abnormally.

## Product Overview

The Tango TX1 is a portable, long-life, single-gas monitor (instrument) for personal protection. It is a diffusion instrument for use in detecting and measuring gas present in open space. Based on the customer's order, two redundant sensors – sensors of the same type – are factory installed. Five sensor types are available (see Table 1.3).

**Table 1.3 Sensor-type options**

Sensor Category	Number of sensors available per instrument	Sensor type
Toxic	Two of the same type	Carbon Monoxide (CO) only, Hydrogen Sulfide (H <sub>2</sub> S) only, Nitrogen Dioxide (NO <sub>2</sub> ) only, Sulfur Dioxide (SO <sub>2</sub> ) only, <i>or</i> Carbon Monoxide with H <sub>2</sub> Low Interference (CO/H <sub>2</sub> Low) only.

*Note:* See Table 1.5 for sensor specifications.

## DUALSENSE® TECHNOLOGY

DualSense® Technology enables the use of redundant sensors, two installed sensors of the same type that are DualSense capable. The DualSense sensors measure the target gas concentration in the atmosphere at the same time, but operate independently of each other. Using a proprietary algorithm, the instrument

processes each sensor's data to display a single gas reading, while maintaining data logs for each sensor and for the derived DualSense "virtual" sensor.

Each sensor will revert to operate as a single sensor in the event its redundant sensor fails. This allows the instrument to continue operation until the failed sensor can be replaced.

## MULTIPLANE SENSOR PORTS AND DATA MEMORY

The Tango TX1's multi-plane sensor ports each sample air from three directions; this promotes continuous operation if one or two planes become obstructed. Since the TX1 measures gas at two second intervals, and continuously logs data every ten seconds, the data log can store approximately three months of data for a unit that is on 24 hours a day and has two installed, operational sensors. As the newest data are logged to memory, the oldest data are overwritten. The data log's date- and time-stamped event log records and stores event data for 60 alarm events and 30 error events. It also stores the data for up to 250 manual calibrations and bump tests. The data log is downloaded when the unit is docked in a compatible docking station.

## DUAL-MODE OPERATING SYSTEM

The instrument has two modes; configuration and operation. When in *configuration mode*, a unit's settings can be manually edited. Entry to configuration mode can be security-code protected. When the instrument is on and is *not* in configuration mode, it is said to be in *operation mode*.

## GAS ALERT AND ALARM FEATURES

The Tango TX1 has a multisensory (audible, visual, and vibration), multilevel warning and alarm system. Warnings indicate a service need (calibration due) or an operating condition (confidence indicator). Alarms indicate potentially hazardous gas concentrations or system faults. The instrument also features a *country-of-origin* option that automatically sets the values for the low-gas and high-gas alarm setpoints for each of five different countries or regions; each alarm setpoint value can also be manually edited.

The optional "acknowledgeable gas-alert" feature warns the instrument operator of the presence of gas in concentrations that may be approaching the instrument's alarm setpoints. An alert can prompt the instrument operator to check the display screen for gas readings.

If the measurement of a detected gas in the atmosphere reaches the gas-alert setpoint, which is below the low-alarm setpoint, the gas alert is activated. The instrument operator can temporarily turn off an alert's signals for 30 minutes; the instrument will continue to monitor for gas, display readings, and activate any alarms or other gas alerts that may occur.

After thirty minutes, if gas reading for the acknowledged alert has remained at (or again reached) the gas-alert setpoint, the alert signals will be reactivated.

The alarm-latch feature is used to keep an alarm on after the alarm-causing condition no longer exists. This serves to sustain alarm signals, which can encourage the instrument operator to check the display screen for gas readings, and to optionally release the alarm latch.

The always-on feature keeps the instrument from being shut down, without first entering the three-digit security code. This option can be enabled or disabled through the configuration mode.

## OTHER KEY FEATURES

The user interface consists of two buttons and an LCD (liquid crystal display). The buttons are used to power on and power off the instrument, navigate the operation and configuration loops, perform tasks, and access information. The unit can be set to display select information in English or French.

The unit's garment clip is intended for attachment to a garment; it is *not* intended for attachment to a belt or hard hat. An optional belt clip is available from ISC (see "Service"). An optional AlarmAmp™ is also available; when used, the audible alarm volume is increased by approximately 10 decibels (dB).

The Tango TX1 is iNet® ready and compatible with the Tango TX1 DSX docking stations.

## Product Specifications

Effective use of the Tango TX1 includes knowledge of the instrument's specifications and its sensor and battery specifications (see Tables 1.4 through 1.6).

---

**Table 1.4 Instrument specifications**

Item	Description
Display	Segment LCD
Keypad buttons	Two buttons
Case materials	Case top: polycarbonate with a protective rubber over-mold Case bottom: conductive polycarbonate
Alarms	Three strobe-emitting visual alarm LEDs (two red; one blue) 100 dB audible alarm at a distance of 10 cm (3.94"), typical Vibration alarm
Dimensions	99 x 51 x 35 mm (3.9" x 2.0" x 1.4")
Weight	126 g (4.4 oz.), typical
Ingress protection	IP66 and IP67
Operating temperature range <sup>1</sup>	-20 °C to +50 °C (-4 °F to +122 °F)
Operating humidity range	15 to 95% relative humidity (RH) noncondensing (continuous)

---

<sup>1</sup>Operating temperatures above 50 °C (122 °F) may cause reduced instrument accuracy. Operating temperatures below -20 °C (-4 °F) may cause reduced instrument accuracy and affect display and alarm performance.



Table 1.5 Sensor specifications

	Gas type (abbreviation) Part Number		
	Carbon Monoxide (CO)  17155161	Carbon Monoxide with low Hydrogen cross-sensitivity (CO/H <sub>2</sub> Low)  17155823	Hydrogen Sulfide (H <sub>2</sub> S)  17155164
<b>Properties</b>			
Category	Toxic	Toxic	Toxic
Technology	Electrochemical	Electrochemical	Electrochemical
DualSense <sup>®</sup> capable	Yes	Yes	Yes
<b>Operating conditions</b>			
Temperature range <sup>a</sup>	-40 to +50 °C (-40 to +122 °F)	-20 to +50 °C (-4 to +122 °F)	-40 to +50 °C (-40 to +122 °F)
RH range <sup>a</sup>	15-95%	15-95%	15-95%
<b>Performance</b>			
<i>Sensitivity</i>			
<i>Measurement range</i>	0–1000 ppm	0–1000 ppm	0–500 ppm
Measurement resolution	1 ppm	1 ppm	0.1 ppm
<b>Accuracy<sup>b</sup></b>			
Calibration gas and concentration	100 ppm CO	100 ppm CO	25 ppm H <sub>2</sub> S
Accuracy at time and temperature of calibration	± 5%	± 5% (0–300 ppm) ± 15% (301–1000 ppm)	± 5%
Accuracy over sensor's full temperature range	± 15%	± 15%	± 15%
<b>Response Time</b>			
T50	12 s	9 s	8 s
T90	48 s	18 s	20 s

**Table 1.5 Sensor specifications**

	Gas type (abbreviation)	
	Part number	
	Nitrogen Dioxide (NO <sub>2</sub> ) 17155162	Sulfur Dioxide (SO <sub>2</sub> ) 17155163
<b>Properties</b>		
Category	Toxic	Toxic
Technology	Electrochemical	Electrochemical
DualSense® capable	Yes	Yes
<b>Operating conditions</b>		
Temperature range <sup>a</sup>	-40 to +50 °C (-40 to +122 °F)	-20 to +50 °C (-4 to +122 °F)
RH range <sup>a</sup>	15-95%	15-95%
<b>Performance</b>		
<i>Sensitivity</i>		
Measurement range	0–150 ppm	0–150 ppm
Measurement resolution	0.1 ppm	0.1 ppm
<b>Accuracy<sup>b</sup></b>		
Calibration gas and concentration	25 ppm NO <sub>2</sub>	10 ppm SO <sub>2</sub>
Accuracy at time and temperature of calibration	± 10%	± 10%
Accuracy over sensor's full temperature range	± 15%	± 15%
<b>Response Time</b>		
T50	10 s	20 s
T90	30 s	80 s

<sup>a</sup>During continuous operation.

<sup>b</sup>Apply when the instrument is calibrated using the stated calibration gas and concentration; accuracy is equal to the stated percentage or one unit of resolution, whichever is greater.

*Note:* See the Appendix for supplemental information about sensor types and gases.

**Table 1.6 Battery properties**

Battery Pack	Properties
3.6 V Primary Lithium-thionyl chloride (Li-SOCl <sub>2</sub> ), 1.5AH, 2/3AA	Replaceable* Nonrechargeable Two-year run time depending on operating conditions; the amount of time the unit is in alarm; and the enablement of unit's confidence indicator, bump test due alert, calibration due alert, and gas-alert.

\* See "Service" for instructions. Some restrictions may apply (see "Introduction", Table 1.2 Warnings and cautionary statements).

---

# Recommended Practices

Introduction

Procedures

Recommendations

First Use

Wearing the Instrument

---

## Introduction

Gas detection instruments are potentially life-saving devices. When completed regularly, the procedures defined below help to maintain proper instrument functionality and enhance operator safety.

## Procedures

**Configuration.** The configuration process allows qualified personnel to review and adjust a unit's settings.

**Self-test.** The self-test verifies the functionality of the instrument's memory operations, battery, and each alarm indicator (audible, visual, and vibration).

**Bump Test.** Bump testing is a functional test in which an instrument's installed sensors are to be briefly exposed to (or "bumped" by) calibration gases in concentrations that are greater than the sensors' low-alarm setpoints. This will cause the instrument to go into low alarm and will indicate which sensors pass or fail this basic test for response to gas.

**Zero.** Zeroing adjusts the sensors' "baseline" readings, which become the points of comparison for subsequent gas readings. It is a prerequisite for calibration. During zeroing, the installed sensors are to be exposed to an air sample from a zero-grade-air cylinder or ambient air that is known to be clean air. If there are gases in the air sample that are below the lowest alarm level, the instrument will read them as zero; its task is to read the air sample as clean air. The user's task is to ensure the air is clean.

**Calibration.** Regular calibrations promote the accurate measurement of gas concentration values. During calibration, an instrument's installed sensors are to be exposed to their set concentrations of calibration gases. Based on the sensors' responses, the instrument will self-adjust to compensate for declining sensor sensitivity, which naturally occurs as the installed sensors are used or "consumed".

**Docking.** When docked, instruments that are supported by iNet® Control or DSSAC (Docking Station Software Admin Console) will be maintained for all scheduled bump tests and calibrations, synchronized for any changes to settings, and upgraded for improvements from Industrial Scientific.

**Other Maintenance.** The time-weighted average (TWA), short-term exposure limit (STEL), and peak readings can each be "cleared". When any summary reading is cleared, its value is reset to zero and its time-related setting is also reset to zero.

*Note:* The peak readings and the data log readings are stored independently of one another; therefore, clearing the peak reading does not affect the data log. Powering the instrument off or changing its battery does not affect the peak reading. These checks and balances help promote operator safety, and serve to contain the peak readings in a "black-box" manner. In the event of a gas-related incident, this black-box record can be useful to the safety team or a prospective investigator.

## Recommendations

Industrial Scientific Corporation (ISC) minimum frequency recommendations for each procedure are summarized in the table below. These recommendations are based on field data, safe work procedures, industry best practices, and regulatory standards to help ensure worker safety. Industrial Scientific is not responsible for setting safety practices and policies.

ISC recommendations include a daily bump test for any ISC instrument that is *not* operating on DualSense technology. This includes the Tango TX1 when it is operating with only one working sensor.

When two redundant, working sensors are installed in the Tango TX1, the instrument *is* operating on DualSense and the probability of sensor failure – compared with a single-sensor instrument – is diminished regardless of bump test frequency.

When two sensors of the same type are operating on DualSense and one sensor needs to be replaced, replace both sensors at the same time.

The frequency of bump testing for DualSense instruments, between monthly calibrations, is best determined by a company's safety policies. These policies may be affected by the directives and recommendations of regulatory groups, environmental conditions, operating conditions, instrument use patterns and exposure to gas, and other factors.

**Table 2.1 ISC recommended practices**

Procedure	Recommended minimum frequency
<b>DualSense instruments</b>	
Configuration	Before first use, when there is a change in the installed sensor type, and as otherwise needed.
Calibration <sup>a</sup>	Before first use and monthly thereafter.
Bump test <sup>b</sup>	As desired between monthly calibrations.
Self-test <sup>c</sup>	Prior to each day's use for a unit that is always on or is left on.
<b>Non-DualSense instruments</b>	
Configuration	Before first use and as needed thereafter.
Calibration <sup>a</sup>	Before first use and monthly thereafter.
Bump test <sup>b</sup>	Prior to each day's use.
Self-test <sup>c</sup>	As desired between daily bump tests.

<sup>a</sup>Between regular calibrations, ISC also recommends a calibration be performed immediately following each of these incidences: the unit falls, is dropped, or experiences another significant impact; is exposed to water; fails a bump test; or has been repeatedly exposed to an over-range (positive or negative) gas concentration. A calibration is also recommended after the installation of a new (or replacement) sensor.

<sup>b</sup>If conditions do not permit daily bump testing, the procedure may be done less frequently based on company safety policy.

<sup>c</sup>The Tango TX1 self-test is performed automatically during the start-up process. It can be user-initiated from operation mode.

*Note:* The use of calibration gases not provided by ISC may void product warranties and limit potential liability claims.

# First Use

To prepare the Tango TX1 for first use, qualified personnel should configure and calibrate the unit.

## Wearing the Instrument

Based on the U.S. Department of Labor's Occupational Safety and Health Administration (OSHA) definition of the breathing zone, it is recommended that the unit be worn within a 25.4 cm (10") radius of the nose and mouth. Refer to OSHA and to other agencies or groups as needed for additional information.

ISC also recommends that the unit be worn within the instrument operator's sight line.

The instrument operator may wear the unit with its factory-installed garment clip or with the optional belt clip. The garment clip is solely intended for attachment to a garment. The *belt* clip may be attached to a hard hat, belt, or garment.

The clips should be securely fastened and attached in a manner that ensures the unit's sensor portals are fully exposed to the air. No part of the unit should be covered by any garment, part of a garment, or other item that would restrict the flow of air to the sensors or impair the operator's access to the audible, visual, or vibration alarms. Attach the desired clip as shown below.

---

**Table 2.2 Securing the garment or belt clip**

---

### Garment clip



Lift the clip cover.



Position the garment between the clip's upper and lower teeth. Press down on the clip cover to secure the clip in place.



—

---

### Belt clip



Position the hard hat or garment between the clip and clip back.



Slide the clip to secure it in place. The instrument can be worn right side up or upside down.

—



# Instrument Basics

Unpacking the Instrument

Hardware Overview

Display Overview

Start-up and Shutdown

## Unpacking the Instrument

The items that are shipped with the unit are listed below (see Table 3.1); each item should be accounted for in the unpacking process.

**Table 3.1 Package contents**

Quantity	Item	Notes
1 as ordered	Tango TX1	Part number 18109075
1	Garment clip (installed)	Optional belt clip sold separately.
1	Calibration cup	—
1	Calibration and bump test tubing	60.96 cm (2') of urethane tubing; 4.762 mm (3/16") ID
1	<i>Reference Guide</i>	Companion to the <i>Tango TX1 Product Manual</i>
1	<i>Final Inspection &amp; Test Report and Declaration of Conformity</i>	The <i>Final Inspection &amp; Test Report</i> includes these values: Unit setup date Unit part number Unit serial number For each sensor: <ul style="list-style-type: none"> <li>• Part number</li> <li>• Serial number</li> <li>• Type</li> <li>• Alarm settings<sup>1</sup></li> <li>• Span information<sup>1</sup></li> </ul>





<sup>1</sup>At the time of shipment.

*Note:* If any item is missing or appears to have been damaged, contact ISC (see "Contact Information") or a local distributor of ISC products.

# Hardware Overview

The instrument's main hardware components are identified below (see table 3.2).

Table 3.2. Hardware overview

Tango TX1	
<p>Visual alarm (or alert) indicator</p> <p>IrDA (infrared data exchange) window</p> <p>Sensor port 1 and dust filter</p> <p>Case top</p> <p>On-off-mode button </p> <p>LCD</p>	 <p>Visual alarm (or alert) indicators</p> <p>Sensor port 2 and dust filter</p> <p>Enter button </p> <p>Audible alarm (or alert) indicator and dust filter</p>
Case bottom	
	
Garment clip (closed)	Garment clip (open)



# Display Overview

The *visual test* screen shown below contains all the indicators that can appear on the display screen. Each indicator is stationary and appears only when relevant to the task being performed. For example, in the gas-monitoring screen shown below (numeric display), the following apply: the check mark indicates there are no sensor faults; the sensor-type icon indicates that H<sub>2</sub>S sensors are installed; the numeric display shows a gas reading of 5.1 ppm.

Table 3.3 Display screens, indicators and abbreviations

## Display screens



Visual test screen

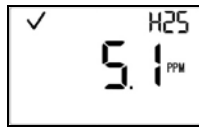

Gas-monitoring Screen  
(numeric display)

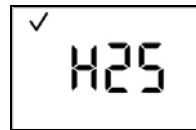

Gas-monitoring screen  
(text display)

## Status indicators

	only	Two sensors are installed and neither is in fault.
		Two sensors are installed and one is in fault; a sensor location icon also displays to indicate which sensor is in fault.
	and	Only one sensor is installed and is <i>not</i> in fault.
		Two sensors are installed and both are in fault or one sensor is installed and in fault. The warning icon is also used in combination with other indicators to communicate a system alarm or an alert condition.
		The unit is in configuration mode.



## Alarm indicators

		The alarm icon is used in combination with other indicators to communicate a variety of conditions.
	and ▲	High-level gas alarm.
	and ▼	Low-level gas alarm.
	and STEL	STEL alarm.
	and TWA	TWA alarm.
	and	Positive over-range gas alarm.
	and	Negative over-range gas alarm.
		Low-battery alarm.

## Process and time-based indicators

		The zero icon is used in combination with other indicators to communicate sensor zero information.
		The bump test icon is used in combination with other indicators to communicate bump test information.

Table 3.3 Display screens, indicators and abbreviations

	The calibration icon is used in combination with other indicators to communicate calibration information.
	A process is in progress. In configuration mode, indicates a time-based setting (e.g. bump test response time).
	Used in combination with other indicators to communicate maintenance required warnings. In configuration mode, indicates a date-based setting (e.g., bump test interval).



**Gas name and unit-of-measure abbreviations**

CO	Carbon Monoxide (CO)
SO2	Sulfur Dioxide (SO <sub>2</sub> or SO2)
NO2	Nitrogen Dioxide (NO <sub>2</sub> or NO2)
H2S	Hydrogen Sulfide (H <sub>2</sub> S or H2S)
CO <sub>L</sub>	Carbon Monoxide with H <sub>2</sub> Low Interference
PPM	Parts per million is the unit of measure for CO, CO/H <sub>2</sub> Low, SO <sub>2</sub> , NO <sub>2</sub> , and H <sub>2</sub> S.

**Configuration abbreviations**

SYnC	Dock "SYnC" Interval
M.n	Maintenance indicator interval
gAS	Enable Gas-alert
dDC	Dock Due option
CO <sub>n</sub>	Country of Origin
LA <sub>n</sub>	Language
d IS	Display Style
V 1b	Vibrating Alarm Enabled

**Other abbreviations**

STEL	Short-term exposure limit. Display variations: "STEL" (English) and "VLE" (French).
TWA	Time-weighted average. Display variations: "TWA" (English) and "VME" (French).
	Security code is set or to be entered. In configuration mode, indicates a feature may be operation-mode enabled or disabled.
	Peak reading.

# Start-up and Shutdown

The start-up and shutdown sequences are outlined below and feature reproductions of the display screens the instrument operator will see during these processes (see Table 3.4). Instructions accompany any display screen where the instrument operator must press a button to proceed.

The instrument operator may be prompted to complete the time- and date-setting tasks during start-up. This may happen after a battery has been removed or changed. If prompted by the unit to do so, it is essential – for data log accuracy – that the time- and date-setting tasks be completed. The data log plays an important role in preserving operator safety and in the prospective investigation of an incident.

The instrument operator may be prompted to enter a security code during shutdown. This will occur if the unit is configured for "always-on" and is security-code protected.

**Table 3.4 Start-up and shutdown**

### Start-up



Press and hold for three seconds, then release to initiate the start-up sequence and power on the unit.

- The instrument performs a self-test during start-up.
- If all start-up diagnostics pass, the audio, visual, and vibration indicators turn on then off. Several *start-up screens* display, followed by the *gas-monitoring screen*.
- If any start-up diagnostic fails, an error message displays (see "Alarms, Warnings and Notifications").
- To access Configuration mode, press and hold and at the same time, during the alarm information screen cycle.



Visual test screen



Version



Calibration date (last calibration date shown above)

### Gas Information screens (H<sub>2</sub>S shown.)



Calibration gas setpoint



Gas-alert setpoint  
(If enabled)



Low alarm setpoint



High alarm setpoint



TWA setpoint



STEL setpoint

---

## Shutdown

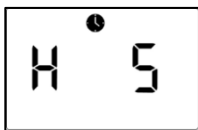

Countdown

Press and hold for five seconds.

After a five-second countdown:

The instrument powers off if;

- the always-on feature is *disabled* or
- the always-on feature is *enabled and* the security code is set to 000.



Enter security code

If this screen is activated, the shutdown process is security-code protected. To complete shutdown, the user must enter the correct three-digit code.

Value range: 000 to 999



Increments the value by one; hold to speed the increment pace.

Enters the value. If the value is correct, the unit powers off. If the value is incorrect, the gas-monitoring screen is activated. Dock the unit or store it for next use.

*Note:* When the instrument is powered off, it completes a battery self-check every 24 hours, briefly displaying a battery icon (  ). The icon displays only to indicate that the test has been performed; it is *not* indicative of the battery's charge level.

---

\*When editing a value, once the last value in the range is reached, the display starts again with the first value.

To prepare the instrument for first use, qualified personnel should proceed with the configuration process (see "Configuration").

To operate a field-ready unit, refer to "Operation".

---

# Instrument Preparation and Use

Configuration

Operation

Zero, Calibration, and Bump Testing

---

## Configuration

Read and understand all configuration instruction before configuring the unit.

As noted in "Recommended Practices", the unit should be configured before first use, when there is a change in the installed sensor type (e.g., H<sub>2</sub>S sensors are replaced with CO sensors), and as needed. Only qualified personnel should access the configuration mode and adjust the unit's settings.

Configuration mode can be accessed only during the start-up sequence (see "Start-up and Shutdown").

Review the unit's configured settings for compliance with company policy and any applicable regulations, laws, and guidelines as issued by regulatory agencies and government or industry groups. Determine which settings, if any, require adjustment.

Choose alarm- and warning-related options that maximize safety within the air-sampling environment.

When the unit is in configuration mode, the following apply:

- The tool icon (✕) displays in the lower right corner of each screen.
- With successive short presses of the on-off-mode button (⏻), the user can scroll through the configuration loop.
- The enter button (⏵) is used to start the editing process or start a task (e.g., zero).
- When editing a value, the enter button (⏵) increments the value and the on-off-mode button (⏻) saves the value.
- When editing a value, once the last value in the range is reached, the display starts again with the first value.
- When both buttons (⏻ and ⏵) are simultaneously pressed and held for three seconds, the unit leaves configuration mode; it enters operation mode and the gas-monitoring screen is activated.
- Unless otherwise noted, when no button is pressed for 30 seconds, the unit enters operation mode and the gas-monitoring screen is activated.

Any changes made in configuration mode are automatically saved to the unit and take effect immediately. Upon next docking, settings are updated according to the unit's settings in iNet Control.

The configuration-mode loop is outlined below (see Table 4.1). Instructions for button use accompany each configuration-mode display screen.









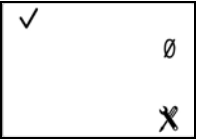

Setting Button	Description Button effect
 <p>Enter security code</p>	<p>If this display screen is activated, the configuration mode is security-code protected. To enter configuration, the user must enter the correct three-digit code.</p> <p>If the security code is set to 000, entry to configuration mode is <i>not</i> security-code protected. The first configuration-mode screen is activated, the initiate-zero screen.</p>
 	<p>Increments the value by one; hold to speed the increment pace.</p> <p>Saves the displayed value.</p> <p><i>Notes: If an incorrect code is entered, the unit does not enter configuration mode and the gas-monitoring screen is activated.</i></p>
 <p>Initiate zero</p>	<p>This screen's activation allows the technician to complete the zero and calibration processes from configuration mode.</p>
 	<p>Starts the zero process.</p> <p>Skips the zero process and activates the next configuration-mode screen.</p>
 <p>Low gas alarm setpoint</p>	<p><i>See also country-of-origin setting.</i></p> <p>This display screen features the status, low alarm, sensor-type, and configuration icons, with the alarm's current setpoint and unit of measure. The alarm setpoint can be edited based on the following:</p> <p>Value range = within the sensor measurement range            Value increment = sensor measurement resolution  <i>See Table 1.5 for the measurement range and resolution for the installed sensor type.</i></p>
 	<p>The first press activates the value. Continued presses increment the value; hold to speed the increment pace.</p> <p>One press saves the displayed value; a second press activates the next configuration-mode screen.</p>
 <p>High gas alarm setpoint</p>	<p><i>See also country-of-origin setting.</i></p> <p>This display screen features the status, high alarm, sensor-type, and configuration icons, with the alarm's current setpoint and unit of measure. The alarm setpoint can be edited based on the following:</p> <p>Value range = within the sensor measurement range            Value increment = sensor measurement resolution  <i>See Table 1.5 for the measurement range and resolution for the installed sensor type.</i></p>
 	<p>The first press activates the value. Continued presses increment the value; hold to speed the increment pace.</p> <p>One press saves the displayed value; a second press activates the next configuration-mode screen.</p>

Table 4.1 Configuration instruction



Setting Button	Description Button effect
 Gas-alert setpoint	<p>This display screen features the status, alarm, sensor type, and configuration icons, with the measurement unit and current setting. The gas-alert setpoint is less than the low alarm setpoint. When the value is set lower than the low gas alarm setpoint, the gas-alert will notify the operator before the low alarm notification.</p> <p>Value increment = within the sensor measurement range.  <i>See Table 1.5 for more information about the installed sensor type.</i></p> <p>The first press activates the value. Continued presses increment the value; hold to speed the increment pace.</p> <p>One press saves the displayed value and activates the next configuration-mode screen.</p>
 TWA operation-mode	<p>This display screen features the status, lock, configuration, and TWA icons. The technician can enable or disable the option for operation-mode access.</p> <p>When enabled, the instrument operator is permitted to view and clear the unit's TWA reading while the unit is in operation mode.</p> <p>Values:            0 = disabled            1 = enabled</p> <p>Increments the value.</p> <p>One press saves the displayed value and activates the next configuration-mode screen.</p>
 TWA alarm setpoint	<p>This display screen features the status, alarm, sensor-type, configuration, and TWA icons, with the alarm's current setpoint and unit of measure. The alarm setpoint can be edited.</p> <p>Value increment = within the sensor measurement resolution  <i>See Table 1.5 for more information about the installed sensor type.</i></p> <p>The first press activates the value. Continued presses increment the value; hold to speed the increment pace.</p> <p>One press saves the displayed value; a second press activates the next configuration-mode screen.</p>
 TWA time-base	<p>This display screen features the status, clock, configuration, and TWA icons, with the current TWA time-base. The setpoint value can be edited based on the following:</p> <p>Value range: 01 to 40 hours            Value increment: 1 hour</p> <p>The first press activates the value. Continued presses increment the value; hold to speed the increment pace.</p> <p>One press saves the displayed value; a second press activates the next configuration-mode screen.</p>

Table 4.1 Configuration instruction



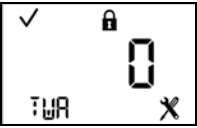

Setting Button	Description Button effect
 <p>STEL operation-mode</p>	<p>This display screen features the status, lock, configuration, and STEL icons. The technician can enable or disable the option for operation-mode access.</p> <p>When enabled, the instrument operator is permitted to view and clear the unit's STEL reading while the unit is in operation mode.</p> <p>Values: 0 = disabled 1 = enabled</p> <p>Increments the value.</p> <p>One press saves the displayed value and activates the next configuration-mode screen.</p>
 <p>STEL alarm setpoint</p>	<p>This display screen features the status, alarm, sensor type, configuration, and STEL icons, with the current setpoint. The alarm setpoint can be edited.</p> <p>Value increment: sensor measurement resolution See Table 1.5 for more information about the installed sensor type.</p> <p>The first press activates the value. Continued presses increment the value; hold to speed the increment pace.</p> <p>One press saves the displayed value; a second press activates the next configuration-mode screen.</p>
 <p>Calibration gas</p>	<p>This display screen features the status, sensor-type, configuration, and calibration icons, with the current calibration gas setting in the main area.</p> <p>This setting reflects the concentration of calibration gas that the instrument expects to read when calibrated; it should be edited to match the cylinder's gas concentration.</p> <p>Value range: within the sensor measurement range Value increment: sensor measurement resolution See Table 1.5 for the measurement range and resolution for each sensor type.</p> <p>Increments the value; hold to speed the increment pace.</p> <p>One press saves the displayed value; a second press activates the next configuration-mode screen.</p>
 <p>Time</p>	<p>This display screen features the status, clock, and configuration icons, with the current time setting.</p> <p>The instrument's clock uses a 24-hour time format. Its settings are edited in this order using these values: Hours: 00 to 24 Minutes: 00 to 59 Value increment: 1</p> <p>The first press activates the first value to be edited. Continued presses increment the value; hold to speed the increment pace.</p> <p>One press saves the displayed value and activates the next value to be edited. Continue to use the buttons,  and , to edit and save the values, respectively.</p> <p>After all values are edited and saved, one press activates the next configuration-mode screen.</p>



Table 4.1 Configuration instruction

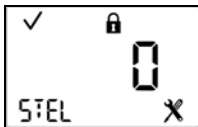

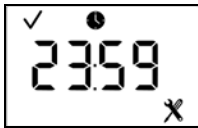

Setting Button	Description Button effect
 <p>Date</p>	<p>This display screen features the status, configuration, and calendar icons, with the current date setting. The year is displayed in the lower left corner. In the main display, the first two digits represent the date and the second two digits represent the month. The settings are edited in this order using these values:</p> <p>Year: 2012 to 2099            Day: 00 to 31            Month: 00 to 12</p> <p>The first press activates the first value to be edited. Continued presses increment the value; hold to speed the increment pace.</p> <p>One press saves the displayed value and activates the next value to be edited. Continue to use the buttons,  and , to edit and save the values, respectively.</p> <p>After all values are edited and saved, one press activates the next configuration-mode screen.</p>
 <p>Display</p>	<p>This display screen features the status, "DIS", and configuration icons, with the selection number in the main area. This setting allows the technician to choose the display style for the gas-monitoring screen. A numeric display will feature the numeric gas reading and the sensor type icon. A text display will feature the sensor type in place of the numeric gas reading (see "Operation" for sample display styles).</p> <p>Values:            0 = Numeric display            1 = Text display</p> <p>Increments the value.</p> <p>One press saves the displayed value and activates the next configuration-mode screen.</p>
 <p>Confidence indicator</p>	<p>This display screen features the status, alarm, and, configuration icons, with the selection number in the main area. The technician can disable or enable the indicator and choose the indicator type.</p> <p>When enabled, the unit will emit the selected signal every 90 seconds in operation mode.  <i>Note: When options 1, 2, or 3 are selected, the expected battery life will be reduced.</i></p> <p>Values:            0 = disabled            1 = enabled for audible chirp            2 = enabled for blue LED flash            3 = enabled for audible chirp and blue LED flash</p> <p>Increments the value.</p> <p>One press saves the displayed value and activates the next configuration-mode screen.</p>
 <p>Operation-mode bump test</p>	<p>This display screen features the status, lock, configuration, and bump test icons, with the selection number in the main area. The technician can enable or disable this operation mode feature.</p> <p>When enabled, the instrument operator is given access to bump test the unit from operation mode.</p> <p>Values:            0 = disabled            1 = enabled</p> <p>Increments the value.</p> <p>One press saves the displayed value and activates the next configuration-mode screen.</p>

Table 4.1 Configuration instruction



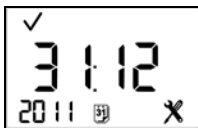

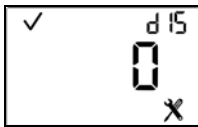

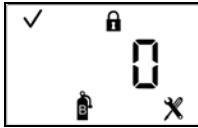





Setting Button	Description Button effect
 <p>Bump test due warning</p>	<p>This display screen features the status, alarm, configuration, warning, and bump test icons. The technician can disable or enable the warning, and choose the warning type.</p> <p>When enabled, the unit will notify the user that the bump test is due, based on the selected option. The instrument will continue to operate.</p> <p><i>Note: When options 1, 2, or 3 are selected, the expected battery life will be reduced.</i></p> <p>Values:            0 = disabled            1 = enabled for audible chirp            2 = enabled for blue LED flash            3 = enabled for combination audible chirp and blue LED flash            4 = enabled for display only</p> <p> Increments the value.</p> <p> One press saves the displayed value and activates the next configuration-mode screen.</p>
 <p>Bump test interval</p>	<p>This display screen features the status, configuration, calendar and, bump test icons, with the interval setting in the main area. The technician can set the interval at which the bump test due warning is to be activated.</p> <p>Value range: 0.5 to 30.0 days            Value increment: 0.5 days</p> <p> The first press activates the value. Continued presses increment the value; hold to speed the increment pace.</p> <p> One press saves the displayed value; a second press activates the next configuration-mode screen.</p>
 <p>Bump test percentage</p>	<p>This display screen features the status, configuration, and bump test icons, with the current setting in the main area. The technician can set the percentage of calibration gas to which the unit will respond.</p> <p>Value range: 50% to 95%            Value increment: 1%</p> <p>See Table 1.5 for sensor information that can aid in the setting of bump test values.</p> <p> The first press activates the value. Continued presses increment the value; hold to speed the increment pace.</p> <p> One press saves the displayed value; a second press activates the next configuration-mode screen.</p>
 <p>Bump test response-time</p>	<p>This display screen features the status, clock, configuration, and bump test icons, with the current setting in seconds in the main area. A sensor passes a bump test when it senses the specified percentage of calibration gas within the specified response time setting.</p> <p>Value range: 30 to 120 seconds            Value increment: 1 second</p> <p> The first press activates the value. Continued presses increment the value; hold to speed the increment pace.</p> <p> One press saves the displayed value; a second press activates the next configuration-mode screen.</p>

Table 4.1 Configuration instruction

Setting Button	Description Button effect
 <p>Alarm latch</p>	<p>This display screen features the status, alarm, lock, and configuration icons, with the current setting in the main area. The technician can enable or disable this operation-mode feature.</p> <p>When <i>disabled</i>, a unit in alarm will turn off its alarm when the gas reading is no longer at the alarm-producing concentration.</p> <p>When <i>enabled</i>, a unit in alarm will remain in alarm until it is manually reset. The instrument operator can reset a latched alarm from operation mode with a long press of the enter button (↵). This resets the alarm; it does <i>not</i> disable an enabled latch.</p> <p>Values: 0 = disabled 1 = enabled</p> <p>↵ Increments the value.</p> <p>⏻ One press saves the displayed value and activates the next configuration-mode screen.</p>
 <p>Vibration alarm</p>	<p>This display screen features the status, alarm, "Vlb", and configuration icons, with the selection number in the main area. When enabled, the vibrating alarm will be activated when the unit is in alarm.</p> <p>Values: 0 = disabled 1 = enabled</p> <p>↵ Increments the value.</p> <p>⏻ One press saves the displayed value and activates the next configuration-mode screen.</p>
 <p>Operation-mode zero</p>	<p>This display screen features the status, lock, zero, and configuration icons. The technician can enable or disable this operation-mode option.</p> <p>When enabled, the instrument operator is given access to zero the unit from operation mode.</p> <p>Values: 0 = disabled 1 = enabled</p> <p>↵ Increments the value.</p> <p>⏻ One press saves the displayed value and activates the next configuration-mode screen.</p>
 <p>Operation-mode calibration</p>	<p>This display screen features the status, lock, configuration, and calibration icons. The technician can enable or disable this operation-mode option.</p> <p>When enabled, the instrument operator is given access to calibrate the unit from operation mode.</p> <p>Values: 0 = disabled 1 = enabled</p> <p>↵ Increments the value.</p> <p>⏻ One press saves the displayed value and activates the next configuration-mode screen.</p>

Table 4.1 Configuration instruction







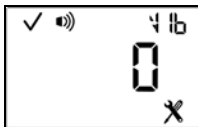
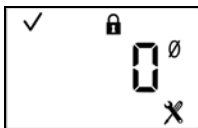
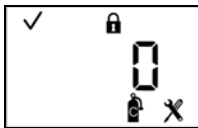

Setting Button	Description Button effect
 <p>Calibration due warning</p>	<p>This display screen features the status, alarm, configuration, calibration, and warning icons. The technician can disable or enable the warning, and choose the warning type. When <i>enabled</i>, the unit will notify the user that calibration is due, based on the selected option. The instrument will continue to operate.</p> <p><i>Note: When options 1, 2, or 3 are selected, the expected battery life will be reduced.</i></p> <p>Values:            0 = disabled            1 = enabled for audible chirp            2 = enabled for blue LED flash            3 = enabled for combination audible chirp and blue LED flash            4 = enabled for display only</p>
	<p>Increments the value.</p>
	<p>One press saves the displayed value and activates the next configuration-mode screen.</p>
 <p>Calibration interval</p>	<p>This display screen features the status, configuration, calibration, and calendar icons, with the current setting in the main area. The technician can set the interval at which the calibration due warning is to be activated.</p> <p>Value range: 1 to 365 days            Value increment: 1 day</p>
	<p>The first press activates the value. Continued presses increment the value; hold to speed the increment pace.</p>
	<p>One press saves the displayed value; a second press activates the next configuration-mode screen.</p>
 <p>Calibration date</p>	<p>This display screen features the status, up and down arrow, configuration, calibration, warning, and calendar icons. The technician can choose whether the operation-mode calibration date screen will display the due date for the unit's <i>next</i> calibration or the date of the unit's <i>last</i> calibration.</p> <p>The up arrow (▲) will be featured on-screen when the unit is set to display the <i>next</i> the calibration due. The down arrow (▼) will be featured when the unit is set to display the <i>last</i> calibration date.</p> <p>Values:            0 = displays date of last calibration            1 = displays next calibration due date</p>
	<p>Increments the value.</p>
	<p>One press saves the displayed value and activates the next configuration-mode screen.</p>

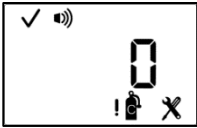
Table 4.1 Configuration instruction





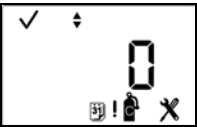







Setting Button	Description Button effect
 <p>Dock due warning</p>	<p>This display screen features the status, alarm, configuration, warning, and “dOC”, icons, with the selection number in the main area. The technician can disable, or enable the warning, and choose the warning type.</p> <p>When enabled, the unit will notify the user that docking to a station is due, based on the selected option. The instrument will continue to operate.</p> <p><i>Note: When options 1, 2, or 3 are selected, the expected battery life will be reduced.</i></p> <p>Values:</p> <p>0 = disabled            1 = enabled for audible chirp            2 = enabled for blue LED flash            3 = enabled for combination audible chirp and blue LED flash            4 = enabled for display only</p>
	<p>Increments the value.</p>
	<p>One press saves the displayed value and activates the next configuration-mode screen.</p>
 <p>Dock due (Sync) interval</p>	<p>This display screen features the status, configuration, calendar, and “SYnC” icons, with the current value in the main area. The technician can set the interval at which the dock due warning is to be activated.</p> <p><i>Note: When there is a high or low alarm, the unit will display the dock due icons automatically.</i></p> <p>Value range: 1 to 365 days            Value increment: 1 day</p>
	<p>The first press activates the value. Continued presses increment the value; hold to speed the increment pace.</p>
	<p>One press saves the displayed value and activates the next configuration-mode screen.</p>
 <p>Maintenance interval</p>	<p>This display screen features the status, clock, configuration and warning icons, with “min” in the lower left area, and the time interval setting in the main area. The technician can choose the signal frequency for all enabled calibration, bump test, and dock due notifications.</p> <p>For example, if the technician sets the interval for five minutes, every five minutes the indicator selected from the enabled maintenance due warnings (calibration, bump test, and dock due) will be activated.</p> <p>Value range: 1 to 60 minutes            Value increment: 1 minute</p>
	<p>The first press activates the value. Continued presses increment the value; hold to speed the increment pace.</p>
	<p>One press saves the displayed value and activates the next configuration-mode screen.</p>
 <p>Security code</p>	<p>This display screen features the status, lock, and configuration icons, with the current security code in the main area. The security code controls two things: access to a unit's configuration mode and the ability to power off a unit that is configured for always-on operation.</p> <p>If the security code is set at 000, entry to configuration mode is <i>not</i> security-code protected, and an always-on unit can be powered off without a security code. Any other value will enable the security code.</p> <p>Value range: 000 to 999            Value increment: 1</p>
	<p>The first press activates the value. Continued presses increment the value; hold to speed the increment pace.</p>
	<p>One press saves the displayed value; a second press activates the next configuration-mode</p>

Table 4.1 Configuration instruction

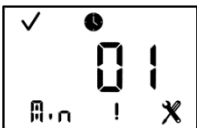











Setting Button	Description Button effect
	screen.
 <p>Country-of-origin</p>	<p>This display screen features the status, "CO n" (country-of-origin), and configuration icons, with the current setting. This feature sets automatically the low- and high-gas alarm setpoints. The technician must choose one of these options:</p> <p>"DEF" = USA and default value            "CAN" = Canada            "EUR" = Europe            "CR" = Czech Republic            "AUS" = Australia</p> <p>The unit's settings are immediately updated to reflect that country's (or Europe's) low- and high-gas alarm setpoints for the installed sensor-type. When the country-of-origin selection does not contain a value for an alarm setpoint, the default value (DEF) is automatically substituted.</p> <p> The first press activates the value. Continued presses increment the value; hold to speed the increment pace.</p> <p> One press saves the displayed value and activates the next configuration-mode screen.</p> <p><i>Notes: Each alarm setting can be edited individually, in configuration mode, at that alarm's setpoint screen. Because low- and high-gas alarm setpoints can be edited both individually and through the country-of-origin option, it is important to understand override behavior.</i></p> <p><i>Example.</i> The H<sub>2</sub>S low-gas alarm setpoint was edited – at its setpoint screen – to a value of 9 ppm. Afterwards, a country-of-origin selection was made where the H<sub>2</sub>S low-gas alarm setpoint value is 10 ppm. The last-entered setting overrides the first. Therefore, in this example, the value of the H<sub>2</sub>S low gas alarm setpoint is 10 ppm.</p> <p>Another aspect to alarm settings applies to replacement or new sensors. For example:</p> <ul style="list-style-type: none"> <li>• If the installed H<sub>2</sub>S sensor(s) is replaced with other H<sub>2</sub>S sensor(s), the last-entered low-gas alarm setpoint (a value of 10 ppm in the above example) will be applied to the newly installed sensor(s).</li> <li>• If the installed H<sub>2</sub>S sensors are replaced with a different sensor type (e.g., CO), the alarm settings will be read from the newly installed sensor(s).</li> </ul>
 <p>Language</p>	<p>This display screen features the status, "LAN" (language), and configuration icons, with the current setting. The technician can choose from these options:</p> <p>"En" = English            "F" = French</p> <p> Increments the value.</p> <p> One press saves the displayed value and activates the next configuration-mode screen.</p>
 <p>Always-on</p>	<p>This display screen features the status, lock, configuration, and the battery icon. The technician can enable or disable this feature. When enabled, the entry of the unit's security code (if the security code is <i>not</i> 000) will be required to complete the shutdown process.</p> <p>Values:            0 = disabled            1 = enabled</p> <p> Increments the value.</p> <p> One press saves the displayed value and activates the next configuration-mode screen.</p>

Table 4.1 Configuration instruction

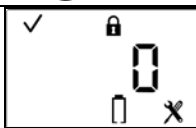

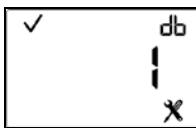

Setting Button	Description Button effect
 Shutdown in alarm	<p>This display screen features the status, alarm, lock, "OFF", configuration, and battery icons, with the selection number in the main area. The technician can allow or disallow the operator to shut down the unit during an alarm.</p> <p>Values:            0 = disallows shutdown            1 = allows shutdown</p> <p>Increments the value.</p> <p>One press saves the displayed value and activates the next configuration-mode screen.</p>
 Dead-band value	<p>This display screen features the status, "db", and configuration icons, with the selection number in the main area. The technician can set the instrument to display one of two values for gas readings that are within a sensor's dead-band range, the value of the reading or a value of zero.</p> <p>Values:            0 = display a value of zero            1 = display reading value</p> <p>Increments the value.</p> <p>One press saves the displayed value and activates the next configuration-mode screen.</p>
 Alarms when docked	<p>This display screen features the status, alarm, lock, configuration, and "dOC" icons, with the current setting in the main area. The technician can enable or disable this setting.</p> <p>Values:            0 = disable alarms when docked            1 = enable alarms when docked</p> <p>Increments the value.</p> <p>One press saves the displayed value and activates the next configuration-mode screen.</p>
 Enable gas-alert	<p>This display screen features the status, alarm, lock, configuration, and "gAS" icons, with the current setting in the main area. The technician can enable or disable the gas-alert feature. When enabled, the unit will notify the user when a detected gas concentration may be approaching alarm levels.</p> <p>Values:            0 = disable gas-alert            1 = enable gas-alert</p> <p>Increments the value.</p> <p>One press saves the displayed value and activates the next configuration-mode screen.</p>

After the configuration process is completed and before the unit's first use, calibrate the instrument (see "Zero, Calibration, and Bump Test").

## Operation

In operation mode, the following apply:

- ✓ With successive short presses of the on-off-mode button (⏻), the instrument operator can scroll through the operation-mode loop.

- ✓ The zero, calibration, and bump test processes can be completed only if these task settings are enabled for operation-mode access.
- ✓ The TWA, STEL (if enabled for operation-mode access), and peak readings can be viewed and cleared. When any summary reading is cleared, its value is reset to zero and its time-related setting is also reset to zero.
- ✓ In general, the buttons are used as follows:
  - Press  to scroll through the operation-mode loop.
  - Press  to initiate a task or to clear a reading.
  - A long press on  will reset a latched alarm; it does *not* disable an enabled latch.
  - When  and  are simultaneously pressed and held for three seconds, the unit will complete a self-test.
  - Except where noted, when no button is pressed for 30 seconds, the gas-monitoring screen is activated.

The operation-mode loop is outlined below (see Table 4.2). Instructions for button use accompany each display screen.

Table 4.2 Operation instruction











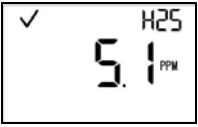







Screen	Screen description
Buttons	Button effects
 <p>Gas monitoring</p>	<p>This display screen (numeric shown) features the check mark and sensor-type icons, and the current gas reading and unit of measure. The check mark indicates the unit is operational and there are no sensor faults.</p>
	<p>One short press turns on the backlight if the unit senses it is not in a well-lit environment. When the unit is in alarm, a long press will reset a latched alarm; the alarm will recur if the alarm-causing condition is still present.</p>
	<p>Activates the next enabled operation-mode screen.</p>
 <p>Calibration date</p>	<p>This display screen features the calibration, calendar, and check mark icons, an up or down arrow, and a date value. When the up arrow () is featured, the <i>next</i> calibration date is displayed. When the down arrow () is featured, the <i>last</i> calibration date is displayed. Values: Date: XX (day) and XX (month) Year: XXXX</p>
	<p>No effect.</p>
	<p>Activates the next enabled operation-mode screen.</p>

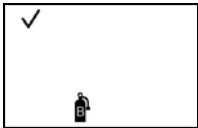

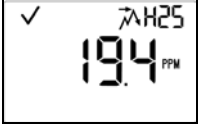
Table 4.2 Operation instruction

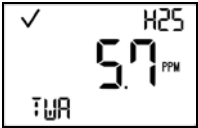
Screen Buttons	Screen description Button effects
 <p>Initiate zero</p>	<p>This display screen is activated if the unit is enabled for operation-mode zeroing. It features the check mark and zero icons.</p> <p> Starts the zero process (see "Zero, Calibration, and Bump Testing").</p> <p> Activates the next enabled operation-mode screen.</p>
 <p>Initiate bump test</p>	<p>This display screen is activated if the unit is enabled for operation-mode bump testing. The screen features the check mark and bump test icons.</p> <p> Starts the bump test process (see "Zero, Calibration, and Bump Testing").</p> <p> Activates the next enabled operation-mode screen.</p>
 <p>Peak reading</p>	<p>This display screen features the check mark, peak, and sensor-type icons, and the most recent peak reading.</p> <p> Clears the peak reading.</p> <p> Activates the next enabled operation-mode screen.</p>
 <p>TWA reading</p>	<p>This display screen is activated if this feature is operation-mode enabled. The screen features the check mark, sensor-type, and TWA icons, and the current TWA reading.</p> <p> Clears the TWA reading.</p> <p> Activates the next enabled operation-mode screen.</p>
 <p>STEL reading</p>	<p>This display screen is activated if this feature is operation-mode enabled. The screen features the check mark, sensor-type, and STEL icons, and the current STEL reading.</p> <p> Clears the STEL reading.</p> <p> Activates the next enabled operation-mode screen.</p>

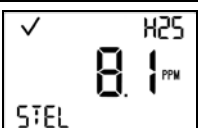
# Zero, Calibration, and Bump Test

Perform the zero, calibration, and bump testing tasks in an area known to be nonhazardous.

Table 4.3 Zero, calibration, and bump test

## Supplies

Calibration cup (shipped with the unit)

Calibration tubing (shipped with the unit)

Calibration gas cylinder suitable for the installed sensors and the unit's calibration gas settings

Positive flow regulator suitable for the calibration gas cylinder

## Preparation



Holding the regulator, turn the calibration gas cylinder in a clockwise direction to tighten.



Connect either end of the calibration tubing to the regulator's nipple.



Connect the other end of the tubing to the calibration cup. Proceed with the instruction set below for the desired task: calibration or bump testing.

## Instruction

### Zero



Initiate zero

*Note:* From anywhere in the operation-mode loop, press until the initiate-zero screen is activated.

At the initiate-zero screen, press to start the zero process.



Zero in-progress

While the sensors are zeroed, the zero-in-progress screen is activated.

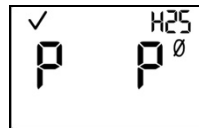

Zero results (pass)

After the sensors are zeroed, the zero-results screen is activated and an audible alert is emitted.

If the result for *either* sensor is an "F" for fail, press to reactivate the initiate-zero screen. Repeat the zero process. If the result for *both* sensors is a "P" for pass, press then to display the initiate-calibration screen. If calibration is *not* desired, wait approximately 30 seconds for the zero-results screen to deactivate; the gas-monitoring screen will be automatically activated.

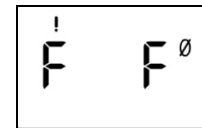

Zero results (fail)

**Table 4.3 Zero, calibration, and bump test**

*Calibration*



Place the calibration cup over the case top; align its top groove with the small ridge at the top of the instrument.  
 Press down to secure the cup in place; a click will sound.  
 Visually inspect the calibration cup to ensure its edges along the top and sides align with the case top edges.

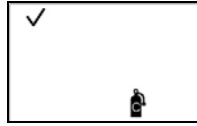

Initiate calibration



Calibration apply gas

To start the calibration process, press . Both sensors will be calibrated simultaneously.  
 To cancel the calibration, press .

Once the calibration is started, the apply-gas screen is activated; the expected type and concentration of calibration gas are displayed. This screen remains activated for up to 5 minutes as the unit awaits the application of calibration gas. To cancel the calibration, press .



Calibration in progress

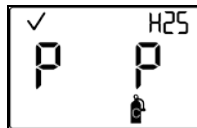

Calibration results (pass)

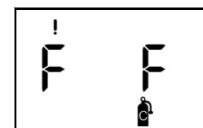

Calibration results (fail)

To start the flow of gas, turn the regulator knob in a counterclockwise direction.  
 While the sensors are calibrated, the calibration-in-progress screen displays the span reserve value.  
 If desired, press to cancel the calibration.

If at least one sensor passes calibration, two results screens are alternately activated; one indicates the pass or fail result for each sensor and the other displays the span reserve value. If neither sensor passes calibration, the audible, visual, and vibrating alarms turn on. Two results screens are alternately activated; one indicates the fail results and the other displays the span reserve value.

*Note:* With two installed, working sensors, the span reserve value is the algorithm calculation of the DualSense Technology.

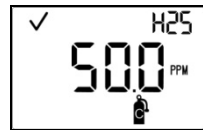

Span reserve value



To stop the flow of gas, turn the regulator knob in a clockwise direction and tighten.



To remove the calibration cup, lift up from the cup's tabs. Set aside or store for future use.

If at least one sensor passes the calibration, the gas-monitoring screen will be automatically activated.  
*Note:* The span reserve value divided by the calibration gas concentration yields the span reserve percentage. A span reserve percentage of greater than 70% indicates a "good" sensor; 50%-70% indicates "marginal" sensitivity. When the span reserve percentage is less than 50%, the sensor will not pass calibration.

**Table 4.3 Zero, calibration, and bump test**

*Bump testing*



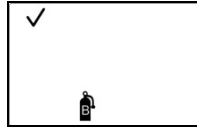

Place the calibration cup over the case top; align its top groove with the small ridge at the top of the instrument. Press down to secure the cup in place; a click will sound. Visually inspect the calibration cup to ensure its edges along the top and sides align with the case top edges.



Initiate bump test



Bump test apply gas

*Note:* From anywhere in the operation-mode loop, press  until the initiate-bump-test screen is activated. Press  to start the bump test process. Press  to cancel the bump test.

Once the bump test is started, the apply-gas screen is activated; the expected type and concentration of calibration gas are displayed. This screen remains activated for up to 5 minutes as the unit awaits the application of calibration gas.



To start the flow of gas, turn the regulator knob in a counterclockwise direction.



Bump test in progress

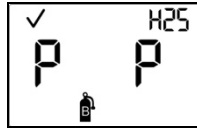

Bump test results (pass)

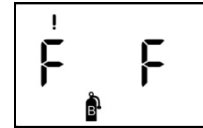

Bump test results (fail)

If either or both sensors fail the bump test, the calibration due warning screen will be automatically activated. Calibrate the instrument.

If both sensors pass the bump test, the gas-monitoring screen will be automatically activated.



To stop the flow of gas, turn the regulator knob in a clockwise direction and tighten.



To remove the calibration cup, lift up from the cup's tabs. Set aside or store for future use.

---

# Alarms, Warnings, and Notifications

Overview

Alarms

Warnings and Failures

---

## Overview

This chapter provides in-depth information about alarms, warnings, and notifications; portions of this text appear in abbreviated form elsewhere within this product manual.

Alarms notify the instrument operator of danger.

Warnings notify of a condition that needs attention.

Indicators notify of a status (e.g., confidence indicator).

Take seriously all alarms, warnings, and indicators, and respond to each according to company policy.

## Alarms

The Tango TX1 instruments have alarms of two different intensities, high and low. Alarms are persistent: they turn off when the alarm-causing event is no longer detected; however, if the instrument's *alarm latch* is enabled, an alarm will remain on until the user presses  to turn it off.

When all alarm signals\* are on:

- The *high alarm* features the red lights, with steady sound. It is fast-paced.
- The *low alarm* is similar to the high alarm, but includes blue, as well as red light. It is medium-paced.

\*Signals (visual, audible, and vibration) vary based on instrument settings.

Once the detected gas concentration changes, the alarm indicators will change to reflect any new condition such as low-alarm gas, high-alarm gas, over-range gas, or no gas alarm. Different events can produce the same alarm. Events are distinguished from one another through the use of symbols that appear on the instrument display screen (see Table 5.1).

**Table 5.1 Alarm Events (listed)**

**Alarm Level : High**

Gas Present (H<sub>2</sub>S is shown.)



Gas present, over-range alarm

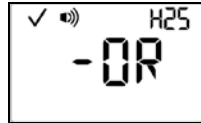

Gas present, negative over-range alarm



Gas present, high alarm



STEL alarm

**Nongas high alarms**

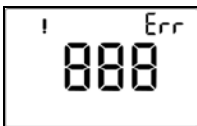

System alarm

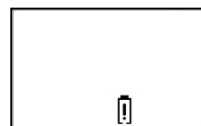

Critical low-battery alarm (occurs after ten minutes of low-battery warning)

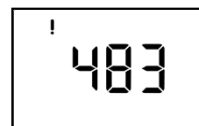

Sensor error alarm (both sensors)

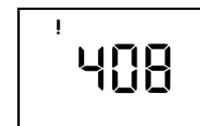

No sensor installed

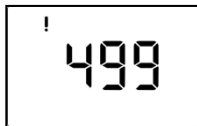

Two sensor "types" installed

Note: Error code 406 is an illegal sensor position, the instrument does not accept the installed sensor type.

**Alarm Level : Low**

Gas Present



Gas present, low alarm

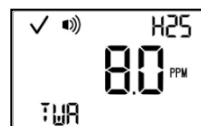

TWA alarm

## Warnings and failures

Warnings turn on and off repeatedly. The more urgent the warning, the shorter the time between on-off occurrences: a warning that repeats every two seconds is more urgent than a warning that repeats every thirty seconds.

Warnings persist until the event is resolved. In some cases, an unresolved warning will become more urgent in frequency. For example, a low-battery warning that is not resolved will change to alarm status indicating a critical low-battery condition.

As with alarm events, warning events are distinguished from one another on the instrument display screen using different symbols. Table 5.2 lists the symbols used for different warning events.

**Table 5.2 Warning (listed)**

Symbol	Warning event	Description
	Calibration due*	The instrument requires calibration.
	Bump test due*	The instrument requires a bump test.
	Dock due*	The instrument requires docking.
	Acknowledgeable Gas-alert *	A detected gas concentration may be approaching alarm levels. To turn off the warning signals, press and hold
	Single sensor data failure	Sensor 1 or Sensor 2 is not installed, or is in data failure.
	Critical Error	A critical error has occurred; a three digit number code will be displayed.
	Low-battery	The instrument's battery is low.

\*Signals (visual, audible, and vibration) vary based on instrument settings.

**Table 5.3 Warning and Failure Screens**

**Warnings**

Calibration due*	Bump test due*	Dock Due*	Gas-alert (If enabled)
		—	—
Low-battery warning**	One sensor Installed		

**Failures**

Single sensor calibration failure	Single sensor bump failure with calibration overdue	Single sensor zero failure	Single sensor data failure

\*Signals (visual, audible, and vibration) vary based on instrument settings.

\*\* Occurs for ten minutes before critical low-battery alarm.

Note: For additional assistance in resolving any alert, warning, or alarm, see a supervisor or contact Industrial Scientific (see "Contact Information").





---

# Service and Warranty

Service Instructions

Supplies

Three-dimensional Diagrams

Service Tasks

Warranty Policy

Limitation of Liability

---

## Service Instructions

Perform all service tasks on a nonconductive surface in a well-lit area that is known to be nonhazardous.

Wear grounding straps to prevent electrostatic discharge (ESD) which can cause damage to the unit's electronics.

When working with the adhesive-backed filters and gaskets:

- ✓ Be careful not to pierce or tear these items.
- ✓ When using tweezers, apply gentle pressure.
- ✓ Once the adhesive touches a surface, any attempt to remove or reposition the item may cause it damage.

When working with sensors and the case top's water barriers:

- ✓ Do not touch the white membranes as this can contaminate these items.
- ✓ Use care not to damage the membranes.
- ✓ Use care not to separate the sensor from its membrane.

### SUPPLIES

Torx screwdriver (for case bottom and clip screws)

Needle-nose tweezers (for barrier and filter service tasks)

## THREE-DIMENSIONAL DIAGRAMS

Refer to the three-dimensional diagrams for disassembled views of the instrument and its case top assembly. Use the diagram number to identify parts, part numbers, and field-replaceable items (see Table 6.1).

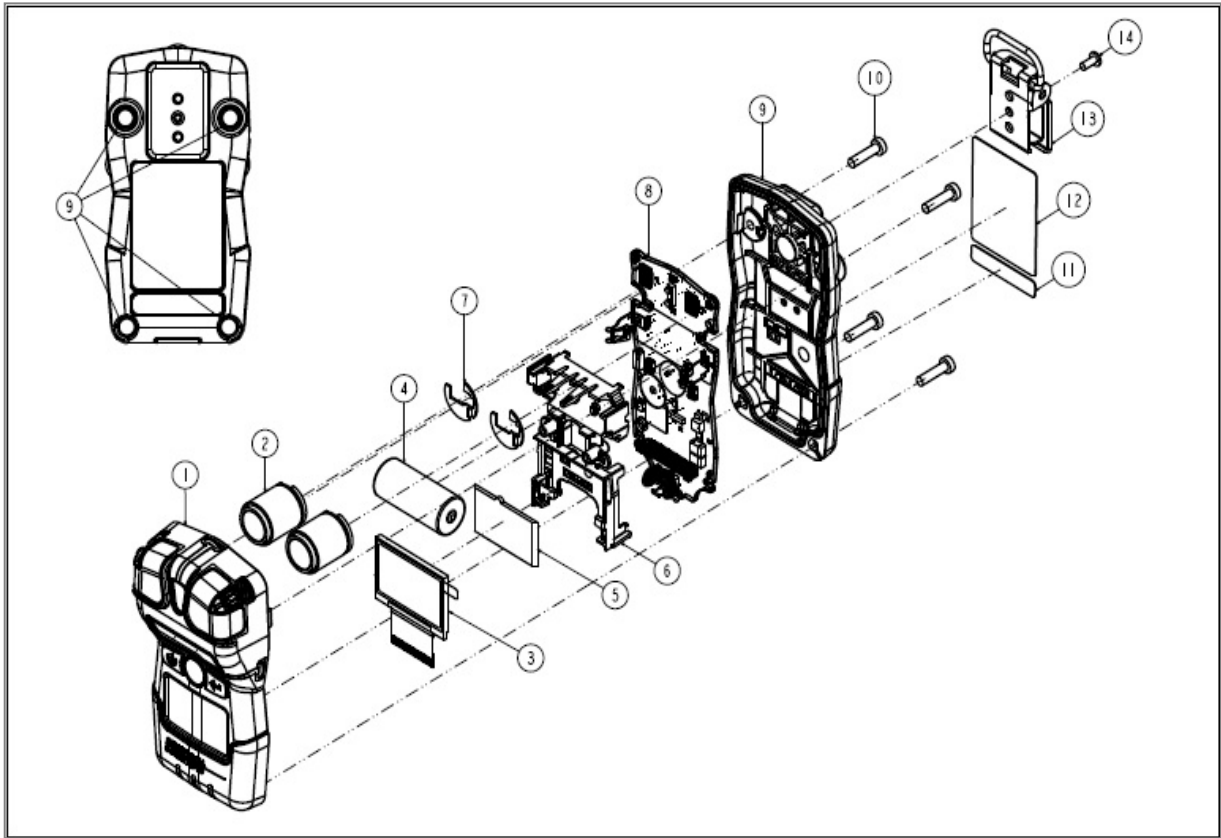

Figure 6.1 Disassembled Tango TX1

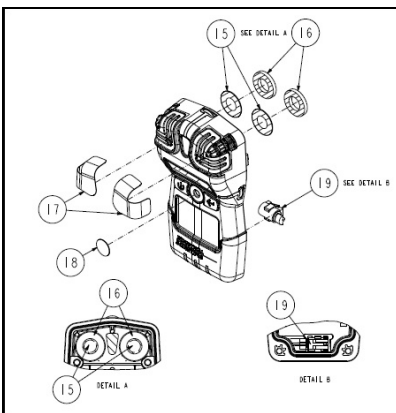

Figure 6.2 Disassembled Tango TX1 case top assembly

**Table 6.1 Key for the Tango TX1 diagram**

Diagram number	Part name	Field replaceable	Part number	Notes
--	Case top assembly The case top can be replaced as a single assembly that includes the parts labeled with diagram numbers: 1, 14, 15, 16, and 17. These components are also sold separately.	Yes	17153951	Assembly includes case top (17153952); sensor water barriers and gaskets (17154219 and 17154051, respectively); and sensor and audible alarm dust barriers (17154540 and 17154581, respectively).
1	Case top	Yes	17153952	
15	Sensor water barrier	Yes	17154219	Parts 17154219 and 17154051 should be replaced at the same time. Kit 18109230 contains 10 barriers and 10 gaskets.
16	Sensor water barrier gasket	Yes	17154051	
17	Sensor dust barrier	Yes	17154540	Kit 18109218 contains 10 sensor dust barriers and 5 audible alarm dust barriers. <i>Notes:</i> The dust barriers are <i>not</i> water impenetrable. More frequent replacement service may be needed in harsh environments.
18	Audible alarm dust barrier	Yes	17154581	
19	Vibration alarm motor	Yes	17127275	
2	Sensors	Yes	Varies	
	CO	Yes	17155161	Includes two sensors and polycarbonate plates.
	H2S	Yes	17155164	Includes two sensors and polycarbonate plates.
	NO2	Yes	17155162	Includes two sensors and polycarbonate plates.
	SO2	Yes	17155163	Includes two sensors and polycarbonate plates.
	CO / H2 Low	Yes	17155823	Includes two sensors and polycarbonate plates.
4	Battery	Yes	17154367	
3 and 5	LCD	No*	17153786	
7	Polycarbonate plate (not sold separately)	Yes	—	See "Sensors" above.
6 and 8	Board assembly	No*	—	
11 and 12	Unit labels	No*	—	
13	Garment clip	Yes	17154484	
not shown	Belt clip (optional)	Yes	17120908	
not shown	Audio alarm amplifier (optional)	Yes	17154915	
14	Screw (for use with installed garment clip and optional belt clip)	Yes	17139262	Torque: 81 newton cm (115 ounce-force inch)
10	Case bottom screws	Yes	17154328	Torque: 85 newton cm (120 ounce-force inch)
9	Case bottom	No*	17153769	

\*For items that are not field-replaceable, contact ISC (see "Contact Information") or a local distributor of ISC products.

## SERVICE TASKS

Table 6.2 Service tasks

 Power off the unit before disassembling or performing any service task.

### Instrument disassembly



Using a torx screwdriver, remove all four screws from the case bottom; set aside the screws.



Hold the case bottom near the upper screw holes; lift the case top slightly to separate the top and bottom.



Continue to lift the case top straight up to remove it and to avoid unintentionally loosening the sensors. If replacing just the case top, refer to the task below, "Instrument assembly". Otherwise, proceed with the desired service tasks below.

### Sensor port and audible alarm dust barrier replacement (sensor port dust barrier shown)



Using a finger or needle-nose tweezers, peel off the dust barrier and discard.

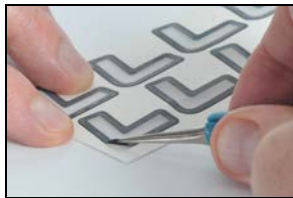

Place the barrier packet on the work surface. Scrape lightly across the paper to the barrier's edge; gently lift to expose a portion of its adhesive back. Peel the barrier from the packet.



Guide the new barrier—adhesive side down—onto the case top. Using a finger, press and hold for five seconds to activate the adhesive.



### Sensor water barrier assembly replacement

*Note.* The sensor water-barrier assembly consists of two parts: the filter and its gasket. Replace both items at the same time.



Inside the case top, grip the gasket and underlying sensor filter with the needle-nose tweezers; peel to remove.



Remove any remnants of the adhesive, filter, or gasket. Clear away any dirt, dust, or debris.



Place the filter packet on the work surface. Using the tweezers, scrape lightly across the paper to the filter's edge; gently lift to expose a portion of the adhesive back.



Grip the filter lightly with the tweezers; peel the filter from the packet.

Table 6.2 Service tasks



Guide the new filter— adhesive side down—into the filter opening.  
For proper placement, take care to ensure the filter edge meets the inner edge of the filter opening.



Using a clean, soft cloth, press gently around the filter edge; hold for five seconds to activate the adhesive.



Place the gasket packet on the work surface.  
Using the tweezers, scrape lightly across the paper to the gasket ring's edge; gently lift to expose a portion of the adhesive back.



Grip the gasket ring lightly with the tweezers; peel the gasket ring from the packet.



Guide the gasket—adhesive side down—into the filter opening, placing it on top of the filter.  
Ensure the gasket ring edge meets the outer edge of the filter opening and fully covers the white filter membrane.



Using a clean, soft cloth, press gently around the gasket edge; hold for five seconds to activate the adhesive.

### Vibrating alarm motor replacement



Insert the tweezers between the case top and the motor.  
Pry up to remove.



Using the tweezers, gently grip the new motor.  
Place the new motor – contact side up – into the case top.  
Without touching the motor's contacts, use the tweezers handle to press the item into place.



### Sensor replacement



Lift the sensor to remove it.  
Some sensors may have an adhesive backing holding them in place; use gentle pressure to lift and remove the sensors.  
Set aside for future use or dispose of according to company policy.

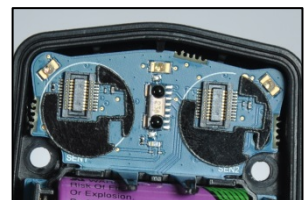
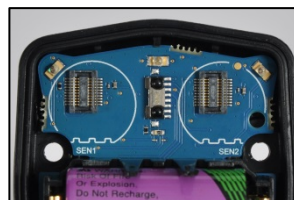

Examine the circuit board for the presence of a black polycarbonate plate in each sensor position.  
As shown above (left) neither sensor position has the polycarbonate plate.  
If both sensor positions are equipped with the plates as shown above (right), skip to the sensor placement steps below.



The plates are adhered to a paper backing. Bend the paper backing to separate the plate.

Lightly grip the plate near its top with tweezers; gently lift to completely remove from paper backing.

Guide the plate – adhesive side down – for correct placement on the circuit board as shown above (right). Take care to ensure the plate edge aligns with the sensor outline on the board.

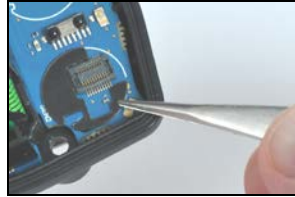

Using a clean, soft cloth, press gently into place.

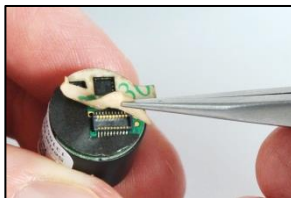

For each sensor, use tweezers to remove the paper liner from the bottom of the sensor and expose the adhesive backing.

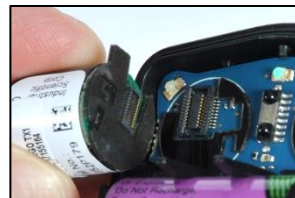

Position the sensor to align with its connector on the instrument board.

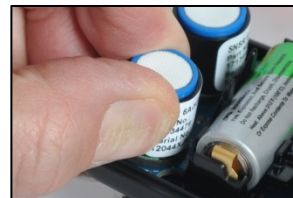

Secure the sensor in place by applying gentle pressure to the sides of the sensor case. Do not touch the sensor's white membrane.

A slight connection impact can be felt when the sensor is secured into place.

*Note: Replace DualSense sensors as a pair.*

### Battery replacement



Lift the battery up from its cradle.

Dispose of according to company policy.



The instrument's interior power button is located below the battery cradle and to the left of the speaker (see arrow above).

Press and hold this button for two seconds, then release it.



Orient the replacement battery so the positive and negative ends align with the "+" and "-" cradle markings, respectively. Place the new battery into the cradle negative end first.

Press down on the battery to secure it in the cradle.

*Note:* Once started, if the battery replacement task is *not* completed within 60 minutes, the following will occur:

- Any data will be lost that was not downloaded prior to the start of the task.
- The unit's time and date settings will be erased. When these settings are erased, the user will be prompted, during the next start-up sequence, to enter the correct time and date.

*Note:* It is essential—for data log accuracy—that these tasks be completed. The data log plays an important role in preserving operator safety, and in the investigation of any potential incident, it can be useful to the safety team or a prospective investigator.



---

### Clip removal and attachment (garment clip shown)



Lift the clip's cover.



Use a torx screwdriver to access the clip's screw. Turn counterclockwise to loosen and remove the screw and washer.



Lift the clip to remove it. Close the clip; store it for future use.



To attach the clip cover, place the screw through the center hole of the clip back.



Guide the screwdriver through the clip's hole and into the screw head. Turn clockwise to tighten.

*Note:* Refer to Table 6.1 for torque values.

---

### Instrument assembly



Hold the case bottom near the upper screw holes.



Lower the case top assembly onto the case bottom. Use a straight-down motion to guide the sensors into the sensor barrels.



Press to secure the case top and case bottom.



Using a torx screwdriver, insert and tighten each of the four screws into the case bottom.

*Note:* Refer to Table 6.1 for torque values.

# Warranty Policy

Industrial Scientific Corporation's portable Tango TX1 gas-monitoring instrument is Guaranteed for Life™. Warranted to be free from defects in material and workmanship, under normal and proper use and service for as long as the instrument is supported by Industrial Scientific Corporation.

The above warranty does not include the sensors, battery, or filters, but the sensors carry their own separate warranty. The factory-installed sensors are warranted to be free from defects in material and workmanship under normal and proper use and service as follows, except where otherwise stated in writing in Industrial Scientific literature accompanying the product:

- CO and H2S sensors are warranted for three years from the initial purchase date.
- All other sensors are warranted for two years from the initial purchase date.

## LIMITATION OF LIABILITY

**THE WARRANTY SET FORTH ABOVE IS STRICTLY LIMITED TO ITS TERMS AND IS IN LIEU OF ALL OTHER WARRANTIES, GUARANTEES, EXPRESS OR IMPLIED, ARISING BY OPERATION OF LAW, COURSE OF DEALING, USAGE OF TRADE OR OTHERWISE. INDUSTRIAL SCIENTIFIC MAKES NO OTHER WARRANTIES, EITHER EXPRESSED OR IMPLIED, INCLUDING BUT NOT LIMITED TO THE WARRANTIES OF MERCHANTABILITY OR FITNESS FOR PARTICULAR PURPOSE.**

Should the product fail to conform to the above warranty, buyer's only remedy and Industrial Scientific's only obligation shall be, at Industrial Scientific's sole option, replacement or repair of such non-conforming goods or refund of the original purchase price of the non-conforming goods.

In no event will Industrial Scientific be liable for any other SPECIAL, INCIDENTAL OR CONSEQUENTIAL OR OTHER SIMILAR DAMAGES, including loss of profit or loss of use, arising out of the sale, manufacture or use of any products sold hereunder whether such claim is pleaded in contract or in tort, including strict liability in tort and whether Industrial Scientific has been advised of the potential for such damages.

Industrial Scientific's total liability hereunder from any cause whatsoever (except liability from personal injury caused by Industrial Scientific's negligence), whether arising under contract, warranty, tort (including negligence), strict liability, products liability or any other theory of liability, will be limited to the lesser of Buyer's actual damages or the price paid to Industrial Scientific for the Products that are the subject of Buyer's claim. All claims against Industrial Scientific must be brought within one year after the cause of action arises, and Buyer expressly waives any longer statute of limitations.

It shall be an express condition to Industrial Scientific's warranty that all products be carefully inspected for damage by Buyer upon receipt, be properly calibrated for Buyer's particular use, and be used, repaired, and maintained in strict accordance with the instructions set forth in Industrial Scientific's product literature. Repair or maintenance by non-qualified personnel will invalidate the warranty, as will the use of non-approved consumables or spare parts.

As with any other sophisticated product, it is essential and a condition of Industrial Scientific's warranty that all personnel using the products be fully acquainted with their use, capabilities and limitations as set forth in the applicable product literature. Buyer acknowledges that it alone has determined the intended purpose and suitability of the goods purchased.

It is expressly agreed by the parties that any technical or other advice given by Industrial Scientific with respect to the use of the goods or services is given without charge and at Buyer's risk; therefore, Industrial Scientific assumes no obligations or liability for the advice given or results obtained.



# Appendix

## Supplemental Information about Sensors and Gases

Table A.1. Sensor cross interference (percent response)

Target gas	Sensor type			
	Carbon Monoxide %	Hydrogen Sulfide %	Nitrogen Dioxide %	Sulfur Dioxide %
Carbon Monoxide	100.0	1.0	0.0	1.0
Hydrogen Sulfide	10.0	100.0	-8.0	1.0
Sulfur Dioxide	0.0	10.0	0.0	100.0
Nitrogen Dioxide	-20.0	-20.0	100.0	-100.0
Chlorine	-10.0	-20.0	90.0	-25.0
Chlorine Dioxide	—	—	—	—
Hydrogen Cyanide	15.0	10.0	1.0	50.0
Hydrogen Chloride	3.0	0.0	0.0	0.0
Phosphine	—	—	—	—
Nitric Oxide	10.0	1.0	0.0	1.0
Hydrogen	60.0	0.1	0.0	0.5
Ammonia	0.0	0.0	0.0	0.0

— No data available

*Note:* This table is provided as a guide only and is subject to change. The data reflect the percentage response of the sensor type when exposed to a known concentration of a target gas. For example, when the carbon monoxide sensor is exposed to carbon monoxide in the air sample, the gas concentration reading accurately reflects the actual concentration of carbon monoxide, so the sensor's response is said to be 100%. When an air sample contains hydrogen, it triggers a carbon monoxide reading. The carbon monoxide sensor's response to hydrogen is approximately 60% meaning that exposure to 100 ppm hydrogen will produce a reading of approximately 60 ppm carbon monoxide.

## Marking Requirements

Table A.2. ATEX and IECEx marking requirements

ATEX markings	IECEx markings
Industrial Scientific Corp.	Industrial Scientific Corp.
15205 USA	15205 USA
TANGO TX1	TANGO TX1
DEMKO 12 ATEX 1209126	IECEx UL12.0041
Ex ia I Ma	Ex ia I Ma
Ex ia IIC T4 Ga	Ex ia IIC T4 Ga
-40 °C ≤ Ta ≤ +50 °C	-40 °C ≤ Ta ≤ +50 °C
[Serial Number] [Month/Year of Production]	[Serial Number] [Month/Year of Production]

# Contact Information

## Industrial Scientific Corporation

1 Life Way

Pittsburgh, PA 15205-7500

USA

Web: [www.indsci.com](http://www.indsci.com)

Phone: +1 412-788-4353 or 1-800-DETECTS (338-3287)

E-mail: [info@indsci.com](mailto:info@indsci.com)

Fax: +1 412-788-8353

## Industrial Scientific France S.A.S.

5 Rue Frédéric Degeorge, CS 80097

62002 Arras Cedex,

France

Web: [www.indsci.com](http://www.indsci.com)

Téléphone : +33 (0)1 57 32 92 61

E-mail: [info@eu.indsci.com](mailto:info@eu.indsci.com)

Fax: +33 (0)1 57 32 92 67

## 英思科传感仪器（上海）有限公司

地址：中国上海市浦东金桥出口加工区桂桥路290号

邮编：201206

网址：[www.indsci.com](http://www.indsci.com)

电话：+86 21 5899 3279

传真：+86 21 5899 3280

E-mail：[info@ap.indsci.com](mailto:info@ap.indsci.com)

服务热线：+86 400 820 2515

To locate a nearby distributor of our products or an Industrial Scientific service center or business office, visit us at [www.indsci.com](http://www.indsci.com).

Rendez-vous sur notre site Web [www.indsci.com](http://www.indsci.com), si vous voulez trouver un distributeur de nos produits près de chez vous, ou, si vous recherchez un centre de service ou un bureau Industrial Scientific.

Besuchen Sie uns unter [www.indsci.com](http://www.indsci.com), um einen Vertriebshändler unserer Produkte oder ein Servicecenter bzw. eine Niederlassung von Industrial Scientific zu finden.

Para buscar un distribuidor local de nuestros productos o un centro de servicio u oficina comercial de Industrial Scientific, visite [www.indsci.com](http://www.indsci.com).

如需查找就近的产品经销商或 Industrial Scientific 服务中心或业务办事处，请访问我们的网站 [www.indsci.com](http://www.indsci.com)。

**INDUSTRIAL**  
**SCIENTIFIC**