

Making van der Pauw Resistivity and Hall Voltage Measurements Using the 4200A-SCS Parameter Analyzer

APPLICATION NOTE

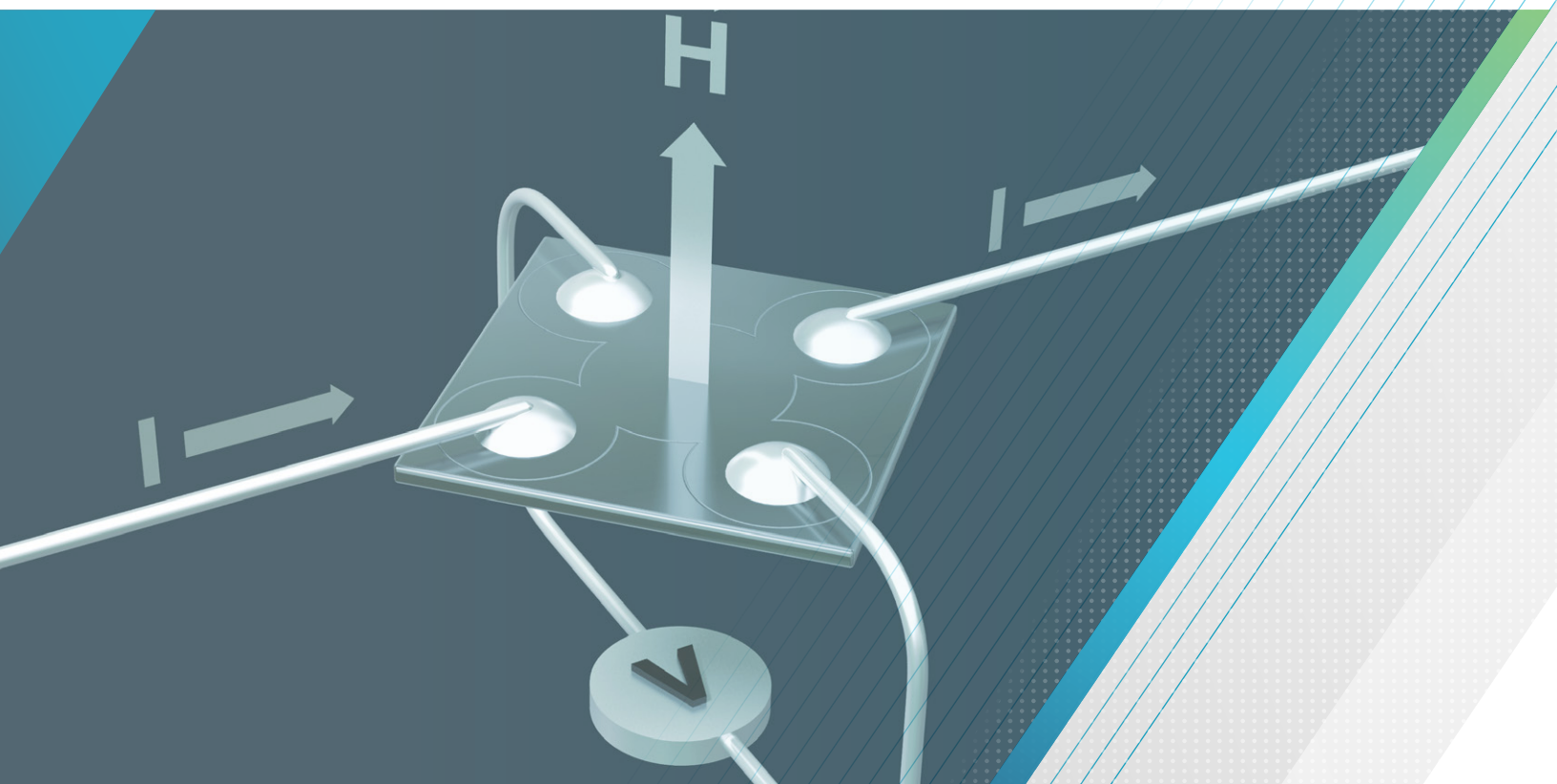

KEITHLEY
A Tektronix Company

Tektronix[®]

Introduction

Semiconductor material research and device testing often involves measuring the resistivity and Hall voltage of a sample. The resistivity of a semiconductor material is primarily dependent on the bulk doping. In a device, the resistivity can affect the capacitance, the series resistance, and the threshold voltage. Hall voltage measurements are used to derive the type of semiconductor (n or p), the free carrier density, and the mobility.

The electrical measurements for determining van der Pauw resistivity and Hall voltage of a semiconductor material usually requires a current source and a voltmeter. To automate measurements, a programmable switch is typically used to switch the current source and the voltmeter to all sides of the sample. However, the 4200A-SCS Parameter Analyzer with four source measure units (SMUs) and four preamps (for high resistance measurements) is an ideal solution because it can automatically make these measurements without the need for a programmable switch. The user can use either four medium power SMU (4200-SMU, 4201-SMU) or high power SMU (4210-SMU, 4211-SMU). For high resistance materials, the 4200-PA preamps are required. The 4200A-SCS includes built-in tests that automatically switch the function of the SMU to either a voltmeter or current source, as necessary, to make the series of measurements around the sample. The Hall voltage measurements require a magnetic field applied to the sample.

The 4200A-SCS includes interactive software for making van der Pauw and Hall voltage measurements on semiconductor materials. Tests for resistivity and Hall voltage are among many tests and projects that are included in the extensive library provided in the 4200A-SCS Clarius+ Software Suite. The van der Pauw and Hall voltage tests were added in Clarius V1.5 and V1.6. These particular tests include the calculations for determining surface or volume resistivity, Hall mobility, and Hall coefficient.

This application note provides an overview of the van der Pauw and Hall effect measurement methods and how to use the built-in applications that are included with the 4200A-SCS to perform these measurements.

Overview of the van der Pauw Resistivity Method

The resistivity of semiconductor materials is often derived using the van der Pauw (vdp) technique. This four-wire method is used on small, flat shaped samples of uniform thickness with four terminals. Current is forced through two terminals on the sample, and the voltage drop is measured across the opposite two terminals as shown in **Figure 1**:

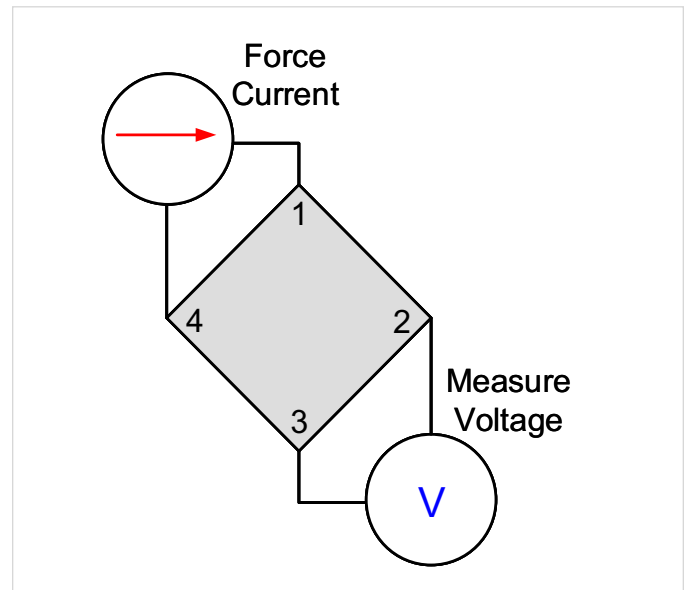

FIGURE 1. van der Pauw configuration.

This measurement is repeated eight times around the periphery of the sample using the SMU instrument configurations shown in **Figure 2**.

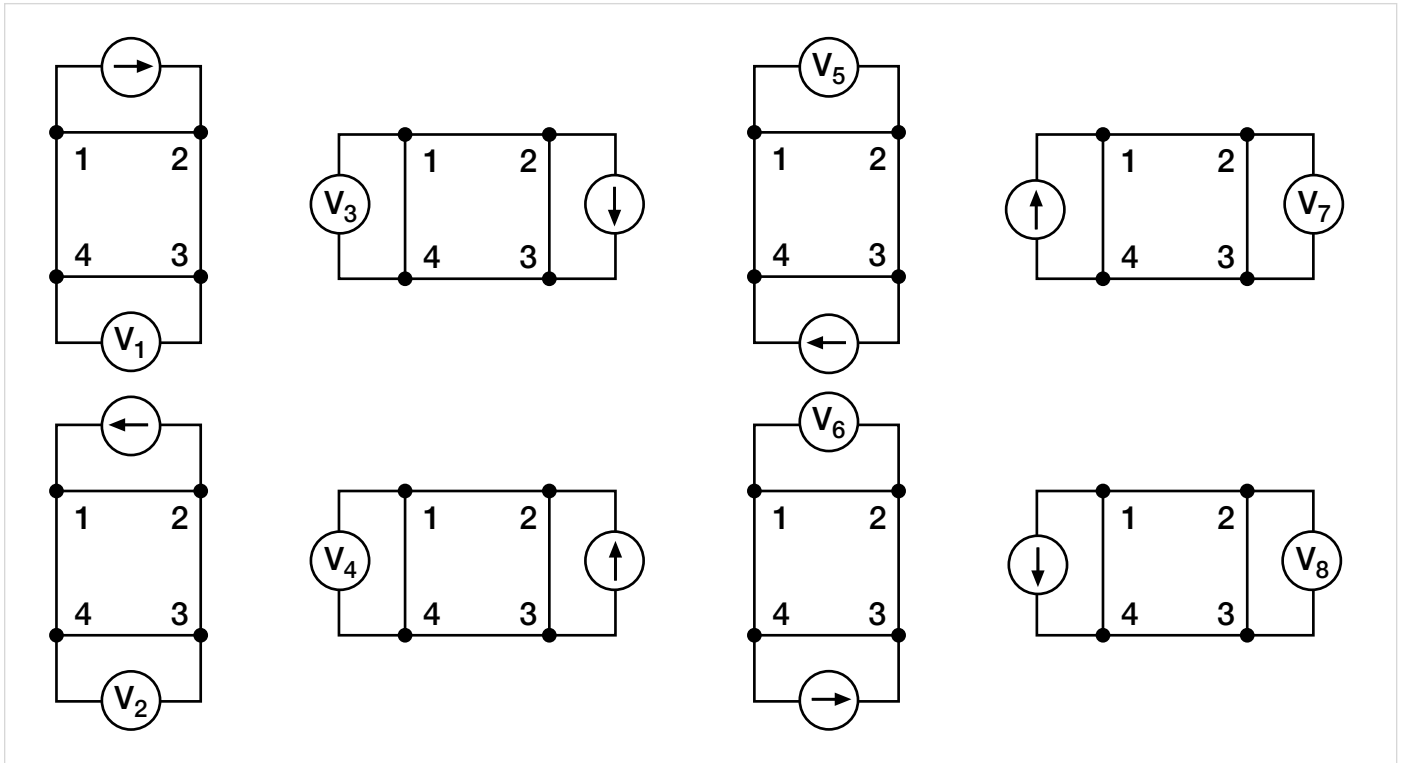

FIGURE 2. van der Pauw Resistivity Measurement Conventions.

The series of eight voltage measurements (V1-V8) and the test current (I) are used to calculate the resistivity (ρ) based on the following equations:

$$\rho_A = \frac{\pi}{\ln 2} f_A t_s \frac{(V_1 - V_2 + V_3 - V_4)}{4I}$$

$$\rho_B = \frac{\pi}{\ln 2} f_B t_s \frac{(V_5 - V_6 + V_7 - V_8)}{4I}$$

Where: ρ_A and ρ_B are volume resistivities in ohm-cm

t is the sample thickness in cm

V_1 - V_8 represent the voltages measured by the voltmeter

I is the current through the sample in amperes

f_A and f_B are geometrical factors based on sample symmetry and are related to the two resistance ratios Q_A and Q_B as shown in the following equations ($f_A = f_B = 1$ for perfect symmetry).

Q_A and Q_B are calculated using the measured voltages as shown in the following equations:

$$Q_A = \frac{V_1 - V_2}{V_3 - V_4}$$

$$Q_B = \frac{V_5 - V_6}{V_7 - V_8}$$

Also, Q and f are related as follows:

$$\frac{Q-1}{Q+1} = \frac{f}{0.693} \operatorname{arc} \cosh \left(\frac{e^{0.693/f}}{2} \right)$$

A plot of this function is shown in **Figure 3**. The value of “f” can be found from this plot once Q has been calculated.

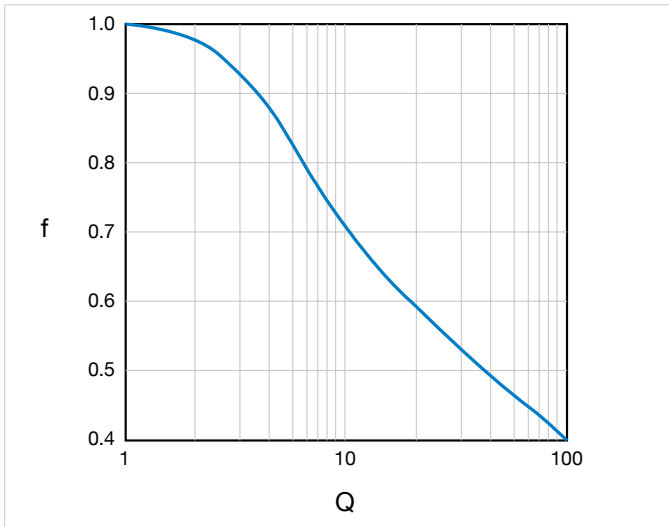

FIGURE 3. Plot of f vs Q.

Once ρ_A and ρ_B are known, the average resistivity (ρ_{AVG}) can be determined as follows:

$$\rho_{AVG} = \frac{\rho_A + \rho_B}{2}$$

Overview of Hall Voltage Measurements

Hall voltage measurements are important to semiconductor material characterization because from both the Hall voltage and the resistivity, the conductivity type, carrier density, and mobility can be derived. With an applied magnetic field, the Hall voltage is measured using the I-V measurement configurations below:

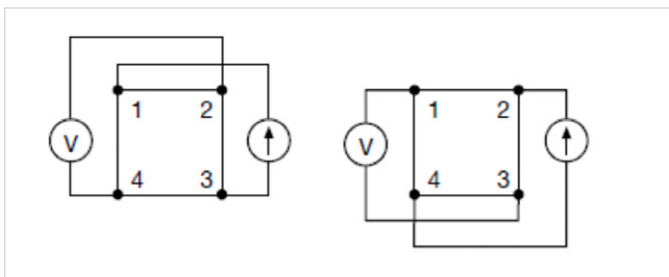

FIGURE 4. Hall voltage measurement configurations.

With a positive magnetic field, B, applied perpendicular to the sample, apply a current between terminals 3 and 1 (I31pBp) and measure the voltage drop (V24pBp) between terminals 2 and 4. Reverse the current (I31nBp) and measure the voltage drop (V24nBp) again. This current reversal method is done to correct for offset voltage. Next, apply current from terminal 2 to terminal 4 (I24pBp), and measure the voltage drop (V13pBp) between terminals 1 and 3. Reverse the current (I24nBp), and measure the voltage drop (V13nBp) again.

Reverse the magnetic field, Bn, and repeat the procedure again measuring the voltage drops V24pBn, V24nBn, V13pBn, and V13nBn.

From the eight Hall voltage measurements, the average Hall coefficient can be calculated as follows:

$$R_{HC} = \frac{t}{4BI} * (V24pBp - V24nBp + V24nBn - V24pBn) * (10^4)$$

$$I = I31pBp, I31nBp, I31nBn, I31pBn$$

$$R_{HD} = \frac{t}{4BI} * (V13pBp - V13nBp + V13nBn - V13pBn) * (10^4)$$

$$I = I24pBp, I24nBp, I24nBn, I24pBn$$

Where: R_{HC} and R_{HD} are Hall coefficients (cm^3/C)

t is the sample thickness (cm) (NOTE: For sheet Hall Coefficient, use no thickness applied.)

B is the magnetic flux density in Tesla ($\text{V}^*\text{s}/\text{m}^2$)

I is the current (A)

V represents the voltages (V)

10^4 for conversion from m^2 to cm^2

Once R_{HC} and R_{HD} have been calculated, the average hall coefficient ($R_{H_{AVG}}$) can be determined as follows:

$$R_{H_{AVG}} = \frac{R_{HC} + R_{HD}}{2}$$

From the van der Pauw resistivity (ρ_{AVG}), indicated as output parameter Volume_Resistivity, and the Hall coefficient ($R_{H_{AVG}}$), the Hall mobility (μ_H) can be calculated:

$$\mu_H = \frac{|R_{H_{AVG}}|}{\rho_{AVG}}$$

Using the 4200A for van der Pauw and Hall Voltage Measurements

The 4200A-SCS with four SMU and preamps simplifies van der Pauw and Hall voltage measurements because it contains built-in tests, which automate these measurements. When using the built-in tests, the four SMUs are connected to the four terminals of the sample as shown in **Figure 5**. For each measurement, the function of each SMU will change between a current source, voltmeter or common. Voltage drops and the test current from each of the eight tests are measured and then used to derive the resistivity or the Hall coefficient. The Hall voltage measurements require a magnetic field applied to the sample.

The Clarius+ Test Library includes three tests for van der Pauw and Hall mobility measurements. When in the Select view, these tests can be found in the Test Library by using the Materials filter on the right side of the screen as shown in **Figure 6**. These tests can be added to a project tree by selecting the test and then selecting Add. These tests were created from user modules in the *vdpulib* user library.

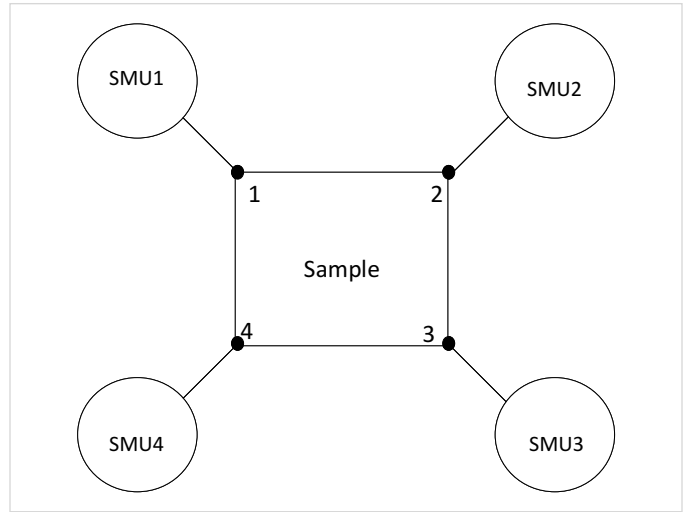

FIGURE 5. Four SMUs are connected to the four terminals of the sample under test.

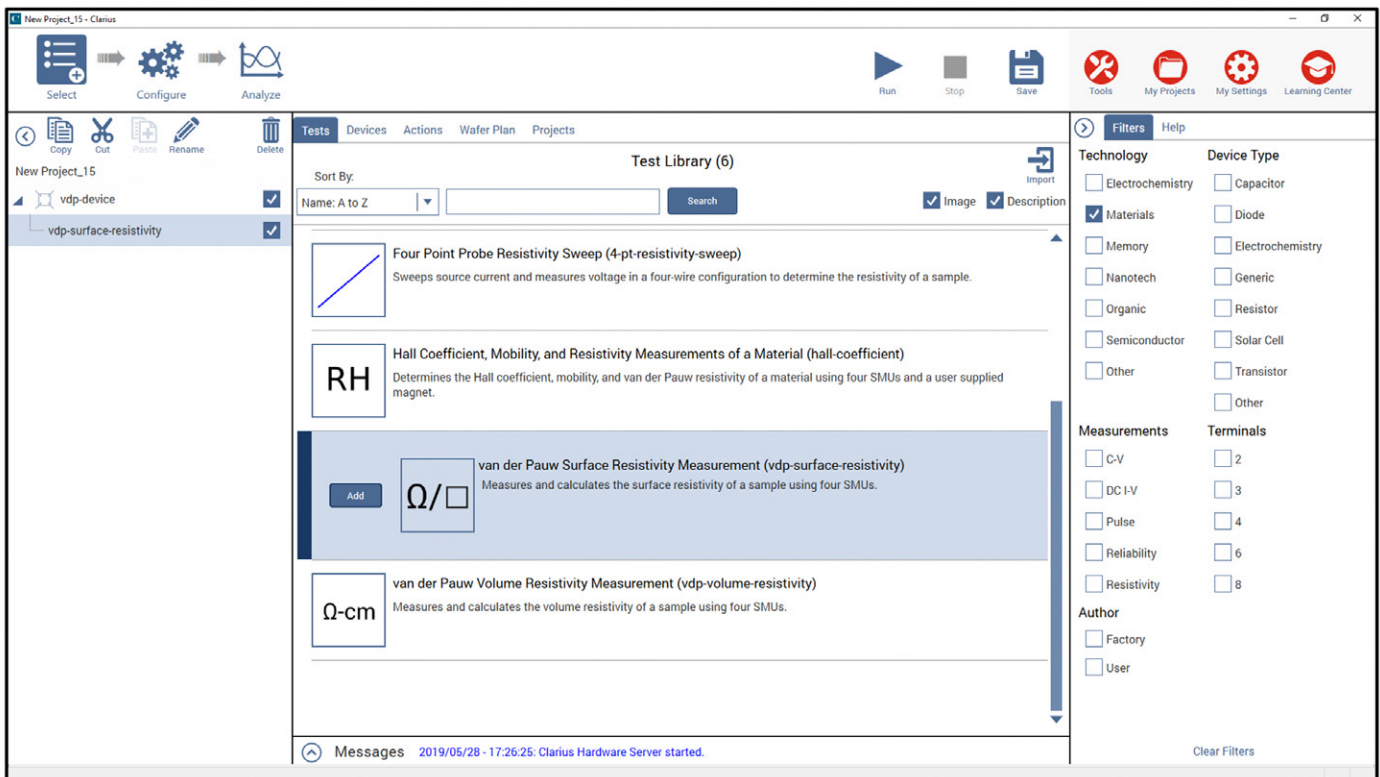

FIGURE 6. Selecting the van der Pauw resistivity and Hall Coefficient tests.

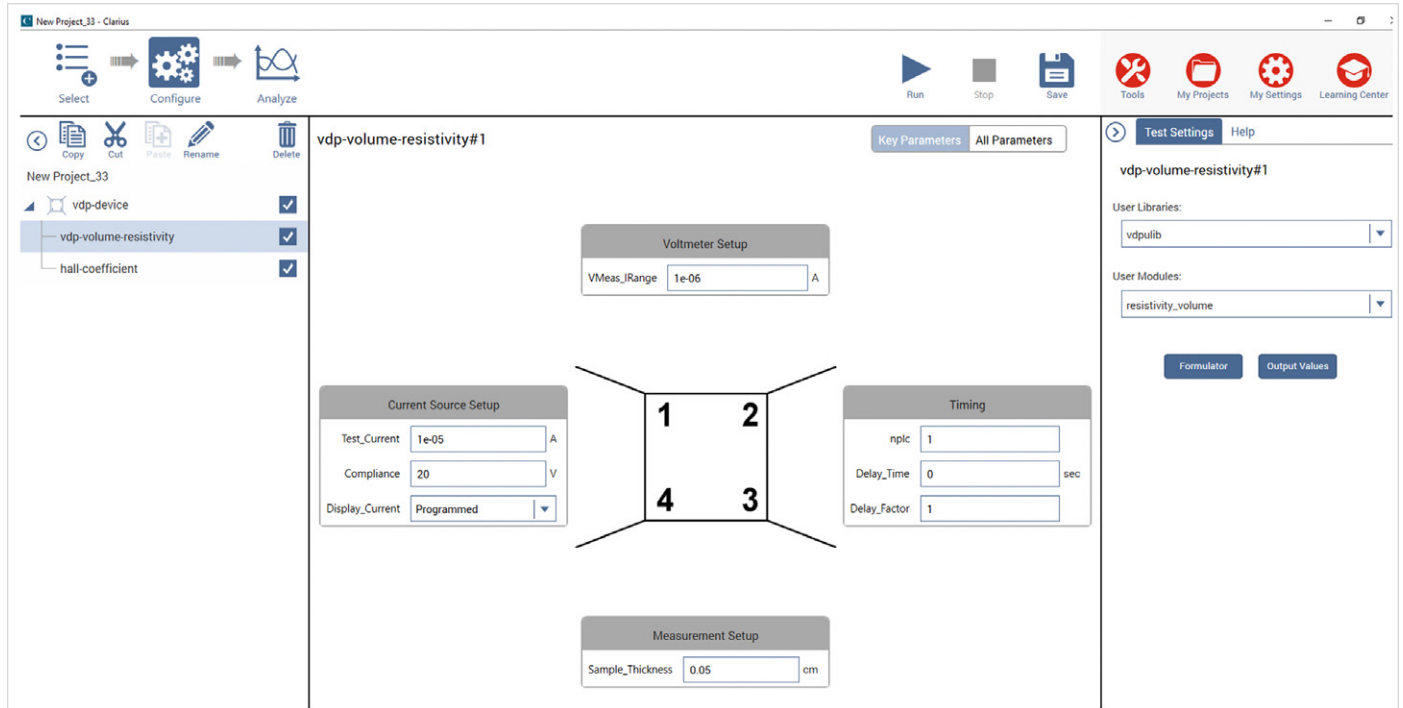

FIGURE 7. *vdp-volume-resistivity* test shown in the Configure view.

Using the van der Pauw Surface and Volume Resistivity Tests

The Test Library has two resistivity tests: ***vdp-surface-resistivity*** and ***vdp-volume-resistivity***. The ***vdp-surface-resistivity*** test measures and calculates the resistivity in units of Ω/square . For the ***vdp-volume-resistivity*** test, the user must enter the sample thickness and the resistivity is calculated in units of $\Omega\text{-cm}$. For both tests, current is forced and eight voltage measurements are made.

A screen capture of the Configure view of the ***vdp-volume-resistivity*** test is shown in **Figure 7**. The user enters the Input Parameters based on the sample requirements.

The Input Parameters for the vdp tests are listed in **Table 1**.

Once the input parameters are entered and the test is executed, measurements are made around the sample with the function of each SMU changing for each measurement. Each SMU will be configured as either a current source outputting the specified Test Current, a voltmeter (sourcing 0A), or a common. Specifically, for each test one SMU will be a current source,

Inputs	Units	Default Values	Range
Test Current (I)	A	1.00E-05	full range of I source values
Compliance	V	20	full range of V measure values
Display_Current		Programmed	Programmed or Measured
Current Source Range for SMU defined as voltmeters	A	1e-6	Full range of I source values
npIc		1	0.01 to 10
Delay_Time	s	0	
Delay_Factor	N/A	1	0-100
Sample Thickness (t)	cm	0.05	1e-7 to 1

TABLE 1. Input Parameters for van der Pauw Tests.

one SMU will be a common, and two SMUs will measure voltage after the user specified delay time. The voltage difference is calculated from the two SMUs voltage readings. These eight measurements and SMU configurations are displayed in **Figure 8**.

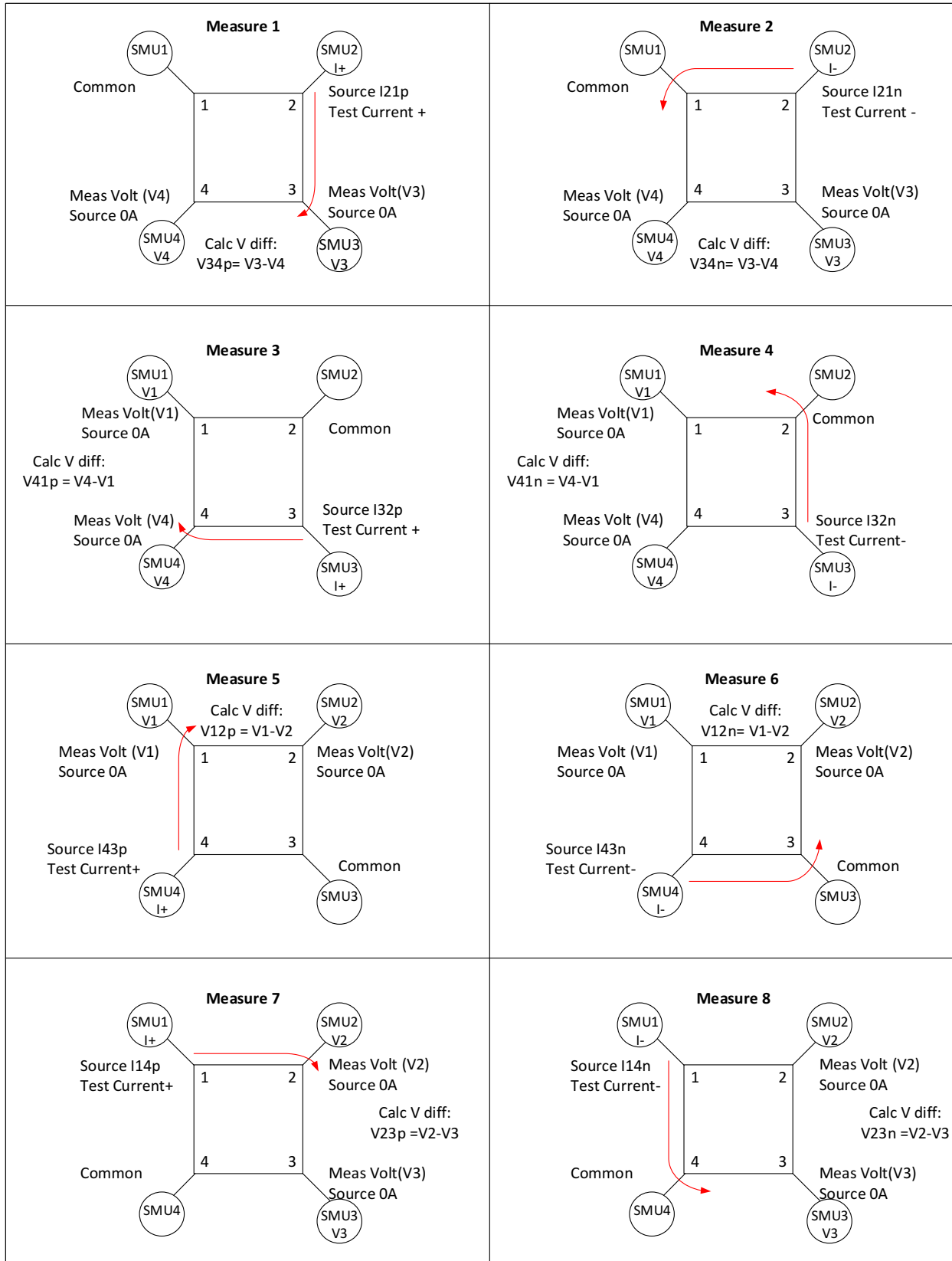

FIGURE 8. SMU configurations for the eight van der Pauw measurements.

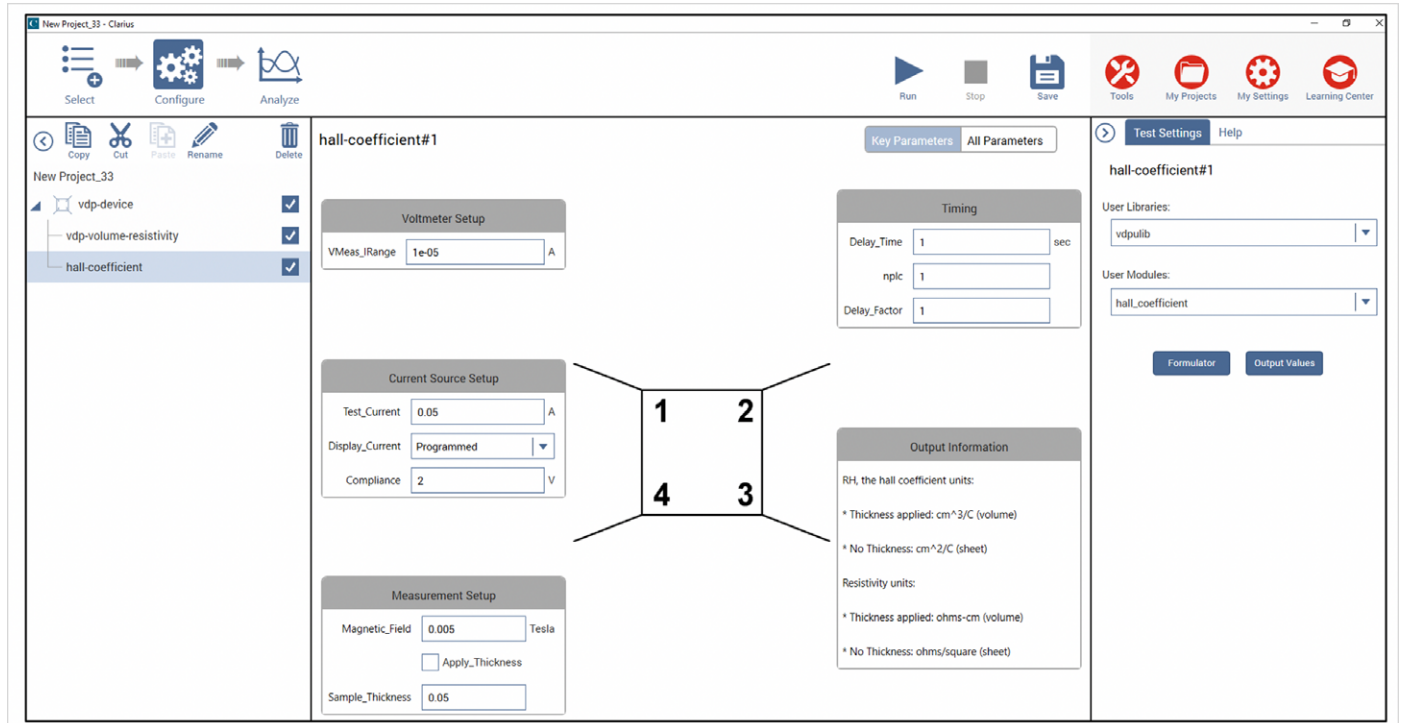

FIGURE 9. *hall-coefficient* test shown in the Configure view.

From the test current and the eight voltage differences, the resistivity is calculated as follows:

$$\rho_A = \left(\frac{\pi}{\ln 2} \right) * t * \frac{(V34p - V34n + V41p - V41n)}{4 * I}$$

$$\rho_B = \left(\frac{\pi}{\ln 2} \right) * t * \frac{(V12p - V12n + V23p - V23n)}{4 * I}$$

$$\text{Volume Resistivity} = \rho = \frac{\rho_A + \rho_B}{2} \text{ ohm-cm}$$

$$\text{Sheet Resistivity} = \sigma = \frac{\rho}{t} \text{ ohm/square}$$

Once the test is finished, the voltage differences and resistivity are displayed in the Analyze view sheet.

Below is a list of returned values:

Outputs for the vdp Tests:

- Test Current I (programmed value), V34p, V34n, V41p, V41n, V12p, V12n, V23p, V23n, ρA, ρB, ρ or σ
- If user wants to measure the test current then: I21p, V34p, I21n, V34n, I32p, V41p, I32n, V41n, I43p, V12p, I43n, V12n, I14p, V23p, I14n, V23n, ρA, ρB, ρ or σ

Using the Hall Coefficient Test

Using four SMU instruments, current is forced and eight voltage measurements are made using both a positive and negative magnetic field. The magnetic field is generated by a stationary magnet and the user is prompted to reverse the field.

The test called, **hall-coefficient**, can be found in the test library and added to a project tree. A screen capture of the test is shown in **Figure 9**.

Here is a description of the steps, when the **hall-coefficient** test is executed:

1. Once the *hall-coefficient* test is selected from the Test Library, the input parameters can be set in the Configure view. A list of the input parameters and their descriptions are found in **Table 2**.
2. Once the input parameters are entered, the test can be executed. First the resistivity measurements are made with no magnetic field. The Volume_Resistivity (ρ) is used in the calculation of the Hall coefficient.

Inputs	Units	Default Values	Range
Magnetic Field in Tesla (B)	T	0.1	0.001 to 2
Test Current (I)	A	1.00E-05	full range of I source values
Compliance	V	2	full range of V measure values
Display_Current		Programmed	Programmed or Measured
Current Source Range for SMU defined as voltmeters	A	1e-6	Full range of I source values
nplc		1	0.01 to 10
Delay_Time	s	0	0.01 to 60
Delay_Factor	N/A	1	0-100
Sample Thickness (t)	cm	0.05	1e-10 to 1
Apply_Thickness		No	Yes/No

TABLE 2. Input Parameters for the *hall-coefficient* test.

Measure#	Magnetic Flux	Current Applied Between	Current Name	Voltage Measured Between	Voltage Name
1	+B	3-1	I31pBp	2-4	V24pBp
2	+B	1-3	I31nBp	2-4	V24nBp
3	+B	2-4	I24pBp	1-3	V13pBp
4	+B	4-2	I24nBp	1-3	V13nBp
5	-B	3-1	I31pBn	2-4	V24pBn
6	-B	1-3	I31nBn	2-4	V24nBn
7	-B	2-4	I24pBn	1-3	V13pBn
8	-B	4-2	I24nBn	1-3	V13nBn

TABLE 3. Current Source and Voltage Measurement Names.

- After the volume resistivity is derived, the user is prompted to turn on the positive magnetic field (B+) in Tesla. The message should read:

Please apply a magnetic field with positive polarity to the sample and then press OK to continue.
- Once OK is pressed, then the first four measurements are made with the B+. These measurements are defined in **Table 3**.
- When the measurements are done, the user is prompted to change the polarity of the magnetic field (B-). The message should read:

Please reverse the polarity of the magnetic field so that the magnetic field is negative and then press OK to continue.
- After OK is pressed, then the four measurements are repeated with B-. These measurements are also defined in **Table 3 and illustrated in Figure 10**.
- When the measurements are done, the following prompt is displayed:

Please remove any magnetic field from the sample and then press OK to continue.
- The test is done, when the user presses OK.
- The output parameters are listed at the end of this section.

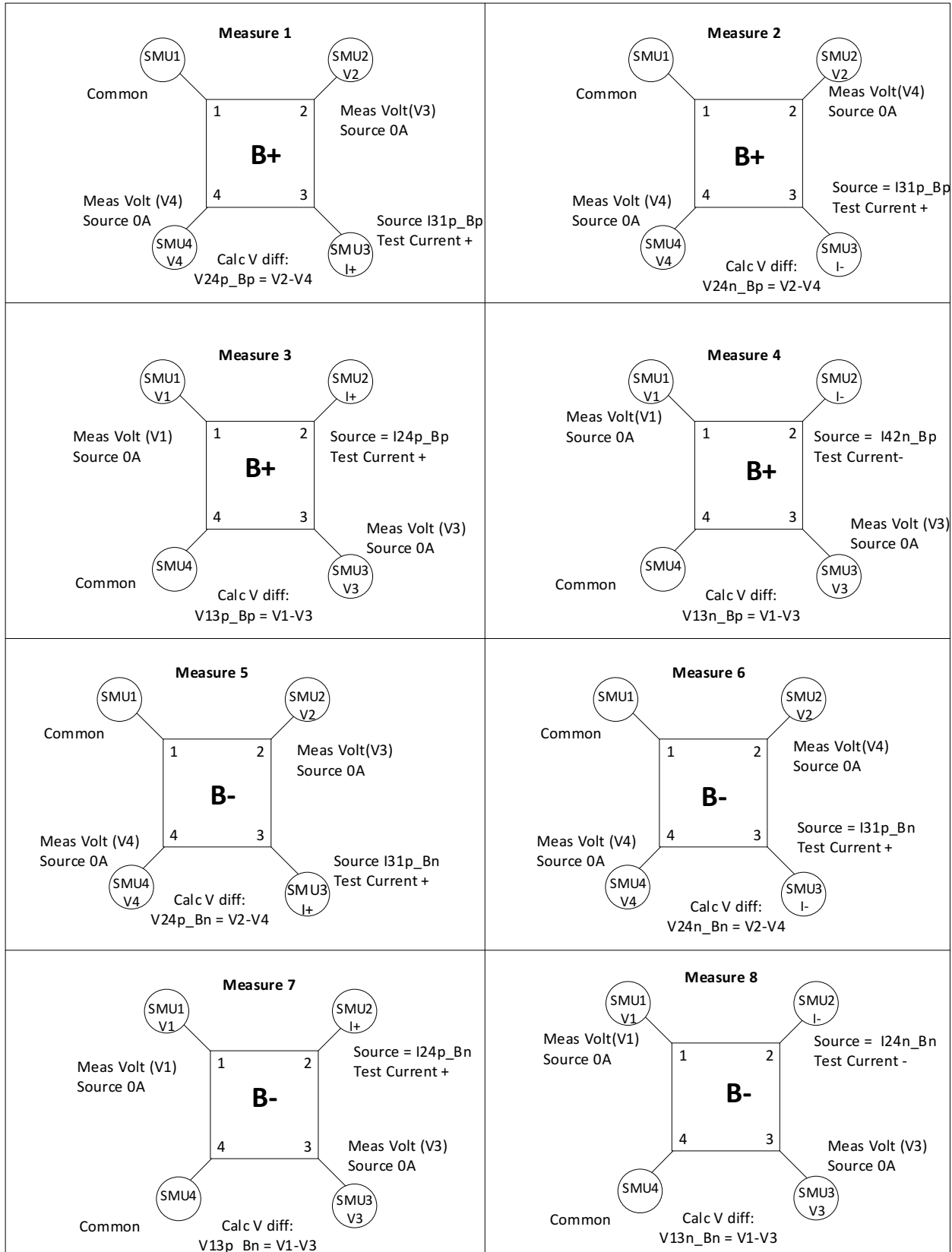

FIGURE 10. SMU configurations for the eight Hall voltage measurements.

Output Parameters for the *hall-coefficient* test

The output parameters of the *hall-coefficient* test are listed below and appear in the Sheet of the Analyze view in Clarius:

RH, mobility, Resistivity, I21p, V34p, I21n, V34n, I32p, V41p, I32n, V41n, I43p, V12p, I43n, V12n, I14p, V23p, I14n, V23n, I31pBp, V24pBp, I31pBn, V24pBn, I31nBp, V24nBp, I24pBp, V13pBp, I24nBp, V13nBp, I31pBn, V24pBn, I31nBn, V24nBn, I24pBn, V13pBn, I24nBn, V13nBn, thickness_in_cm, RHC, RHD

NOTE: For no applied thickness, the units of resistivity are ohms/square and the units of RH are cm^2/C .

Sources of Error and Measurement Considerations

For successful resistivity measurements, the potential sources of errors need to be considered.

Electrostatic Interference

Electrostatic interference occurs when an electrically charged object is brought near an uncharged object. Usually, the effects of the interference are not noticeable because the charge dissipates rapidly at low resistance levels. However, high resistance materials do not allow the charge to decay quickly and unstable measurements may result. The erroneous readings may be due to either DC or AC electrostatic fields.

To minimize the effects of these fields, an electrostatic shield can be built to enclose the sensitive circuitry. The shield is made from a conductive material and is always connected to the low impedance (FORCE LO) terminal of the SMU instrument.

The cabling in the circuit must also be shielded. Low noise shielded triax cables are supplied with the 4200A-SCS.

Leakage Current

For high resistance samples, leakage current may degrade measurements. The leakage current is due to the insulation resistance of the cables, probes, and test fixturing. Leakage current may be minimized by using good quality insulators, by reducing humidity, and by using guarding. A guard is a conductor connected to a low impedance point in the

circuit that is nearly at the same potential as the high impedance lead being guarded. The inner shield of the triax connector of the SMU is the guard terminal. This guard should be run from the SMU to as close as possible to the sample. Using triax cabling and fixturing will ensure that the high impedance terminal of the sample is guarded. The guard connection will also reduce measurement time since the cable capacitance will no longer affect the time constant of the measurement.

Light

Currents generated by photoconductive effects can degrade measurements, especially on high resistance samples. To prevent this, the sample should be placed in a dark chamber.

Temperature

Thermoelectric voltages may also affect measurement accuracy. Temperature gradients may result if the sample temperature is not uniform. Thermoelectric voltages may also be generated from sample heating caused by the source current. Heating from the source current will more likely affect low resistance samples because, a higher test current is needed to make the voltage measurements easier. Temperature fluctuations in the laboratory environment may also affect measurements. Since semiconductors have a relatively large temperature coefficient, temperature variations in the laboratory may need to be compensated for by using correction factors.

Carrier Injection

To prevent minority/majority carrier injection from influencing resistivity measurements, the voltage difference between the two voltage sensing terminals should be kept at less than 100mV, ideally 25mV, given that the thermal voltage, kt/q , is approximately 26mV. The test current should be kept to as low as possible without affecting the measurement precision.

Conclusion

Using four SMUs and the built-in tests, van der Pauw measurements on semiconductor materials are easily achieved with the 4200A-SCS Parameter Analyzer. With a user supplied magnet, Hall mobility can also be determined. For testing low resistance materials, such as conductors, use a system based on the Keithley 3765 Hall Effect Card including the 2182A Nanovoltmeter.

Bibliography

ASTM, F76-08. *Standard Method for Measuring Hall Mobility and Hall Coefficient in Extrinsic Semiconductor Single Crystals.*

van der Pauw, L. J. *A Method of Measuring Specific Resistivity and Hall Effects of Discs of Arbitrary Shape.* Philips Rec. Repts., 1958: 13 1.

Schroder, Dieter K. *Semiconductor Material and Device Characterization.* John Wiley & Sons, Inc., 3rd Edition, 2015.

Low Level Measurements, Keithley Instruments, Cleveland, Ohio, 2014.

Contact Information:

Australia 1 800 709 465
Austria* 00800 2255 4835
Balkans, Israel, South Africa and other ISE Countries +41 52 675 3777
Belgium* 00800 2255 4835
Brazil +55 (11) 3759 7627
Canada 1 800 833 9200
Central East Europe / Baltics +41 52 675 3777
Central Europe / Greece +41 52 675 3777
Denmark +45 80 88 1401
Finland +41 52 675 3777
France* 00800 2255 4835
Germany* 00800 2255 4835
Hong Kong 400 820 5835
India 000 800 650 1835
Indonesia 007 803 601 5249
Italy 00800 2255 4835
Japan 81 (3) 6714 3086
Luxembourg +41 52 675 3777
Malaysia 1 800 22 55835
Mexico, Central/South America and Caribbean 52 (55) 56 04 50 90
Middle East, Asia, and North Africa +41 52 675 3777
The Netherlands* 00800 2255 4835
New Zealand 0800 800 238
Norway 800 16098
People's Republic of China 400 820 5835
Philippines 1 800 1601 0077
Poland +41 52 675 3777
Portugal 80 08 12370
Republic of Korea +82 2 565 1455
Russia / CIS +7 (495) 6647564
Singapore 800 6011 473
South Africa +41 52 675 3777
Spain* 00800 2255 4835
Sweden* 00800 2255 4835
Switzerland* 00800 2255 4835
Taiwan 886 (2) 2656 6688
Thailand 1 800 011 931
United Kingdom / Ireland* 00800 2255 4835
USA 1 800 833 9200
Vietnam 12060128

* European toll-free number. If not accessible, call: +41 52 675 3777

Rev. 02.2018

Find more valuable resources at TEK.COM

Copyright © Tektronix. All rights reserved. Tektronix products are covered by U.S. and foreign patents, issued and pending. Information in this publication supersedes that in all previously published material. Specification and price change privileges reserved. TEKTRONIX and TEK are registered trademarks of Tektronix, Inc. All other trade names referenced are the service marks, trademarks or registered trademarks of their respective companies.

092419 AH 1KW-60641-1

