
780C Multi-Interface Interoperability Tester for Video and Audio

User Guide

Rev: A1



Table of Contents

1	Overview of the 780C Multi-Interface Interoperability Tester	5
1.1	Scope of this User Guide	5
1.2	Changes to this User Guide	5
1.3	Introducing the 780C Multi-Interface Interoperability Tester	5
1.4	Overview of 780C features	6
1.4.1	Standard features	6
1.4.2	Network Analyzer features	7
1.4.3	Cable and Repeater test features	7
1.4.4	Auto EDID Test	7
1.4.5	Auxiliary Channel Analyzer for DDC monitoring features	8
1.4.6	What is in the 780C shipping box	8
2	Physical Interfaces of the 780C Multi-Interface Interoperability Tester	9
2.1	Video Interfaces	9
2.2	Audio interfaces	10
2.3	Administrative Interface	10
3	General Operation	12
3.1	Power Considerations	12
3.2	Tilt Bail	12
3.3	Navigating through the 780C User Interface	13
3.3.1	Home Menu items	13
3.3.2	Back Navigation	15
3.3.3	Status Bar	16
3.4	Calibrating the LCD	18
4	Using the 780C Test Instrument to Video and Audio Pattern Tests on Sink Devices	20
4.1	Making Physical Connections - HDMI	20
4.1.1	Connecting the 780C to the Display Device - HDMI	20
4.1.2	Connecting the 780C to the Display Device - HDBaseT	21
4.1.3	Connecting the 780C to the Display Device - SDI	21
4.1.4	Connecting the 780C to the Display Device - Analog	22
4.2	Selecting a Signal Type and Resolution	22
4.2.1	Procedures for Selecting a Signal Type	22
4.2.2	Procedures for Selecting an Resolution and Frame Rate – HDMI and HDBaseT	24
4.2.3	Procedures for Enabling AVmute	27
4.2.4	Procedures for Selecting a Resolution and Frame Rate – SDI	28
4.3	Rendering Test Patterns on an HDTV	29
4.3.1	Procedures for Outputting Test Patterns	29
4.4	Using Custom Test Image Packs	41
4.5	Outputting 3D Test Patterns through HDMI or HDBaseT	46
4.5.1	Configurations for Rendering 3D Bitmaps on an HDMI or HDBaseT Sink Device	46
4.5.2	Procedures for Obtaining 3D Bitmaps on HDMI or HDBaseT Sink Device	47
4.5.3	Procedures for Rendering 3D Bitmaps or 3D Test Patterns on HDMI or HDBaseT Sink Device	47
4.6	How to Scroll or Pan a Bitmap Pattern	50
4.6.1	Guidelines for Scrolling Bitmaps	50
4.6.2	Procedures for Scrolling Bitmaps	50
4.6.3	Procedures for Panning Bitmaps	51
4.7	Testing Digital Audio on an HDTV or A/V Receiver	54
4.7.1	Connecting the 780C to an Audio Rendering Device	54
4.7.2	Procedures for Testing a Display with Dolby Digital or DTS Audio Test Patterns	56
4.7.3	Procedures for Testing a Display with Dolby Digital or DTS Sine Wave Clips	60
4.7.4	Procedures for Testing with Programmable Sine Waves	62

- 4.7.5 Testing HDMI Audio Return Channel (ARC) 780C only 65
- 5 Using the 780C Test Instrument to Test HDMI and HDBaseT Protocols on Sink Devices..... 68**
 - 5.1 Testing HDCP on an HDMI, HDBaseT HDTV, Projector or Repeater Device 68
 - 5.1.1 Configurations for Testing HDCP on an HDMI Sink Device 68
 - 5.1.2 Configurations for Testing HDCP on an HDBaseT Sink Device 68
 - 5.1.3 Procedures for Testing HDCP on an HDMI or HDBaseT Sink Device 69
 - 5.2 Verifying the EDID on an HDMI, HDTV, HDBaseT Projector or HDMI Repeater Device 71
 - 5.2.1 Configurations for Verifying and Viewing the EDID on an HDMI Sink Device 71
 - 5.2.2 Configurations for Verifying and Viewing the EDID on an HDBaseT Sink Device or Input of an HDBaseT Distribution Device 72
 - 5.2.3 Procedures for Testing and Viewing the EDID on an HDMI/HDBaseT Sink Device 72
 - 5.2.4 Workflow for Comparing EDIDs 76
 - 5.2.5 Procedures for Comparing EDIDs 76
 - 5.3 Viewing the CEC devices on an HDMI/HDBaseT network 79
 - 5.3.1 Configurations for Testing CEC on an HDMI/HDBaseT Sink Device 79
 - 5.3.2 Procedures for Testing CEC on an HDMI/HDBaseT Sink Device 81
 - 5.4 Multi-protocol (HDCP, EDID and CEC) testing on an HDMI or HDBaseT HDTV or Projector 83
 - 5.4.1 Configurations for running multi-protocol tests on an HDMI Sink Device 83
 - 5.4.2 Configurations for running multi-protocol tests on an HDBaseT Sink Device 83
 - 5.4.3 Procedures for running multi-protocol tests on an HDMI or HDBaseT Sink Device 83
- 6 Using the 780C Test Instrument to Test HDMI or HDBaseT Source Devices 86**
 - 6.1 Testing Video from an HDMI Source Device 86
 - 6.1.1 Connection Configurations for Testing HDMI Source Devices 86
 - 6.1.2 Connection Configurations for Testing HDBaseT Outputs on Repeater and Distribution Devices 87
 - 6.1.3 Procedures for Viewing Video on an HDMI/HDBaseT Source Device 88
 - 6.1.4 Viewing the Incoming 4K HDMI/HDBaseT Video on a Connected Display using Passthrough 93
 - 6.1.5 Viewing Video Metadata from an HDMI/HDBaseT Source Device 94
 - 6.1.6 Procedures for Viewing Video on an SDI Source Device 98
 - 6.1.7 Viewing Video Metadata from an SDI Source Device 102
 - 6.2 Viewing Source Data Island Packets on HDMI and HDBaseT 104
 - 6.2.1 Configurations for Viewing the Data Island Packets from an HDMI or HDBaseT Source Device 104
 - 6.2.2 Procedures for Viewing the HDMI/HDBaseT Data Island Packets from a Source Device 105
 - 6.3 Testing HDCP Max Devices on an HDMI Source Devices and Outputs of HDBaseT distribution Devices 107
 - 6.3.1 Configurations for Testing Max Devices an HDMI Source Device Supports 107
 - 6.3.2 Procedures for Testing Max Devices a Source Device Supports 107
 - 6.3.3 Procedures for disabling HDCP on the 780C HDMI/HDBaseT Out port - GUI 110
 - 6.3.4 Procedures for disabling HDCP on the 780C out port 110
 - 6.4 Testing Audio of an HDMI Source Device or at the Output of an HDBaseT Distribution Device 111
 - 6.4.1 Configurations for Testing Audio on an HDMI Source Device 111
 - 6.4.2 Configurations for Testing Audio on the Output of an HDBaseT Distribution Device 112
 - 6.4.3 Procedures for Testing Audio from an HDMI/HDBaseT Source Device 113
 - 6.4.4 Procedures for Testing Audio from an HDMI/HDBaseT Source Device 117
 - 6.4.5 Procedures for Audible Monitoring of LPCM Audio from an Digital Video Source Device 122
 - 6.5 Testing an HDMI or HDBaseT Source’s Response to EDIDs 126
 - 6.5.1 Configurations for Testing an HDMI Source Devices Response to an EDID 126
 - 6.5.2 Configurations for Testing an HDBaseT Device’s Output Response to an EDID 126
 - 6.5.3 Procedures for Testing an HDMI Source Devices Response to an EDID 127
- 7 Using the 780C Test Instrument Installer Test Utility 133**
 - 7.1 Diagnosing HDMI and HDBaseT Interoperability Problems toward the Source - Upstream 134
 - 7.1.1 Connection Configurations for Testing HDMI Source Devices 134
 - 7.1.2 Connection Configurations for Testing HDBaseT Source Devices 135
 - 7.1.3 Procedures for Testing Upstream (Source Test) with the Installer Utility 135

- 7.2 Diagnosing HDMI and HDBaseT Interoperability Problems at the Sink - Downstream 139
 - 7.2.1 Connection Configurations for Testing HDMI Sink Devices 139
 - 7.2.2 Connection Configurations for Testing HDBaseT Sink Devices 139
 - 7.2.3 Procedures for Testing Downstream (Sink Test) with the Installer Utility 140
- 7.3 Diagnosing HDMI/HDBaseT Interoperability Problems with a Repeater 143
 - 7.3.1 Connection Configurations for Testing HDMI Repeater Devices 143
 - 7.3.2 Connection Configurations for Testing HDBaseT Repeater Devices 143
 - 7.3.3 Procedures for Testing Repeaters (Repeater Test) with the Installer Utility 144
- 7.4 Diagnosing HDMI/HDBaseT Interoperability Problems in an HDMI/HDBaseT Network 147
 - 7.4.1 Connection Configurations for Testing HDMI Links 147
 - 7.4.2 Connection Configurations for Testing HDBaseT Links 147
 - 7.4.3 Procedures for Testing HDMI Networks (Links) with the Installer Utility 147
- 8 Using the 780C to Monitor the HDMI/HDBaseT CEC and DDC channel 150**
 - 8.1 Auxiliary Channel Analyzer (ACA) Transactions 150
 - 8.2 Auxiliary Channel Analyzer – Emulation Monitoring of DDC on Sink 151
 - 8.2.1 Configurations for Monitoring DDC Transactions with ACA on HDMI Sink Devices 152
 - 8.2.2 Configurations for Monitoring DDC Transactions with ACA on HDBaseT Sink Devices 152
 - 8.2.3 Monitoring DDC Transactions with ACA on HDMI or HDBaseT Sink Devices 153
 - 8.2.4 Configurations for Monitoring DDC Transactions with ACA on HDMI Source Devices 156
 - 8.2.5 Configurations for Monitoring DDC Transactions with ACA on HDBaseT Source Devices 156
 - 8.2.6 Procedures for Monitoring the DDC Transactions using the Auxiliary Channel Analyzer on HDMI or HDBaseT Source Devices 157
 - 8.3 Configuration for Monitoring DDC Transactions with the ACA on an HDMI or HDBaseT Repeater or distribution device 160
 - 8.3.1 Procedures for Running an Auxiliary Channel Analyzer Test on HDMI/HDBaseT Repeater or Distribution Devices 161
 - 8.4 Auxiliary Channel Analyzer – Passive Monitoring 165
 - 8.4.1 Configurations for Passively Monitoring CEC and or DDC Transactions with ACA on an HDMI System 165
 - 8.4.2 Procedures for Passive Monitoring DDC transactions and hot plug events with the Auxiliary Channel Analyzer on HDMI Devices 165
 - 8.5 Auxiliary Channel Analyzer – Monitoring of CEC Messages 168
 - 8.5.1 Procedures for Passive Monitoring HDMI CEC messages with the Auxiliary Channel Analyzer 169
- 9 Using the 780C Test Instrument to Test HDMI Cable or Repeaters 172**
 - 9.1 HDMI Cable or Repeater Test 172
 - 9.1.1 Configurations for Running an HDMI Cable or Repeater Test 172
 - 9.1.2 Procedures for Running an HDMI Cable or Network (“Repeater”) Test 173
 - 9.2 HDMI Frame Compare Test 176
 - 9.2.1 Configuration for Running an HDMI Frame Compare Test 176
 - 9.2.2 Procedures for Running the Frame Compare Test 176
 - 9.2.3 Procedures for Running the Remote PRN Test 178
- 10 Running the Automated EDID Tests on HDMI Source Devices 181**
 - 10.1 HDMI Auto EDID Test 181
 - 10.1.1 Procedures for Configuring a Set of EDIDs for the Auto EDID Test 181
 - 10.1.2 Configurations for Running an Auto EDID Test 183
 - 10.1.3 Procedures for Running the Auto EDID Test 184
 - 10.1.4 Viewing the Auto-EDID Test report 189
- 11 Creating and Using Custom Formats, EDIDs, Bitmaps and Menus 191**
 - 11.1 Creating and Using Custom Formats 191
 - 11.1.1 Workflow for Using Custom Formats 191
 - 11.1.2 Procedures for Creating and Loading Custom Formats 191
 - 11.2 Adding Reference EDIDs for Use in Testing HDMI Devices 195
 - 11.2.1 Workflow for Importing EDIDs into the 780C 195
 - 11.2.2 Procedures for Importing EDIDs into the 780C 195

11.2.3	Procedures for Saving an EDID into the 780C	197
11.3	Using Custom Bitmaps	200
11.3.1	Workflow for Importing Bitmaps	200
11.3.2	Workflow for loading bitmaps from the SD card	200
11.3.3	Procedures for Importing Bitmaps	200
11.3.4	Procedures for Loading Bitmaps from SD Card	203
11.4	Creating Custom Menus	204
11.4.1	To create a custom menu:	205
11.4.2	To access custom menus:	205
12	Command Interface.....	208
12.1	Guidelines for Using the Command Line	208
12.2	Procedures for Enabling the Command Line Interface through USB Port	208
12.3	Procedures for using the Command Line Interface through RS-232 Port (780C only).....	210
12.4	Procedures for Entering Commands.....	211
13	Using the Keypad.....	228
13.1	Connecting a Keypad.....	228
13.2	Enabling and Configuring an RS-232 Keypad	228
13.3	Keypad Functionality.....	229
13.4	Selecting a Format (Timing).....	230
13.5	Selecting a Test Pattern (Image)	232
13.6	Programming a Test Sequence using the keypad	233
13.7	Programming a Test Sequence in the UserKeys file	234
14	Upgrading the 780C	236
14.1	Upgrading the Firmware and Gateware on your 780C Handheld Test Instrument for HDMI.....	236

1 Overview of the 780C Multi-Interface Interoperability Tester

This section provides an overview of the 780C Multi-Interface Interoperability Tester. The 780C provides HDMI Tx port and an HDMI Rx port operating up to 300MHz pixel and TMDS rates for testing devices which support 4K resolutions. The 780C also has analog outputs.

1.1 Scope of this User Guide

This User Guide documents the complete operation of the 780C Multi-Interface Interoperability Tester.

Note: Please be sure to check the Quantum Data website for updates to this User Guide.

1.2 Changes to this User Guide

The following changes have been made to this User Guide since its last version:

- This is a new User Guide

1.3 Introducing the 780C Multi-Interface Interoperability Tester

The 780C Multi-Interface Interoperability Tester is a battery-powered, portable multimedia pattern generator that enables you to conduct quick, on-site verification testing of your HDMI, HDBaseT and 3G-SDI systems and analog video displays. The 780C is equipped with both reference source and reference sink HDMI, HDBaseT and 3G-SDI interfaces allowing you to test audio, video and protocols—HDCP, EDID, CEC & infoframes—of any type of HDMI, HDBaseT and 3G-SDI device: sources, repeaters and sinks. Because the 780C has both an digital video outputs and inputs, you can test cables and systems with splitters, extenders and switches as well with the optional pixel error test feature. You can also test hybrid digital video systems comprised of HDMI, HDBaseT and 3G-SDI devices.

A color touch display makes the 780C easy and convenient to use. When testing a digital video source device you can toggle between operating the unit through the touch screen and viewing the incoming video from the source.





Note: 780C Image above shows the front edge with the SD Card slot which is used for storing and loading bitmaps, reports and for recovery in the event of a failed upgrade.

1.4 Overview of 780C features

The 780C Multi-Interface Interoperability Tester provides a rich set of features. The following is a list of available options and the key features and benefits of each:

1.4.1 Standard features

The following features are standard with the 780C:

- Pattern testing for HDTVs - Enables you to conduct pattern testing for an HDTV through the digital video and analog component outputs. Provides dozens of patterns with variation options on most.
- Custom bitmaps and pattern scrolling – The 780C enables you to import bitmaps for use in pattern testing. You can initiate a scroll of these bitmaps with user control over the rate and extent of horizontal movement.
- Create custom formats using the standalone Format Editor.
- 3D bitmap pattern testing – The 780C enables you to import 3D bitmaps for use in pattern testing. You can create your own bitmaps from any stereoscopic images you have using the Quantum Data Bitmap Conversion Tool available from the Quantum Data website: http://www.quantumdata.com/apps/3D/BMP_conv.asp. There are some sample 3D bitmaps on this webpage as well.
- Video confidence test of an HDMI, HDBaseT or 3G-SDI source device – The 780C enables you to view the incoming video on the 780C's LCD screen. 780C enables the incoming image to be routed out the digital video output connector if unused. 780C also enables scrolling to view an entire unscaled 4K image received on the HDMI and HDBaseT input ports.
- Audio confidence test of an HDMI, HDBaseT or 3G-SDI source device – The 780C enables you to listen to the incoming LPCM audio through the 780C's headphone jack on the front edge or through an embedded speaker. There will be no sound when compressed audio is received on the incoming HDMI stream.
- Audio Return Channel confidence test of an HDMI 1.4 A/V receiver – The 780C can emulate an ARC Tx device on its HDMI IN port. Note: The 780C does not support enabling ARC on the AV receiver, therefore you will have to enable ARC through some other means.

- Audio testing for AVRs and HDTVs – The 780C provides multi-channel digital audio test patterns through the HDMI, HDBaseT., 3G-SDI, SPDIF and optical outputs. A variety of audio patterns and formats are provided at sampling rates from 32kHz up to 192kHz and bit depths of 16, 20 and 24. Format supported are Dolby Digital and DTS compressed formats and lossless compressed or high bit rate HDMI formats.
- Installer Utility – Provides simplified diagnostics of HDMI and HDBaseT interoperability problems in an installation. The Installer utility enables installers to connect the 780C into an HDMI/HDBaseT network and quickly conduct diagnostics without required detailed knowledge of protocols.
- Command line interface for automated testing.

1.4.2 Network Analyzer features

The following Network Analyzer features are available:

- HDCP test of an HDMI or HDBaseT sink or input to a repeater device – The 780C enables you to run an HDCP functional test on an HDMI or HDBaseT sink device directly or through a repeater device.
- EDID test of an HDMI or HDBaseT HDTV, projector or input to a repeater device – The 780C enables you to run an EDID functional test on an HDMI or HDBaseT sink device directly or through a repeater device. You can view the entire EDID in human readable text. You can also run a portion of EDID compliance test.
- Video test of an HDMI, HDBaseT or SDI source device – The 780C provides an HDMI, HDBaseT or SDI input for testing HDMI, HDBaseT or SDI source devices. You can run a verification test of a video source which includes timing and format information and an indication of whether the video is HDCP content protected.
- Data Island test of an HDMI or HDBaseT source device – The 780C provides an HDMI/HDBaseT input for testing HDMI or HDBaseT source devices. You can view the inframes and other data islands.
- Audio test of an HDMI, HDBaseT or 3G-SDI source device – The 780C provides HDMI, HDBaseT and 3G-SDI inputs for testing source devices. You can run a verification test of an audio source which includes decoding of the audio IEC headers, audio inframes and audio sample packet headers (for HDMI and HDBaseT and parsing out of the channel status bits for 3G-SDI as well).
- EDID test of HDMI or HDBaseT source device or outputs – The 780C's HDMI or HDBaseT input ports can be provisioned with any EDID you have access to. You can verify that a source device responds properly to the provisioned EDID. The EDID could be a known-good EDID or an EDID that you have created specifically for testing.
- HDCP test of an HDMI or HDBaseT source device – The 780C enables you to run a test to determine how many HDCP devices an HDMI or HDBaseT source can support during HDCP authentication.
- CEC ping test of any HDMI device – The 780C enables you to run a CEC ping test on an HDMI device.

1.4.3 Cable and Repeater test features

The following features are available with the Cable and Repeater test *option*:

- Cable & Repeater test – Because the 780C has both digital video inputs and outputs, you can loop a cable or entire distribution networks comprised of splitters, extenders, repeaters, switches, even hybrid networks with HDMI, HDBaseT or 3G-SDI components, from the 780C's output to input and run a pseudo-random noise pattern test to determine pixel errors on the TMDS lines. The feature also runs a continuity test on the HDMI or HDBaseT DDC test pair, CEC bus, the +5V line and the hot plug lead. The Repeater test also shows you the hot plug delay between the downstream side and the upstream side and the pulse width. The Cable & Repeater Test enable you to test a cable, repeater or distribution network if the source and sink ends are collocated. If the source and sink ends are not collocated then you need to use the Frame Compare test described below.

1.4.4 Auto EDID Test

The following features are available with the Auto EDID test *option*:

- Select a series of EDIDs to test a source's handling of them.

- Emulate the EDIDs on the 780C HDMI or HDBaseT Input port.
- Test runs automatically and flags improper handling. Checks for proper VIC, timing, video type, color depth and sampling mode.

1.4.5 Auxiliary Channel Analyzer for DDC monitoring features

The following features are available with the Auxiliary Channel Analyzer test *options*:

- DDC monitoring with Auxiliary Channel Analyzer (ACA) – The 780C ACA enables you to monitor HDMI or HDBaseT CEC DDC transactions such as HDCP and EDID as well as hot plug related events while emulating an HDMI or HDBaseT source and/or an HDMI or HDBaseT sink device(s) in a system. You can also monitor passively between two HDMI/HDBaseT devices. When monitoring passively you can also view the +5V status.

1.4.6 What is in the 780C shipping box

The 780C instrument shipping container includes the items listed in Table 1-1 below:

Table 1-1: 780C Shipping Box Contents	
Item Description	Part No.
780C Multi-Interface Interoperability Tester.	00-00236
12V DC (40 W) Power Supply / Adapter / Charger.	25-00106
Line cord for 12V Power Supply.	30A00400A03
Cable: HDMI-to-HDMI Type A.	30-00146
Cable: VGA to (3) RCA adaptor.	30-00203
Cable: USB.	30-00163

2 Physical Interfaces of the 780C Multi-Interface Interoperability Tester

This section describes the administration, video and audio interfaces on the 780C test instrument:

2.1 Video Interfaces

Table 2-1 below describes the video interfaces on the 780C test instrument, these interfaces are used to render test patterns for testing consumer electronic HDTVs and computer displays.

Table 2-1: 780C Video Interfaces	
Video Interface	Description
HDMI (1) Output Type A	Single HDMI output connector. Supports HDMI 1.4x: <ul style="list-style-type: none"> ▪ Bit Depth: 24/30/36 bit. ▪ Colorimetry: RGB, YCbCr. ▪ Sampling: 4:4:4, 4:2:2, 4:2:0. ▪ Pixel rate: Timings up to 300MHz for 4K x 2K resolutions. ▪ DVI support through HDMI to DVI adapter cable (RGB, 4:4:4, 24 bit). ▪ Audio: LPCM, Dolby Digital and DTS (more details below).
HDBaseT (1) Output RJ-45	Single HDBaseT output connector. Supports HDBaseT 1.x: <ul style="list-style-type: none"> ▪ Bit Depth: 24/30/36 bit. ▪ Colorimetry: RGB, YCbCr. ▪ Sampling: 4:4:4, 4:2:2, 4:2:0. ▪ Pixel rate: Timings up to 300MHz for 4K x 2K resolutions. ▪ DVI support through HDMI to DVI adapter cable (RGB, 4:4:4, 24 bit). ▪ Audio: LPCM, Dolby Digital and DTS (more details below).
3G-SDI (1) Output BNC	3G-SDI output connector. <ul style="list-style-type: none"> ▪ Bit Depth: 24/30/36 bit. ▪ Colorimetry: YCbCr. ▪ Sampling: 4:4:2. ▪ Data rate: Timings up to 2.97Gbps. ▪ Audio: LPCM, Dolby Digital and DTS.
Analog Output – Component and VGA (HD15F)	<ul style="list-style-type: none"> ▪ Bit Depth: 24 bit color depth. ▪ Colorimetry: RGB, YPbPr. ▪ Pixel rate: 80MHz. ▪ Sync types: separate and composite.
HDMI (1) Input Type A	Single link HDMI input connector. Supports HDMI 1.4x: <ul style="list-style-type: none"> ▪ Colorimetry: RGB, YCbCr. ▪ Sampling: 4:4:4, 4:2:2, 4:2:0. ▪ Pixel rate: Timings up to 300MHz for 4K x 2K resolutions.
HDBaseT (1) Input RJ-45	Single link HDBaseT input connector. Supports HDBaseT 1.x: <ul style="list-style-type: none"> ▪ Colorimetry: RGB, YCbCr. ▪ Sampling: 4:4:4, 4:2:2, 4:2:0. ▪ Pixel rate: Timings up to 300MHz for 4K x 2K resolutions.
3G-SDI (1) Input BNC 5	Single link HDMI input connector. <ul style="list-style-type: none"> ▪ Colorimetry: YCbCr. ▪ Sampling: 4:2:2. ▪ Data rate: Timings up to 2.97Gbps.

2.2 Audio interfaces

Table 2-2 below describes the audio interfaces supported on the 780C test instrument.

Table 2-2: 780C Audio Interfaces	
Interface	Description
HDMI (1) Output Type A	Single HDMI output connector. Supports HDMI 1.4x: <ul style="list-style-type: none"> ▪ Channels: 8. ▪ Bits per sample: 16, 20, 24. ▪ Sampling rates (kHz): 32.0, 44.1, 48.0, 88.2, 96.0, 176.4, 192.0. ▪ Formats: LPCM, Dolby Digital (clips), DTS (clips)
HDBaseT (1) RJ-45	Single HDBaseT output connector. Supports HDBaseT 1.x: <ul style="list-style-type: none"> ▪ Channels: 8. ▪ Bits per sample: 16, 20, 24. ▪ Sampling rates (kHz): 32.0, 44.1, 48.0, 88.2, 96.0, 176.4, 192.0. ▪ Formats: LPCM, Dolby Digital (clips), DTS (clips)
SPDIF - RCA	SPDIF RCA audio connector: <ul style="list-style-type: none"> ▪ Channels: 8 (clips) ▪ Bits per sample: 16, 20, 24. ▪ Sampling rates (kHz): 32.0, 44.1, 48.0, 96.0 ▪ Formats: LPCM, Dolby Digital (clips), DTS (clips)
Optical – JIS FOS	Optical audio connector: <ul style="list-style-type: none"> ▪ Channels: 8 (clips) ▪ Bits per sample: 16, 20, 24. ▪ Sampling rates (kHz): 32.0, 44.1, 48.0 ▪ Formats: LPCM, Dolby Digital (clips), DTS (clips)
HDMI (1) Input (Audio Return Channel) Type A	HDMI ARC SPDIF: <ul style="list-style-type: none"> ▪ Channels: 8 (clips) ▪ Bits per sample: 16, 20, 24. ▪ Sampling rates (kHz): 32.0, 44.1, 48.0, 96.0 ▪ Formats: LPCM, Dolby Digital (clips), DTS (clips)

2.3 Administrative Interface

The 780C is equipped with a USB interface. This interface is used to download custom bitmaps and to upgrade firmware and issue commands. The USB interface is a peripheral device. There are two modes:

- COM - Command Mode. Used for sending commands to set the interface, select formats and patterns.
- Disk - Mass Storage Mode. Used for downloading bitmaps, audio clips and upgrading firmware or gateway.



3 General Operation

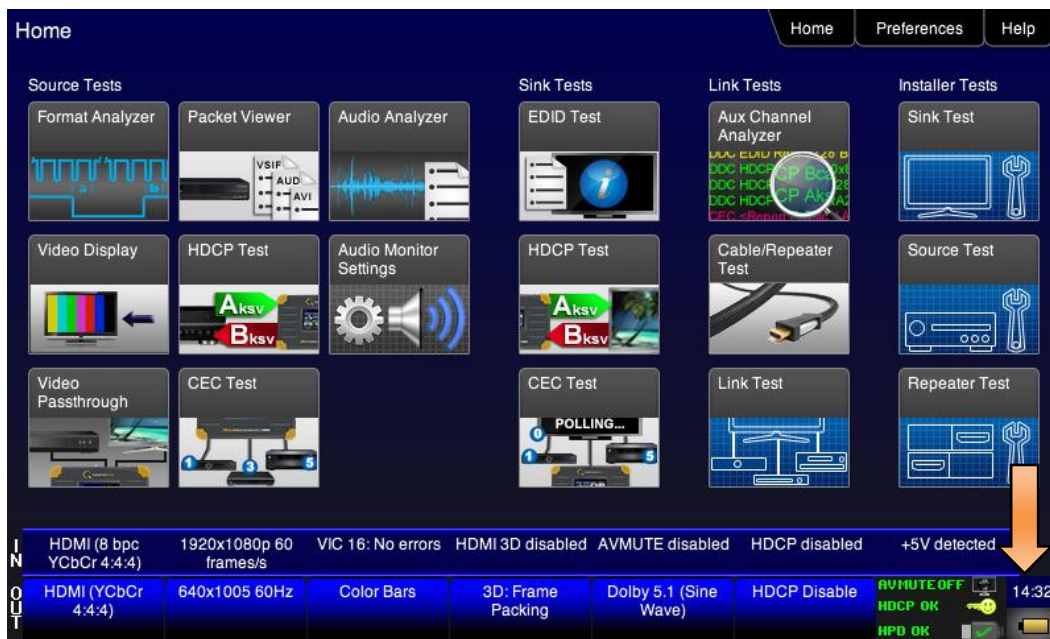
This section describes power up, power usage and general operation.

3.1 Power Considerations

The 780C has a rocker style power switch on the back panel. Refer to the photo below.

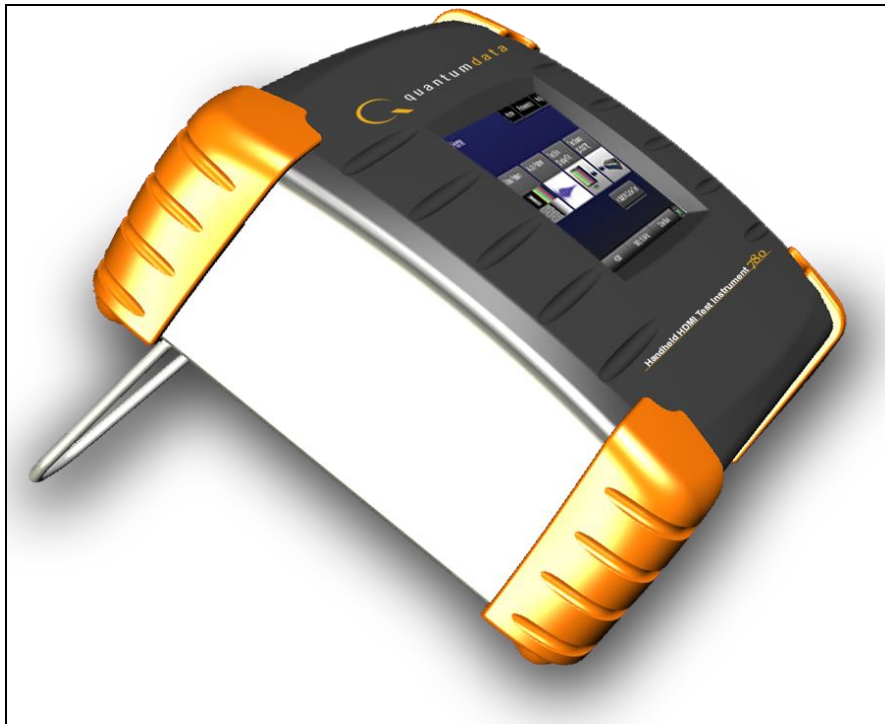


The 780C is supplied with the Part No 25-00106 12V DC power supply and charger as well as a part number 30A00400A03 line cord.



3.2 Tilt Bail

The 780C has support bail for convenience in viewing. This is depicted in the illustration below. (The illustration shows the 780; however, the 780C tilt bail operates in the same manner.)



3.3 Navigating through the 780C User Interface

The 780C user interface is a color touch screen display 800 by 480. A single touch will activate an item on the screen or take you down to a lower level menu. A + indicates that you have to double touch to navigate down to a lower level menu.

3.3.1 Home Menu items

The 780C's Home screen is shown below.



Table 3-1 below shows functions available from the Home screen.

Table 3-1: Top Level Menu			
Item	Submenu - Pattern	Third Level Menu	Value
Top Menu Bar	Home / Back navigation	See Below	Enables you to navigate back to the previous screen.
	Preferences Page 1	Audible Touch	<ul style="list-style-type: none"> ▪ Off ▪ On
		Screen Brightness	<ul style="list-style-type: none"> ▪ Min ▪ 25% ▪ 50% ▪ 75% ▪ Max
		USB Mode	<ul style="list-style-type: none"> ▪ COM for commands ▪ Disk for downloading files and upgrades
		Startup Mode	<ul style="list-style-type: none"> ▪ Set the 780's menu configuration to the default menu (shown throughout this User Guide). ▪ Custom Menu – Utilize a configuration that you have created.
	Custom Menu	<ul style="list-style-type: none"> ▪ Enter to navigate to custom menu screen. 	
	Preferences Page 2	Hot Plug Formats	<ul style="list-style-type: none"> ▪ On – 780C automatically select the formats in the EDID of the connected HDTV. ▪ Off – 780C will not automatically select the formats in the EDID of the connected HDTV.
AVMute on Format Change		<ul style="list-style-type: none"> ▪ On – AVMute will occur when the resolution is changed on the 780C HDMI output. ▪ Off – AVMute will occur when the resolution is changed on the 780C HDMI output. 	

		RS-232 Baud Rate	<ul style="list-style-type: none"> Configure the baud rate of the RS-232 interface on the 780C (N/A to 780).
		RS-232 Keypad Mode	<ul style="list-style-type: none"> Off – Keypad connected to RS-232 is disabled. On – Keypad connected to RS-232 is enabled.
	Help	Upgrades	<ul style="list-style-type: none"> USB Storage Flash Application Flash FPGA Flash
		Touchscreen	<ul style="list-style-type: none"> Calibrate the touch screen display
Source Tests Buttons	Format Analyzer	Viewing Source Data Island Packet	
	Video Display	Testing Video from an HDMI Source Device	
	Video Passthrough	Viewing the Incoming 4K Video on a Connected Display using Passthrough	
	Packet Viewer	Viewing Source Data Island Packet	
	HDCP Test	Testing HDCP Max Devices on an HDMI Source Device	
	CEC Test	Viewing the CEC devices on an HDMI network	
	Audio Analyzer	Testing Audio of an HDMI Source Device	
	Audio Monitor	Procedures for Monitoring LPCM Audio from a Source Device (780C only)	
Sink Tests Buttons	EDID Test	Verifying the EDID on an HDMI HDTV or HDMI Repeater Device	
	HDCP Test	Testing HDCP on an HDMI HDTV or HDMI Repeater Device	
	CEC Test	Viewing the CEC devices on an HDMI network	
Link Tests Buttons	Aux Channel Analyzer	Procedures for Monitoring Auxiliary Channel events and transactions	
	Cable/Repeater Test	Using the 780C Test Instrument to Test HDMI Cable or Repeaters	
	Link Test	Procedures for Installer Utility	
Installer Tests Buttons	Sink Tests	Using the 780C Test Instrument Installer Utility	
	Source Tests	Using the 780C Test Instrument Installer Utility	
	Repeater Tests	Using the 780C Test Instrument Installer Utility	

3.3.2 Back Navigation

When you navigate away from the Home screen a white arrow will appear in the upper left next to the name of the of the screen you are on. You can navigate to the previous screen by touch selecting this arrow. In the example below, touch selecting the upper left area on or near the white, left facing arrow next to **Signal Type** will take you to the previous screen.



3.3.3 Status Bar

The 780C has a status bar on the bottom of the screen.



The items in the status bar are described in the Table 3-2.

Table 3-2: Status Bar		
Type	Status Item	Function
HDMI/HDBaseT/SDI IN	Video Type Status	Indicates the status of video on the HDMI/HDBaseT/SDI Rx ports. This includes: <ul style="list-style-type: none"> Video interface: HDMI or DVI, HDBaseT or SDI Color depth: 8, 10, 12 Video type: RGB or YCbCr Sampling mode: 4:4:4, 4:2:2, 4:2:0 Note: When SDI is active on the input, the Video Type is always YCbCr and the sampling is always 4:2:2.
	Video Resolution Status	Indicates the video resolution on the HDMI Rx port. This includes: <ul style="list-style-type: none"> Horizontal Active in pixels Vertical Active in pixels Frame rate

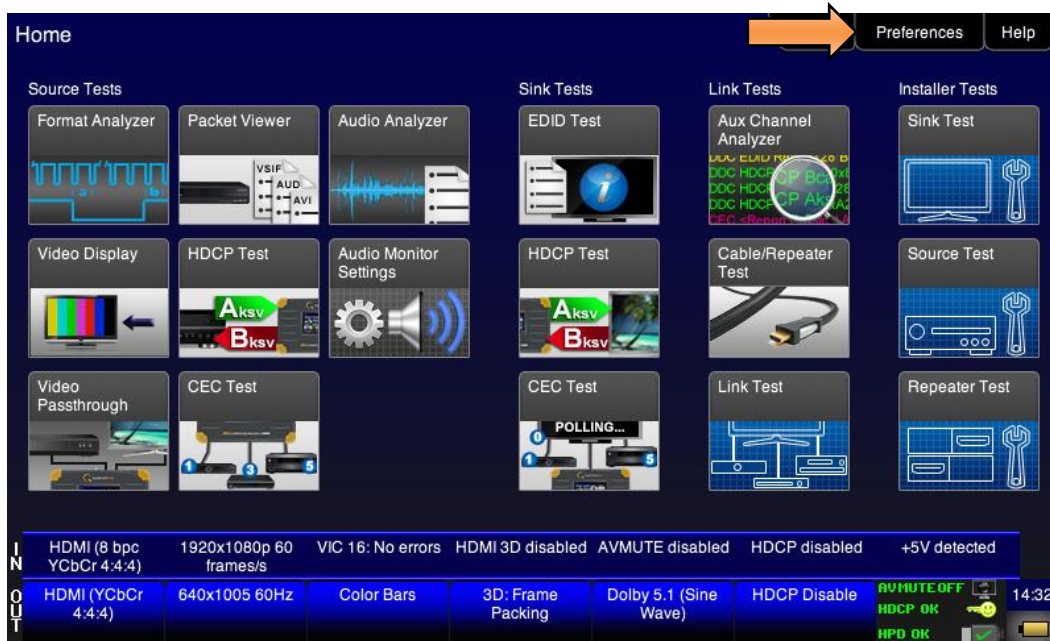
	Video Identification Status	Indicates the video resolution on the HDMI Rx port. This includes: <ul style="list-style-type: none"> Horizontal Active in pixels Vertical Active in pixels Frame rate
	3D Status	Indicates the status of 3D video for HDMI or HDBaseT. This includes: <ul style="list-style-type: none"> 3D enabled or disabled 3D format
	AVMute status	<ul style="list-style-type: none"> Indicates the AVmute status, enabled or disabled. Applies only to HDMI and HDBaseT.
	HDCP Status	Indicates whether the incoming video is encrypted with HDCP.
	+5V Status	Indicates whether +5V is detected from the HDMI or HDBaseT source.
HDMI/HDBaseT/SDI OUT	Video Type Status/Selection	Indicates the video on the HDMI/HDBaseT/SDI Tx ports. This includes: <ul style="list-style-type: none"> Video interface: HDMI or DVI Color depth: 8, 10, 12 Video type: RGB or YCbCr Sampling mode: 4:4:4, 4:2:2, 4:2:0 <p>Note: When SDI is active on the output, the Video Type is always YCbCr and the sampling is always 4:2:2.</p>
		Provides access to the Video Signal Type screen.
	Video Resolution Status/Selection	Indicates the video resolution on the HDMI Tx port. This includes: <ul style="list-style-type: none"> Horizontal Active in pixels Vertical Active in pixels Frame rate
		Provides access to the Video Format screen.
	Video Pattern Status/Selection	Indicates the video pattern on the HDMI Tx port.
		Provides access to the Video Pattern screen.
3D Format Status/Configuration	Indicates the status of 3D video. This includes: <ul style="list-style-type: none"> 3D enabled or disabled 3D format 	
	Provides access to the 3D video configuration screen.	
Audio Status	Indicates the Audio status: <ul style="list-style-type: none"> Audio format Audio channels Audio sampling rate 	

	HDCP Status	Indicates whether the incoming video on the HDMI In port is encrypted with HDCP.
	AVMute HDCP Status +5V Status	Indicates the status of the following for HDMI or HDBaseT: <ul style="list-style-type: none"> ▪ AVMute active/inactive status ▪ HDCP active/inactive status ▪ +5V present/not present status

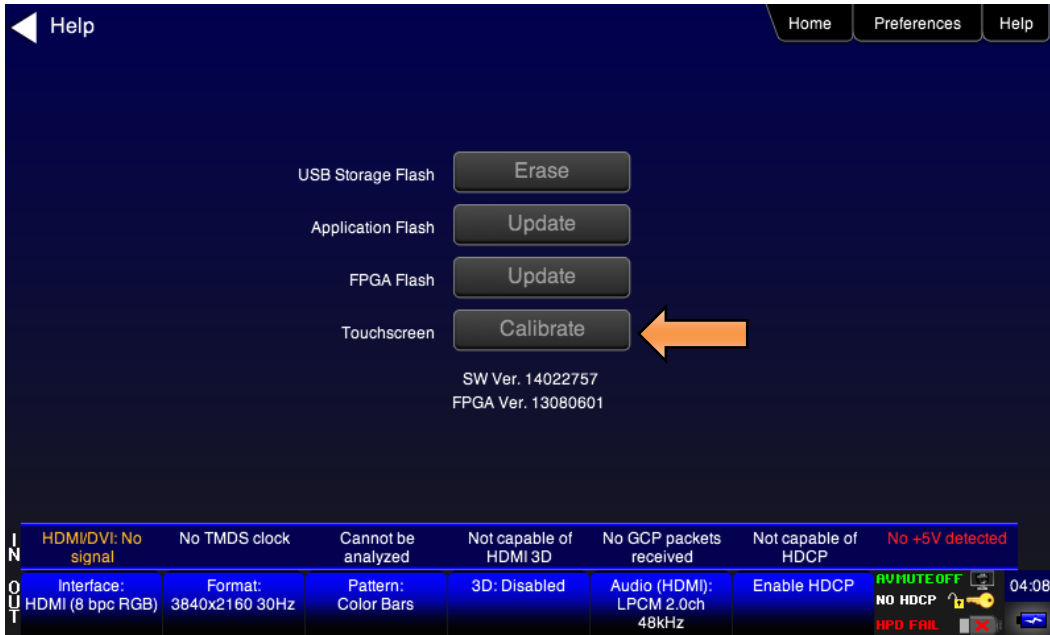
3.4 Calibrating the LCD

It is recommended that you calibrate the LCD display prior to using the 780C Test Instrument. Use the following procedures to perform the calibration.

1. From the **Home** menu, navigate to the Help menu by pressing the **Help** activation button on the upper status bar. The **Home** menu is shown below.



The **Help** menu appears as shown below:



2. Touch select the **Calibrate** activation button. A screen appears instructing you to press each of four red squares.



When you finish touch selecting the fourth box, the calibration is completed and you will return to the Home menu.

3. If the calibration fails and you cannot access the menus, establish a command line session and enter the calibration command:

TCAL

This will cause the screen to display the calibration screen again.

4 Using the 780C Test Instrument to Video and Audio Pattern Tests on Sink Devices

This chapter provides procedures for running audio and video pattern tests on high definition sink devices such as HDTVs and projectors. The features and functions described in this chapter are provided with the standard 780C; no options are required. The following signal types are supported.

- HDMI (via the HDMI physical connector)
- DVI (via the HDMI physical connector)
- HDBaseT (via the HDBaseT physical connector)
- 3G-SDI (via the SDI physical connector)
- YPbPr Component analog (via the HD VGA connector)
- RGB Analog (via the HD VGA connector).

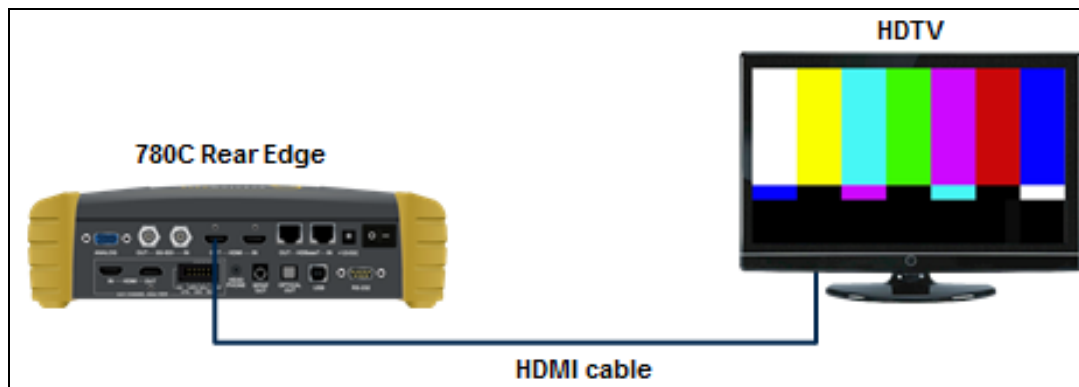
4.1 Making Physical Connections - HDMI

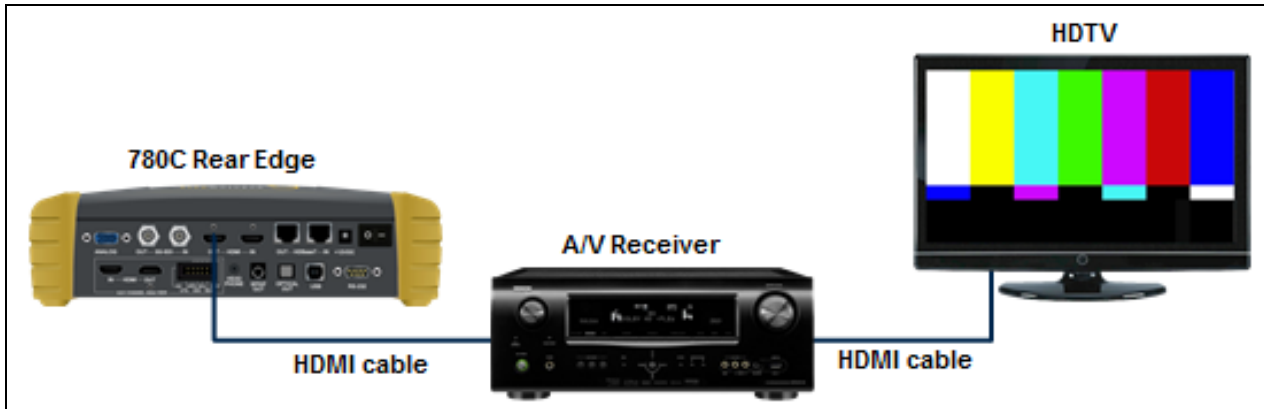
The first step in testing a sink device is to make the HDMI physical connections between the 780C and the device(s) under test.

4.1.1 Connecting the 780C to the Display Device - HDMI

Use the following procedures to make the physical connections from the 780C to the display device under test.

1. Make the cable connection between the appropriate the 780C video output connector (e.g. **HDMI OUT** or **ANALOG**) connector and the input connector of the HDTV using the cables supplied.
2. Alternatively you may connect from the 780C video output connector to an HDTV through an HDMI repeater device such as an A/V receiver. In this case make the HDMI connection between the **HDMI OUT** connector on the 780C and the HDMI input of the HDMI repeater device using an HDMI-to-HDMI cable. Then connect the HDTV to an active output on the repeater. The following illustrations depict the typical test configurations.



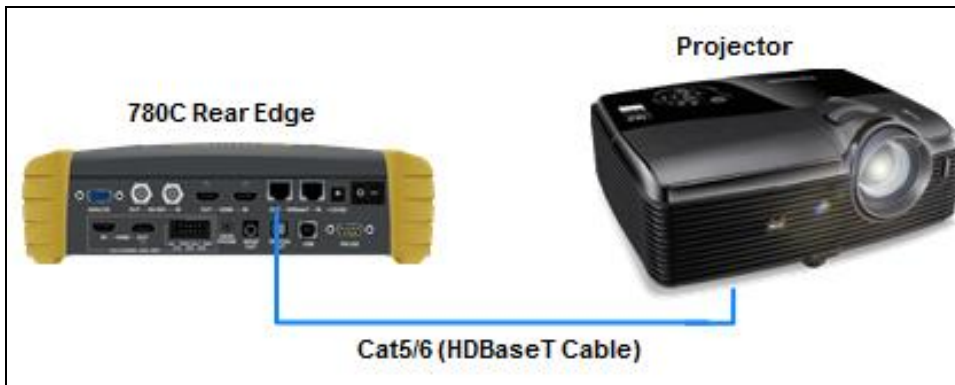


4.1.2 Connecting the 780C to the Display Device - HDBaseT

Use the following procedures to make the physical connections from the 780C to the display device under test.

1. Make the cable connection between the appropriate the 780C video HDBaseT output connector and the input connector of the HDBaseT device.

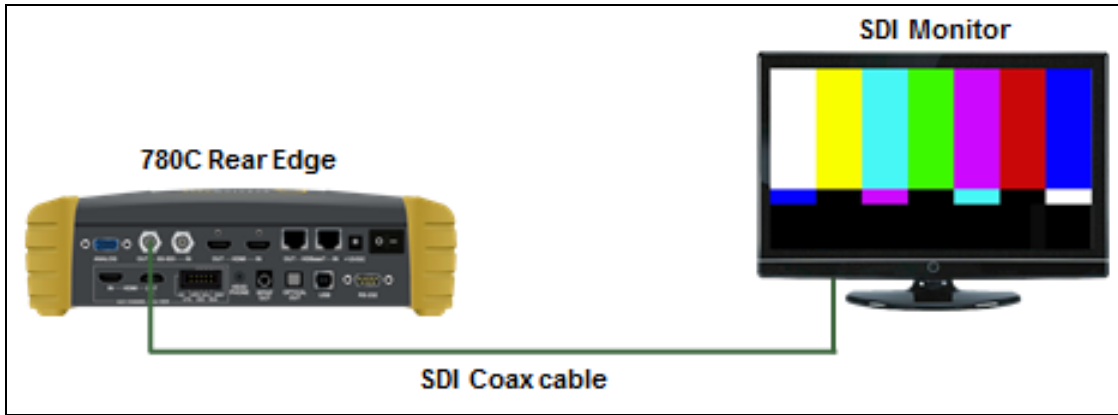
The following illustrations depict the typical test configurations.



4.1.3 Connecting the 780C to the Display Device - SDI

Use the following procedures to make the physical connections from the 780C to the display device under test.

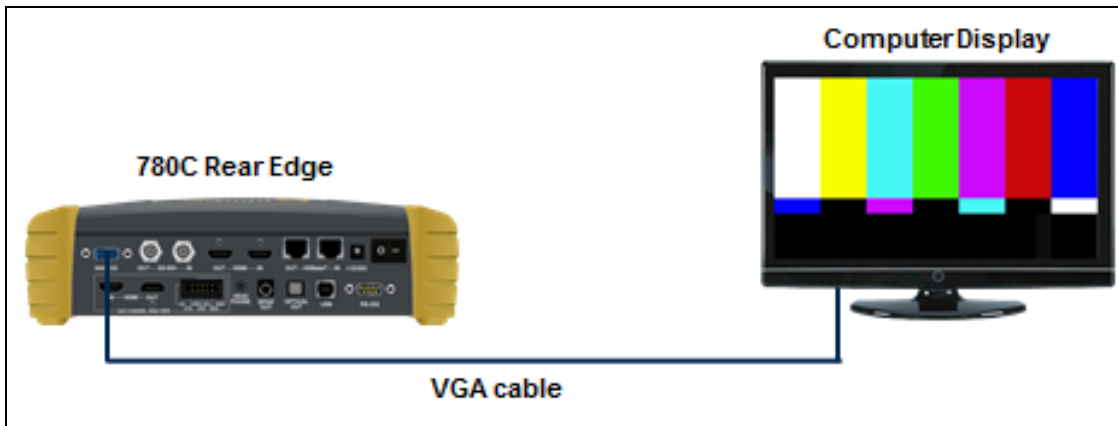
1. Make the cable connection between the appropriate the 780C video SDI output connector and the input connector of the display or monitor using the cables supplied.



4.1.4 Connecting the 780C to the Display Device - Analog

Use the following procedures to make the physical connections from the 780C to the display device under test.

1. Make the cable connection between the appropriate the 780C video VGA output connector and the input connector of the HDTV or computer monitor using the cables supplied.



4.2 Selecting a Signal Type and Resolution

After making the physical connections between the 780C and the display device under test you will need to select the signal type, Resolution and Frame Rate for the sink device under test.

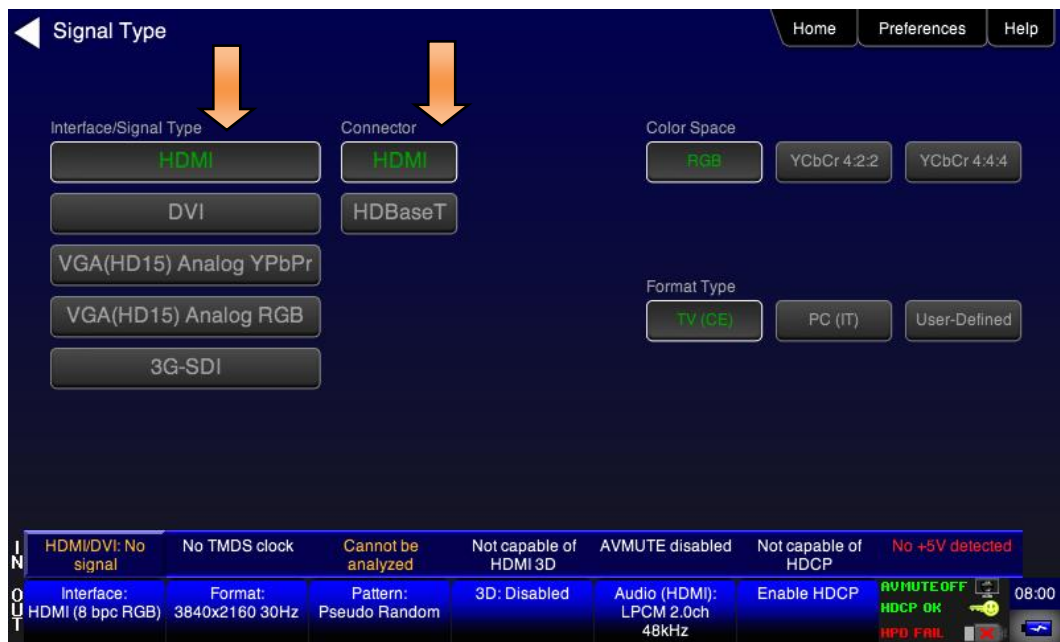
4.2.1 Procedures for Selecting a Signal Type

The procedures below describe how to select the active signal type.

1. Power up the 780C using the rocker switch on the back panel. Review the guidelines for battery usage at: [Power Considerations](#).
2. Touch select the Signal Type activation button on the OUT Status Bar (see screen example below).



The Signal Type menu appears as shown below.



3. Touch select the desired signal type using the associated activation button, example HDMI.
4. Touch select the options for the Signal Type. Use the information in Table 4-1 below as a guide:

Table 4-1: Signal Type			
Signal Type Name	Physical Connector	Option	Option Values
HDMI	HDMI OUT via HDMI to	Color Space	<ul style="list-style-type: none"> ▪ YCbCr 4:4:4, 4:2:2, 4:2:0 ▪ RGB

	HDMI cable (provided)	Bit Depth	<ul style="list-style-type: none"> ▪ 8 ▪ 10 ▪ 12
		Format Type	<ul style="list-style-type: none"> ▪ TV – Uses limited color range ▪ PC – Uses full color range ▪ User
DVI	HDMI OUT via HDMI to DVI cable (not provided)	Format Type	<ul style="list-style-type: none"> ▪ TV – Uses limited color range ▪ PC – Uses full color range ▪ User
HDBaseT	HDBaseT OUT via HDBaseT to HDBaseT cable (not provided)	Color Space	<ul style="list-style-type: none"> ▪ YCbCr 4:4:4 4:2:2, 4:2:0 ▪ RGB
		Bit Depth	<ul style="list-style-type: none"> ▪ 8 ▪ 10 ▪ 12
		Format Type	<ul style="list-style-type: none"> ▪ TV – Uses limited color range ▪ PC – Uses full color range ▪ User
3G-SDI	SDI OUT via SDI to SDI cable (not provided)	Color Space	<ul style="list-style-type: none"> ▪ YCbCr 4:2:2
		Bit Depth	<ul style="list-style-type: none"> ▪ 8
		Format Type	<ul style="list-style-type: none"> ▪ TV – Uses limited color rang
YPbPr Analog	ANALOG HD-15 (VGA) via HD to 3-RCA cable (provided)	Sync Type	<ul style="list-style-type: none"> ▪ Sep[arate] Sync ▪ Sync on Green
RGB Analog	ANALOG HD-15 (VGA) via VGA cable (not provided)	Format Type	<ul style="list-style-type: none"> ▪ TV – Uses limited color range ▪ PC – Uses full color range ▪ User
		Sync Type	<ul style="list-style-type: none"> ▪ Sep[arate] Sync ▪ Sync on Green

4.2.2 Procedures for Selecting an Resolution and Frame Rate – HDMI and HDBaseT

The procedures below describe how to select the resolution for HDMI and HDBaseT outputs.

Note: You can create your own custom formats using the Quantum Data Format Editor. These procedures are described in [Creating and Using Custom Formats, EDIDs and Bitmaps](#).

When you make a physical connection to an HDTV or monitor, a hot plug event will occur. There are two modes the 780C can be set in when testing HDMI or HDBaseT sink devices that determine how the 780C responds to this hot plug event: 1) Hot plug formats On; 2) Hot plug formats Off.

When hot plug formats are On and a hot plug event occurs, the 780C will read the EDID of the display device connected to its output port. It will then automatically configure the list available signal types (resolutions and frame rates) to only those supported by the HDMI or HDBaseT sink device. The 780C will also be configured to output the signal indicated in the EDID as the “preferred” timing. The preferred timing is highlighted in green following a hot plug event.

When hot plug formats are Off, the 780C will display all viable HDMI or HDBaseT formats for the interface whether they are supported by the display or not.

1. Select the **Preferences** from the 780C top level menu. Navigate to the second page by touch selecting the **More...** key.



2. Select the Hot Plug Formats mode to On or Off as desired. Refer to the screen above.
3. Touch select the Formats activation button on the Status bar OUT to access the Formats menu. Refer to the figure below.



The **Formats** menu appears as shown below (example HDMI):



4. Touch select the desired format and Frame Rate (example 2160p at 30Hz above).

For the HDMI formats, there are color codes that are applied to the Resolution and Frame Rate selections. The following is a summary of their meaning:

- A Resolution or Frame Rate with **white** lettering but with **no outline** – a Resolution or Frame Rate that appears in the EDID and has a short video descriptor associated with it.
- A Frame Rate with **green** lettering and with **white outline** – The Frame Rate that is currently selected.
- A Frame Rate with **red** lettering but with **no outline** – The Frame Rate is not supported by the EDID for that Resolution.
- A Frame Rate(s) with **green** lettering and with **white outline** – The Frame Rate along with the currently selected Resolution that is the “preferred” timing.

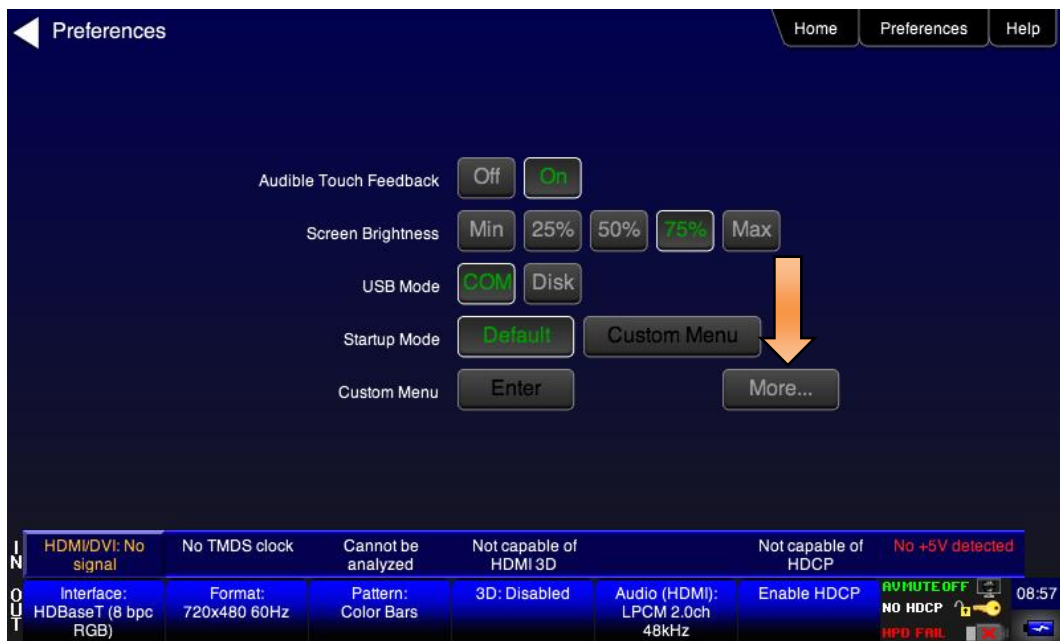
- A Frame Rate with **black** lettering but with **no outline** – The Frame Rate is not supported by the standard for the selected resolution.

Note: When you make a physical connection to an HDMI or HDBaseT HDTV or sink device, a hot plug event will occur. If **Hot Plug Formats** is enabled on the **Preference** menu, when the hot plug event occurs, the 780C will read the EDID of the display device connected to its output port. The output is automatically set to the preferred timing which is highlighted in green following a hot plug.

4.2.3 Procedures for Enabling AVMute

The procedures below describe how to enable AVMute on the HDMI or HDBaseT output ports. AVMute is an optional feature in HDMI or HDBaseT that enables a source to signal a sink to extinguish its audio and video. The source, in this case the 780C emulating a source sets the AVMute Set flag in the general control packet. The purpose of AVMute is to avoid audio artifacts when switching resolutions.

1. Select the **Preferences** from the 780C top level menu. Navigate to the second page by touch selecting the **More...** key.



2. Touch select the On activation button next to AVMute on the screen below.



4.2.4 Procedures for Selecting a Resolution and Frame Rate – SDI

The procedures below describe how to select the resolution for the SDI output.

Note: You can create your own custom formats using the Quantum Data Format Editor. These procedures are described in [Creating and Using Custom Formats, EDIDs and Bitmaps](#).

1. Touch select the Formats activation button on the Status bar OUT to access the Formats menu. Refer to the figure below.



The **Formats** menu appears as shown below:



2. Touch select the desired format and Frame Rate (example 2160p at 30Hz above).

4.3 Rendering Test Patterns on an HDTV

This subsection describes how to render test patterns on an HDTV. You will first have to complete the previous procedures:

- [Making the physical connections](#)
- [Selecting the Signal Type and Resolution](#)

4.3.1 Procedures for Outputting Test Patterns

The procedures below cover cases where there is a direct connection between the 780C and the HDTV and also where the 780C is connected to an HDTV through a repeater device.

1. From the **Home** screen on the 780C display, touch select the **Video Pattern** status and activation button on the Status Bar as shown below.



2. Touch select the desired test pattern from the menu shown below. You can select patterns that are standard with the 780C or bitmaps that you have imported.

Note: A “+” on the lower right portion of the pattern indicates that there are options related to the specific pattern. In these cases you double touch select to access the lower level menu.



3. (If applicable) Specify the test pattern options. Use the information in Table 4-3 below as a guide.

Note: There may be additional patterns not shown in the table.

Pattern Name	Variant	Options	Range of Values
--------------	---------	---------	-----------------

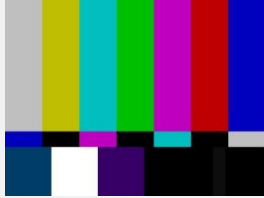
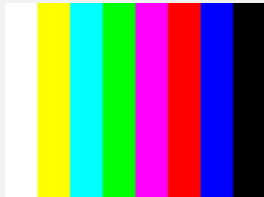
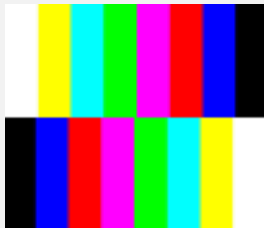
Table 4-3: Test Patterns			
Pattern Name	Variant	Options	Range of Values
<p>ColorBar patterns</p> <p>Applications:</p> <p>SMPTEBars - To adjust color and hue.</p> <p>Colorbars - To test a display's ability to produce fully saturated primary and secondary color.</p>	<p>SMPTE</p> 	Orientation - Vertical	Direction: <ul style="list-style-type: none"> Left to Right Right to Left
		Orientation - Horizontal	Direction: <ul style="list-style-type: none"> Top / Bottom Bottom / Top
		Pixel values in RGB, 8bit with TV (limited range) mode. Note 1: Deep color values for 10-bit or 12-bit are different from those shown. Note 2: When using PC Format type the range will go from 0 to 255 for 8-bit color mode.	From left to right; top to bottom: Top bars: R=180 G=180 B=180 R=180 G=180 B=16 R=16 G=180 B=180 R=16 G=180 B=16 R=180 G=16 B=180 R=180 G=16 B=16 R=16 G=16 B=180 R=16 G=16 B=180 Middle short bars: R=16 G=16 B=180 R=16 G=16 B=16 R=180 G=16 B=180 R=16 G=16 B=16 R=16 G=180 B=180 R=16 G=16 B=16 R=180 G=180 B=180 Lower bars: R=18 G=70 B=107 R=235 G=235 B=235 R=86 G=31 B=134 R=16 G=16 B=16 R=9 G=9 B=9 R=16 G=16 B=16 R=23 G=23 B=23
	<p>Full</p> 	Orientation - Vertical	Direction: <ul style="list-style-type: none"> Left to Right Right to Left
		Orientation - Horizontal	Direction: <ul style="list-style-type: none"> Top / Bottom Bottom / Top
	<p>Split</p> 	Orientation - Vertical	Direction: <ul style="list-style-type: none"> Left to Right Right to Left
Orientation - Horizontal		Direction: <ul style="list-style-type: none"> Top / Bottom Bottom / Top 	

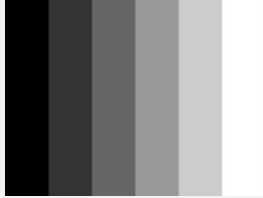

Table 4-3: Test Patterns			
Pattern Name	Variant	Options	Range of Values
<p>Ramp/Stair Patterns</p> <p>Applications:</p> <p>Stair - To visually check grayscale tracking performance of a rear projection display.</p> <p>Ramp – To check the digitizing linearity of video signal processors.</p>	<p>Stair - Full</p> 	Orientation - Vertical	Direction: <ul style="list-style-type: none"> ▪ Left to Right ▪ Right to Left
		Orientation - Horizontal	Direction: <ul style="list-style-type: none"> ▪ Top / Bottom ▪ Bottom / Top
		Bars	<ul style="list-style-type: none"> ▪ 5 ▪ 11 ▪ 21
		Color	<ul style="list-style-type: none"> ▪ R ▪ G ▪ B ▪ C ▪ M ▪ Y ▪ W
	<p>Stair – Split</p> 	Orientation - Vertical	Direction: <ul style="list-style-type: none"> ▪ Left to Right ▪ Right to Left
		Orientation - Horizontal	Direction: <ul style="list-style-type: none"> ▪ Top / Bottom ▪ Bottom / Top
		Bars	<ul style="list-style-type: none"> ▪ 5 ▪ 11 ▪ 21
		Color	<ul style="list-style-type: none"> ▪ R ▪ G ▪ B ▪ C ▪ M ▪ Y ▪ W
	Ramp	Color	<ul style="list-style-type: none"> ▪ R ▪ G ▪ B ▪ C ▪ M ▪ Y ▪ W

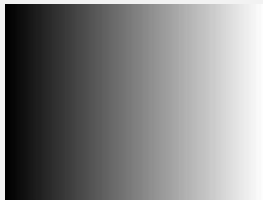


Table 4-3: Test Patterns			
Pattern Name	Variant	Options	Range of Values
		Pixel values in RGB, 8bit with TV (limited range) mode. Note 1: When using PC Format type the range will go from 0 to 255 for 8-bit color mode.	In 8-bit color mode (24) the ramp displays all 256 shades of gray. In 10-bit color mode (30) the ramp displays 256 shades of gray throughout a range of 64 – 940 skipping interim shades at each increment. In 12-bit color mode (36) the ramp displays 256 shades of gray throughout a range of 256 – 3760 skipping interim shades at each increment.
3D Box Pattern Application: This is a 3D pattern used to test 3D displays. The pattern enables you to set the offset between the left and right image components.	No variants 	Box 1 Offset	-64 to +64
		Box 2 Offset	-64 to +64
		Background Brightness	0 to 63
3D Color Ramp Application: This is a 3D pattern used to test 3D color uniformity and crosstalk or extinction ratio.	No variants 	Description: There are 4 pairs of horizontal color bars. Each bar depicts a color gradation from red to purple; two from left to right and one from right to left. Method – Color uniformity: <ol style="list-style-type: none"> 1. Close left eye to view image from right eye. 2. Assess the color gradation on each bar. 3. Close right eye to view image from left eye. 4. Subjectively compare the images to assess color uniformity. Method – Crosstalk (extinction ratio): <ol style="list-style-type: none"> 1. Close left eye to view image from right eye. 2. Verify that the bottom bar is extinguished. The extent to which the bar is not extinguished represents the amount of crosstalk. 3. Repeat for a test of the left eye 	

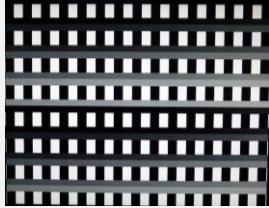
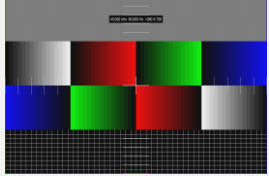
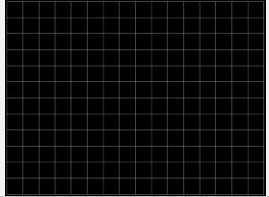
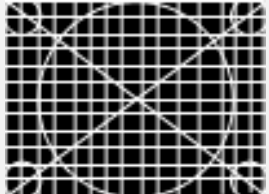
Table 4-3: Test Patterns			
Pattern Name	Variant	Options	Range of Values
<p>3D Cross Talk</p> <p>Application: This is a 3D pattern used to measure the crosstalk (extinction ratio) for frame packing, top and bottom and side by side 3D format structures.</p>	<p>No variants</p> 	<p>Description: This image is divided in two sections with four rows of 16 white boxes each. The top section is for testing with the left eye open. The bottom section is for testing with the right eye open. The background area surrounding the boxes is a series of grayscale ramps. The ramps begin at 100 IRE and transitions to 50 IRE at the left end of the fourth row of each series.</p> <p>Method – Calculating percent crosstalk:</p> <ol style="list-style-type: none"> 1. Close right eye to test the left eye using the top section. 2. Check the visibility of the boxes. Any deviation from black indicates crosstalk. 3. Assess where the box and its background blend such that they are not distinguishable. 4. Calculate the degree of crosstalk as a percent by counting the number of boxes (from the beginning of the series to the box identified in step 3) and divide that by 127. Example if the 20th box blends with its background, the crosstalk would be $20/127 * 100 = 15.7\%$ 5. Repeat with the left eye closed to test the right eye. 	
<p>PGCWRGB Pattern</p> <p>Application: This is a scrolling pattern used to test for noise on analog displays and motion artifacts.</p>	<p>No variants</p> 	<p>Show Text</p> <p>Show Center Cross</p> <p>Show Video</p> <p>Show Overscan</p> <p>Grid Type</p>	<p>On / Off</p> <p>On / Off</p> <p>On / Off</p> <p>On / Off</p> <ul style="list-style-type: none"> • 10x50 • 5% H/V
<p>Geometry/Resolution Patterns</p> <p>Applications:</p> <p>Grid – To check and adjust convergence of red, green and blue pictures.</p> <p>Linearity – for testing deflection linearity testing and alignment.</p> <p>Overscan – To check and adjust for the proper geometry of display including picture centering, size, pincushion and linearity.</p>	<p>Grid</p>  <p>Linearity</p> 	<p>Color Mode</p> <p>Color Mode</p>	<ul style="list-style-type: none"> ▪ White on Black ▪ Black on White <ul style="list-style-type: none"> ▪ White on Black ▪ Black on White

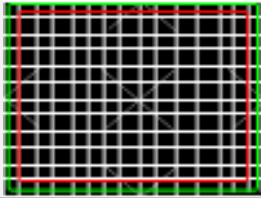
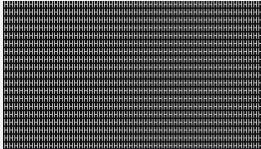
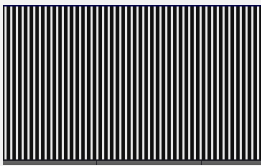
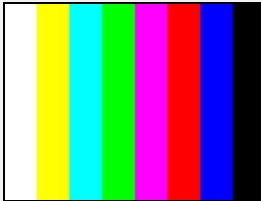
Table 4-3: Test Patterns			
Pattern Name	Variant	Options	Range of Values
	Overscan 	N/A	
EMI/Grill Applications: EMI – Show grid of “H” characters to check for EMI effects on image. Each “H” character should be clear and distinct.	EMI 	H Type	
		Grill On/Off	
		Scroll – Scrolls the “H” characters vertically.	
Grill – for verifying monitor resolution.	EMI - Grill 	Grill On/Off	
		Grill Mode	
Color Bars – To test a display's ability to produce fully saturated primary and secondary color.	EMI - ColorBars 	Scroll – color bars scroll horizontally.	

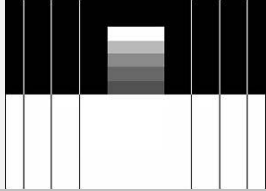



Table 4-3: Test Patterns			
Pattern Name	Variant	Options	Range of Values
<p>Needles Pattern</p> <p>Application: To detect whether scan velocity modulation is enabled on display.</p>	<p>No variants</p> 		
<p>Window/Raster Pattern</p> <p>Applications:</p> <p>Window1 - To calibrate display drive chromaticity.</p> <p>Window2 - To calibrate display cutoff chromaticity.</p> <p>Raster – To check color purity and display chrominance uniformity.</p>	<p>Window</p> 	<p>IRE Level</p>	<ul style="list-style-type: none"> ▪ -5 ▪ -1 ▪ 100 ▪ +1 ▪ +5
		<p>IRE Label</p>	<ul style="list-style-type: none"> ▪ Off ▪ On
		<p>Color</p>	<ul style="list-style-type: none"> ▪ R ▪ G ▪ B ▪ C ▪ M ▪ Y ▪ W
	<p>Raster</p> 	<p>IRE Level</p>	<ul style="list-style-type: none"> ▪ -5 ▪ -1 ▪ 100 ▪ +1 ▪ +5
		<p>IRE Label</p>	<ul style="list-style-type: none"> ▪ Off ▪ On
		<p>Color</p>	<ul style="list-style-type: none"> ▪ R ▪ G ▪ B ▪ C ▪ M ▪ Y ▪ W
<p>Needles Pattern</p> <p>Application: To detect whether scan velocity modulation is enabled on display.</p>	<p>N/A</p> 		


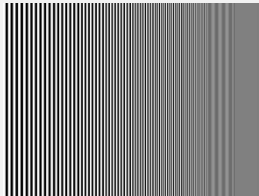
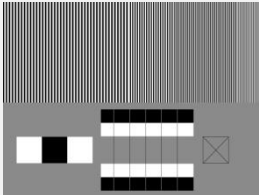
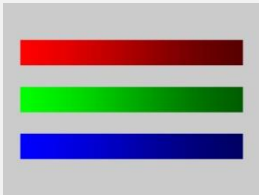

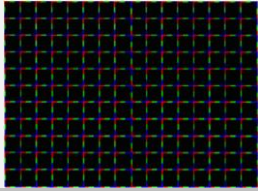
Table 4-3: Test Patterns			
Pattern Name	Variant	Options	Range of Values
<p>Focus Pattern</p> <p>Application: To detect whether scan velocity modulation is enabled on display.</p>	<p>N/A</p> 		
<p>Multiburst Pattern</p> <p>Application: To check a display's ability to produce sharply defined stripes at equal brightness up to full resolution.</p>	<p>N/A</p> 		
<p>Sharpness</p> <p>Application: To align display sharpness, picture, aperture and scan velocity modulation adjustments.</p>	<p>No Variants</p> 		
<p>Decoder Check</p> <p>Application: To check the color decoder performance to determine if the decoder over-emphasizes red or green colors.</p>	<p>No Variants</p> 		
<p>Decoder Adjust Pattern</p> <p>Application: To adjust a display's color decoder/matrix circuit for most accurate color reproduction.</p>	<p>No Variants</p> 		
<p>Converge Pattern</p> <p>Application: To color converge a display throughout the entire picture area.</p>	<p>No Variants</p> 		

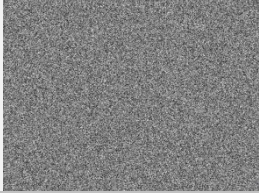
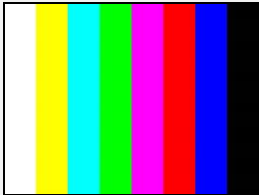

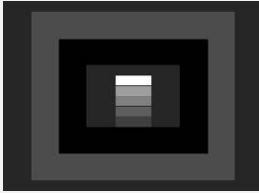
Table 4-3: Test Patterns			
Pattern Name	Variant	Options	Range of Values
<p>Pseudo Random Pattern</p> <p>Application: To test for pixel errors on an HDMI cable.</p>	<p>No Variants</p> 		
<p>LG Color Pattern</p> <p>Application: To test a display's ability to produce fully saturated primary and secondary color.</p> <p>White is 100 IRE Yellow is 100 IRE Cyan is 100 IRE Gray is 35 IRE Red is 100 IRE Blue is 100 IRE Black is 0 IRE</p>	<p>No Variants</p> 	Horizontal	
		Vertical	
<p>UL 3 Bar Pattern</p>	<p>No Variants</p> 		
<p>Black Pluge Pattern</p> <p>Application: To set the picture black level and check the DC restoration performance of a display. Note: Outer boxes blink once per second.</p>	<p>No Variants</p> 	<p>Pixel values in RGB, 8bit with limited range (TV) mode.</p>	<p>Outer background: R=16 G=16 B=16 Outer blinking box: R=20/16 G=20/16 B=20/16 Inner blinking box: R=9/16 G=9/16 B=9/16 Top most stair value: R=235 G=235 B=235 Second stair value: R=180 G=180 B=180 Third stair value: R=140 G=140 B=140 Fourth stair value: R=112 G=112 B=112 Bottom stair value: R=90 G=90 B=90</p>

Table 4-3: Test Patterns			
Pattern Name	Variant	Options	Range of Values
		Pixel values in RGB, 10bit with limited range (TV) mode.	Outer background: R=64 G=64 B=64 Outer blinking box: R=80/64 G=80/64 B=80/64 Inner blinking box: R=36/64 G=36/64 B=36/64 Top most stair value: R=940 G=940 B=940 Second stair value: R=720 G=720 B=720 Third stair value: R=560 G=560 B=560 Fourth stair value: R=448 G=448 B=448 Bottom stair value: R=360 G=360 B=360
		Pixel values in RGB, 12bit with limited range (TV) mode.	Outer background: R=256 G=256 B=256 Outer blinking box: R=320/256 G=320/256 B=320/256 Inner blinking box: R=144/256 G=144/256 B=144/256 Top most stair value: R=3760 G=3760 B=3760 Second stair value: R=2880 G=2880 B=2880 Third stair value: R=2240 G=2240 B=2240 Fourth stair value: R=1792 G=1792 B=1792 Bottom stair value: R=1440 G=1440 B=1440
<p>White Pluge Pattern</p> <p>Application: To set the contrast and brightness controls on fixed pixel displays.</p>	<p>No Variants</p> 	Pixel values in RGB, 8bit with limited range (TV) mode.	<p>Top background: R=16 G=16 B=16 Top dark vertical line: R=8 G=8 B=8 Top larger (outer) box: R=18 G=18 B=18 Top smaller (inner) box: R=20 G=20 B=20</p> <p>Bottom background: R=235 G=235 B=235 Bottom larger (outer) box: R=232 G=232 B=232 Bottom smaller (inner) box: R=230 G=230 B=230</p>

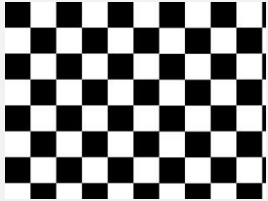
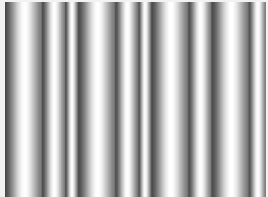
Table 4-3: Test Patterns			
Pattern Name	Variant	Options	Range of Values
		Pixel values in RGB, 10bit with limited range (TV) mode.	Top background: R=64 G=64 B=64 Top dark vertical line: R=32 G=32 B=32 Top larger (outer) box: R=72 G=72 B=72 Top smaller (inner) box: R=80 G=80 B=80 Bottom background: R=940 G=940 B=940 Bottom larger (outer) box: R=928 G=928 B=928 Bottom smaller (inner) box: R=920 G=920 B=920
		Pixel values in RGB, 12bit with limited range (TV) mode.	Top background: R=256 G=256 B=256 Top dark vertical line: R=128 G=128 B=128 Top larger (outer) box: R=288 G=288 B=288 Top smaller (inner) box: R=320 G=320 B=320 Bottom background: R=3760 G=3760 B=3760 Bottom larger (outer) box: R=3712 G=3712 B=3712 Bottom smaller (inner) box: R=3680 G=3680 B=3680
Checkboard Pattern Application: To check the regulation of CRT video drive power supply circuits.	No Variants 	Rows	<ul style="list-style-type: none"> ▪ 2 ▪ 3 ▪ 4 ▪ 5 ▪ 6
		Columns	<ul style="list-style-type: none"> ▪ 2 ▪ 3 ▪ 4 ▪ 5 ▪ 6
Zone Plate Pattern This is a bitmap that can be scrolled to test motion artifacts. You can replace particular bitmap with any other bitmap image to allow scrolling. You just need to ensure that you	Vertical 	Vertical Movement	<ul style="list-style-type: none"> ▪ Stop ▪ Slow ▪ Medium ▪ Fast

Table 4-3: Test Patterns			
Pattern Name	Variant	Options	Range of Values
assign it the same name.		Horizontal Movement	<ul style="list-style-type: none"> ▪ Stop ▪ Slow ▪ Medium ▪ Fast

4.4 Using Custom Test Image Packs

The 780C provides licensed image packs for certain sets of test images. You need to have a license key to use these custom test image packs. You can arrange to get access to them by contacting Quantum Data customer support at: <http://www.quantumdata.com/support>.

Note: The custom test image packs are bitmap images. Bitmap images are RGB and will not display properly on the 3G-SDI output.

When you purchase an image pack it appears as an icon at the end of the list of Test Patterns. A sample screen is shown below (Philips1, ChinaRes, Master). You simply select one of the test patterns (e.g. ChinaRes in the screen example below). They will take a few seconds to load. They will load at the resolution of the format that you have selected.



Refer to the tables below for a description and depiction of the Image Packs currently offered.

Table 4-4: Custom Test Image Packs – ChinaRes Pattern

ChinaRes Pattern Pack

This is a bitmap that is available through the Image Packs option. The ChinaRes test pattern is specified by the National Testing and Inspection Center for Radio and TV Products of China.

The image pack includes both a standard definition aspect ratio (shown right) and a high definition aspect ratio. This test pattern is supported at: 1920x1080, 1280x720, 720x576 and 720x480 resolutions.

The following is a description of the elements in this test image

1. Overscan gauges to determine percentage of overscan.
2. Centered cross, centered circles, and centered grid to test centering and concentricity.
3. White grid to test convergence.
4. Central resolution wedge gauges for vertical, horizontal, and diagonal resolutions.
5. Corner resolution wedge gauges for vertical and horizontal resolutions.
6. 4-quadrant horizontal and vertical test areas to judge resolution and display artifacts.
7. Color bar for testing color purity and chroma delay.
8. 10-step grayscale to test brightness, contrast, and luminance.
9. Split (left and right) grayscales for testing dark-field and bright-field gray levels.

- Average picture level is approximately 50%.

Table 4-5: Custom Test Image Packs – THX Test Patterns

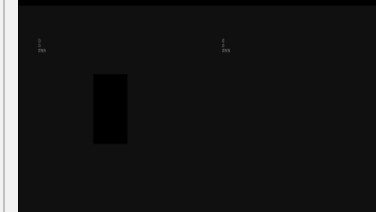
Table 4-5: Custom Test Image Packs – THX Test Patterns

THX Test Patterns
The THX Pattern Pack offers a variety of test patterns for calibrating the luminance and chrominance of high end 3D-capable HDTVs. The following is a list of test patterns provided in this optional test pattern package.

3D Convergence - test patterns to align pixels for proper convergence.



3D Crosstalk – test patterns to determine level of 3D crosstalk.



Color Gamut – 2D/3D primary and secondary color patterns to fine-tune colors and gamma.



Picture performance – pattern within THX Optimizer to verify accuracy of skin tones.



THX Optimizer - test patterns to easily adjust brightness, contrast, color, tint, etc.



1. Uniformity - 2D/3D circle patterns to determine luminance and chrominance screen uniformity.

Table 4-5: Custom Test Image Packs – THX Test Patterns

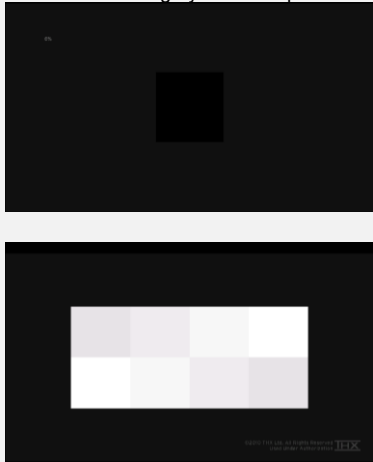


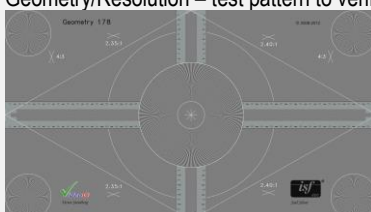

	<p>THX box - 2D/3D grayscale test patterns to accurately adjust white point and gamma.</p>  <p>The image displays two grayscale test patterns. The top pattern is a black square with a smaller white square centered within it. The bottom pattern is a 2x2 grid of four squares, each with a different grayscale value, ranging from white to black. The text 'THX' is visible in the bottom right corner of the second pattern.</p>
--	--

Table 4-6: Custom Test Image Packs – ISF® Test Patterns

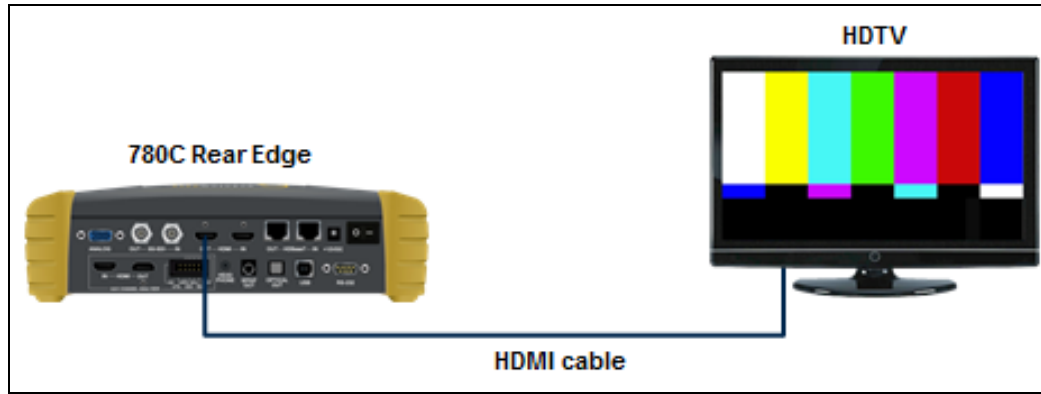
<p>ISF Test Patterns</p> <p>The ISF Pattern Pack offers patterns for verifying white and black levels as well as geometry and resolution for calibrating high end HDTVs</p>	<p>Black Pluge - for calibrating black level for dynamic range.</p>  <p>White Pluge - for calibrating white level for dynamic range.</p>  <p>Geometry/Resolution – test pattern to verify geometry and resolution.</p>  <p>Red-Blue Color Multiburst – test pattern for verifying chroma resolution for red and blue transitions.</p> 
--	---

4.5 Outputting 3D Test Patterns through HDMI or HDBaseT

This subsection describes how to render 3D test patterns on an HDTV. The 780C supports Side-by-Side, Top-and-Bottom and Frame Packing (for both interlaced and progressive timings) 3D format structures.

4.5.1 Configurations for Rendering 3D Bitmaps on an HDMI or HDBaseT Sink Device

Typically you will render 3D bitmap images with the 780C directly connected to an HDTV or projector. This configuration is shown below:



4.5.2 Procedures for Obtaining 3D Bitmaps on HDMI or HDBaseT Sink Device

Use the procedures below to render 3D bitmap images on an HDMI sink.

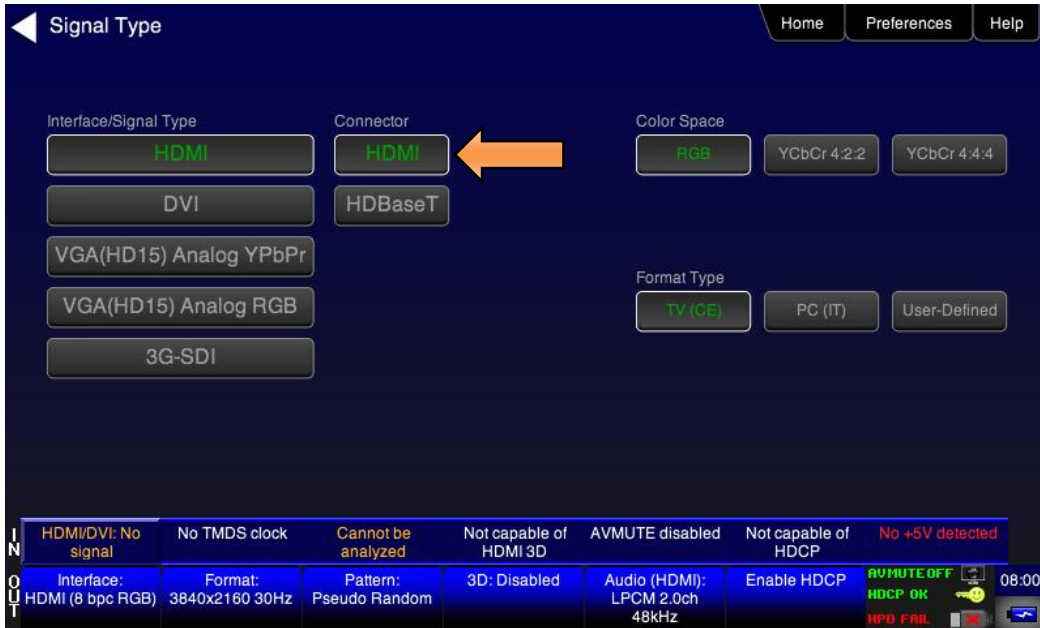
1. Follow the procedures provided above to enable the HDMI output as the Signal Type.
2. Obtain 3D bitmaps. You can obtain 3D bitmaps in three ways:
 - Develop your own 3D bitmaps.
 - Sample 3D bitmaps from the Quantum Data website (www.quantumdata.com/downloads).
 - Generate 3D bitmaps from your own stereoscopic image pairs using the Quantum Data 3D Bitmap Conversion Tool available from the Quantum Data website (www.quantumdata.com/downloads).
3. Transfer your 3D bitmaps over to the 780C using the procedures described in [Importing Custom Bitmaps](#).

4.5.3 Procedures for Rendering 3D Bitmaps or 3D Test Patterns on HDMI or HDBaseT Sink Device

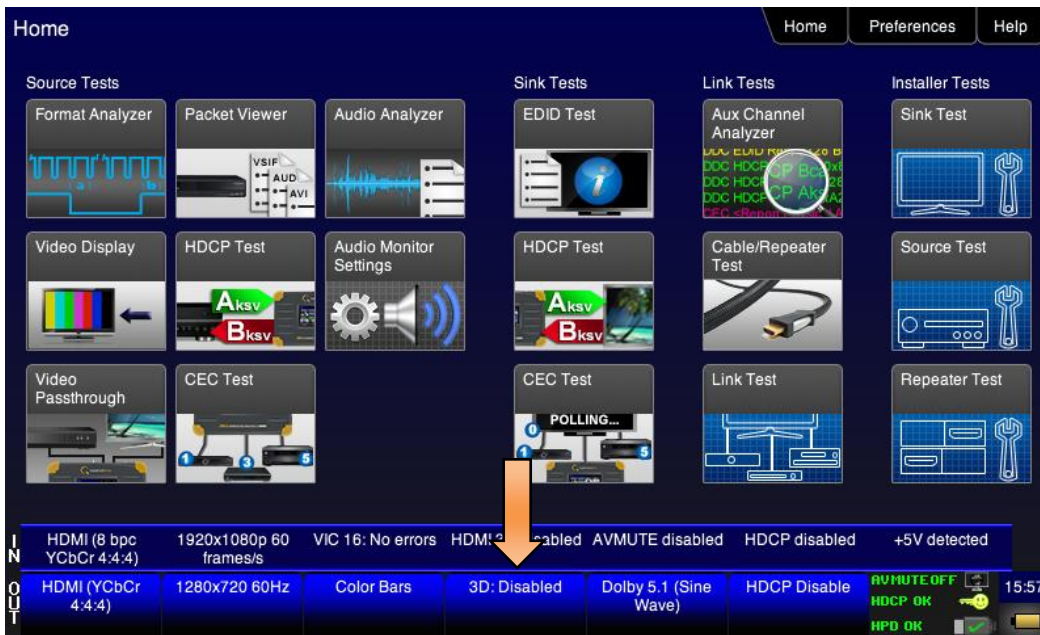
1. Select a format that is suitable for rendering 3D images such as 720p60 and 1080. Use the procedures above [Procedures for Selecting an HDMI Resolution and Frame Rate](#).

If you have used the Quantum Data 3D Bitmap Conversion Tool, there is a naming convention for the 3D bitmaps which also provides the required format for each specific bitmap.

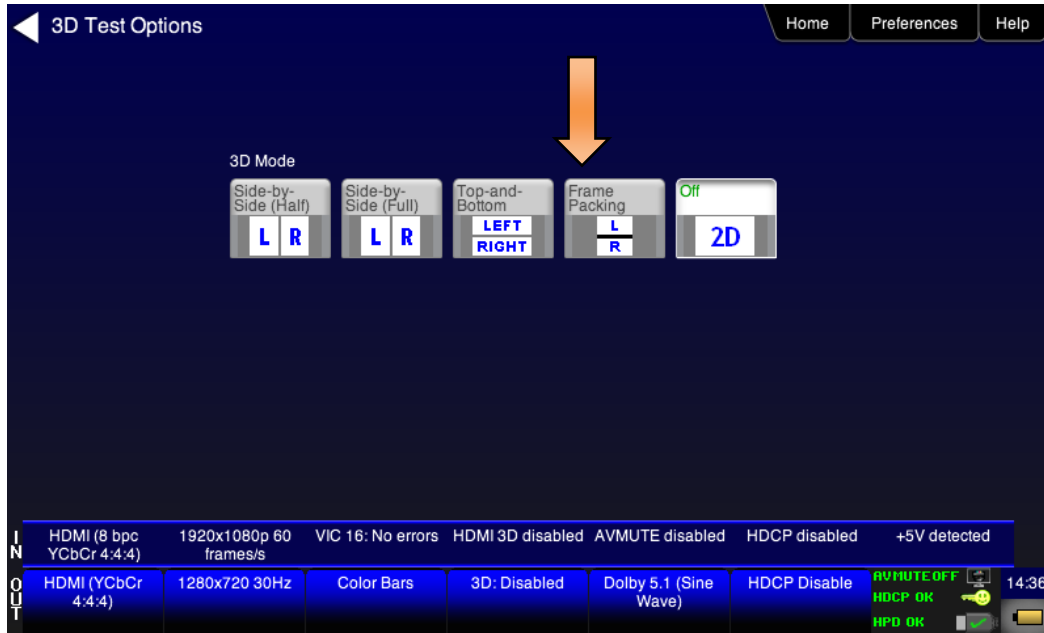
2. Enable the HDMI or HDBaseT as the active digital interface input.



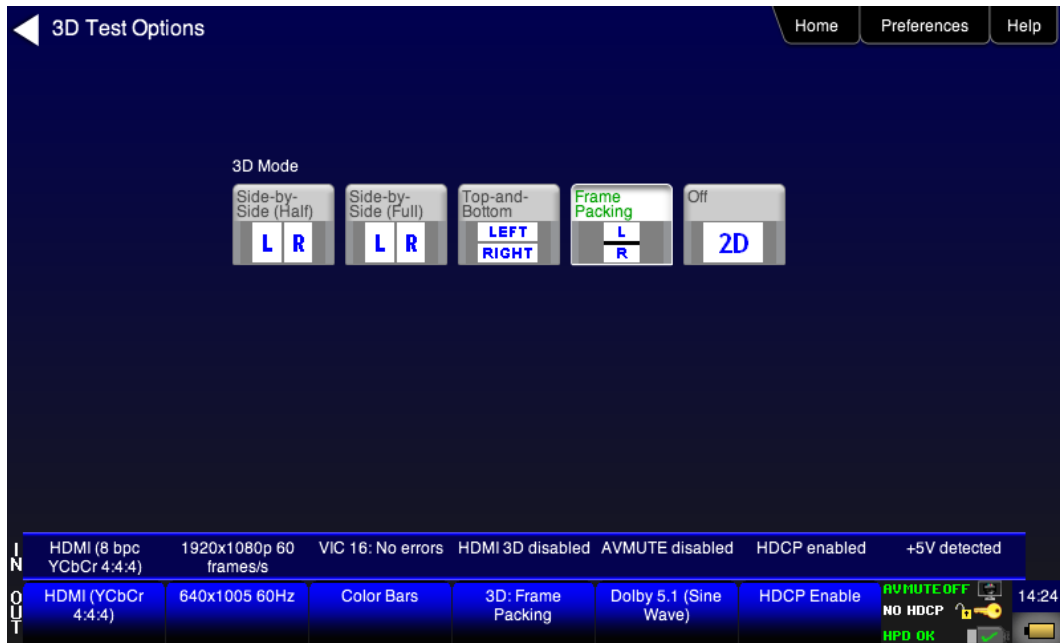
3. Touch select **3D Output** option from the top level menu shown below.



The following screen will appear:



4. Select the 3D mode (Side-by-Side, Top-and-Bottom or Frame Packing) and then select the subtype and Left/Right options (if applicable).



5. Select the 3D bitmap or image image from the Test Pattern list.



Note: If you are using one of the 3D bitmaps (as opposed to a standard 3D test pattern) you will have to make sure that the 3D bitmap you use matches your selection of 3D formats and timing (resolution). In the example above, a 3D Frame Packing bitmap is selected for 1280 x 720. Therefore you have to make sure that you select that specific timing (i.e. 1280 x 720) and that specific 3D format structure (Frame Packing).

4.6 How to Scroll or Pan a Bitmap Pattern

This subsection describes how to scroll bitmaps on your 780C.

Note: The bitmap images are RGB and will not display properly on the 3G-SDI output.

4.6.1 Guidelines for Scrolling Bitmaps

There are two ways you can animate (move) a bitmap image: 1) image shifting (scrolling); 2) panning. You can shift or scroll a bitmap image that you have imported into the 780C by modifying the X and Y parameters or by dragging and panning. When you use the X and Y parameters, you are limited to linear scrolling. With panning you can move the image in non-linear motions.

You can only scroll bitmaps whose overall pixel resolution is smaller than the resolution of the active format and you can only scroll them within the bounds of the resolution of the active format. You cannot scroll the standard test patterns in the 780C.

In order to scroll a bitmap the name of the **bitmap has to be “zp.bmp.”** But you can scroll any bitmap. You just have to make sure that you have named it “zp.bmp” (without the quotes). The zone plate bitmap is the only bitmap that comes standard with the 780C.

4.6.2 Procedures for Scrolling Bitmaps

Use the following procedure to scroll your bitmaps.

1. Touch select the desired bitmap image, e.g. Zone Plate image from the list of video patterns.



2. Double touch select on the Zone Plate bitmap to access its options.

The **Zone Plate Options** menu appears:



3. Specify the **Horizontal Movement** by touch selecting the appropriate setting **Slow**, **Medium**, **Fast**.

4. Specify the **Vertical Movement** by touch selecting the appropriate setting **Slow**, **Medium**, **Fast**.

The pattern will begin to move around the raster of the display in accordance with the horizontal and vertical settings. To halt the motion, touch **Stop** for either or both of the **Horizontal Movement** and **Vertical Movement**.

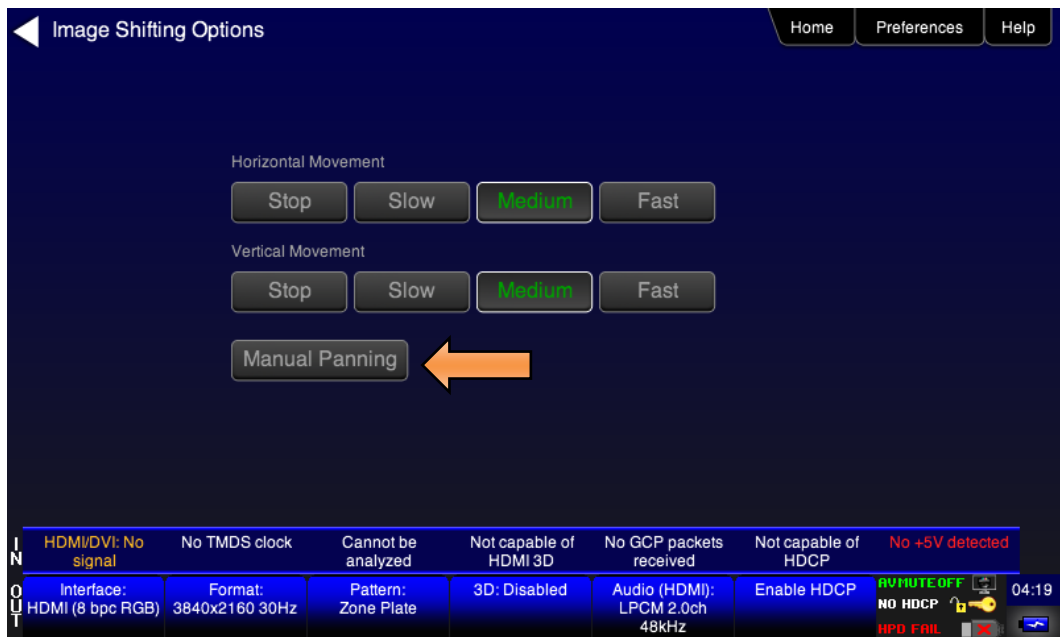
4.6.3 Procedures for Panning Bitmaps

Use the following procedure to pan your custom bitmaps.

1. Select by double touching, the desired bitmap image, e.g. Master 1920x1080 image from the list of video patterns (shown below).



2. Double touch select on a bitmap to access its options. The screen below appears.



3. Select Manual Panning to initiate the panning operation. The message shown on the screen below will appear.
4. Simply move your finger or stylus around the screen to pan the image.



4.7 Testing Digital Audio on an HDTV or A/V Receiver

This section provides procedures for testing digital audio on an HDTV or A/V Receiver.

Note: It is recommended not to select bitmap images when outputting compressed audio clips.

Table 4-5 below summarizes the 780C support for digital audio.

Table 4-5: Summary of Audio Signal Types		
Audio Signal Type	Interfaces	Description
Dolby 5.1	<ul style="list-style-type: none"> ▪ HDMI ▪ HDBaseT ▪ SDI ▪ Optical ▪ SPDIF ▪ HDMI ARC (780C only) 	Provides a set of Dolby Digital 5.1 noise patterns: <ul style="list-style-type: none"> ▪ 500-2kHz Pink ▪ 20-20kHz Pink ▪ Sine Wave ▪ Impulse ▪ Polarity ▪ Auto Time Delay
Dolby Digital Plus 7.1	<ul style="list-style-type: none"> ▪ HDMI ▪ HDBaseT ▪ SDI 	Provides a set of Dolby Digital Plus 7.1 sine wave clips: <ul style="list-style-type: none"> ▪ 2.0 192kHz – 2 channel @ 192kHz sampling rate ▪ 5.1 192kHz – 6 channel @ 192kHz sampling rate ▪ 7.1 192kHz – 8 channel @ 192kHz sampling rate
DTS-ES 6.1	<ul style="list-style-type: none"> ▪ HDMI ▪ HDBaseT ▪ SDI ▪ Optical ▪ SPDIF ▪ HDMI ARC (780C only) 	Provides a set of DTS ES 6.1 noise pattern clips: <ul style="list-style-type: none"> ▪ 500-2kHz Pink ▪ 20-20kHz Pink ▪ Sine Wave ▪ Impulse ▪ Polarity ▪ Auto Time Delay
Dolby TrueHD	<ul style="list-style-type: none"> ▪ HDMI ▪ HDBaseT 	Provides a set of Dolby TrueHD Hi Bit Rate sine wave clips: <ul style="list-style-type: none"> ▪ 192kHz 7.1 1kHz TrueHD – 8 channel @ 192kHz sampling rate ▪ 192kHz 7.1 2kHz TrueHD – 2 channel @ 192kHz sampling rate
DTS HD Master Audio	<ul style="list-style-type: none"> ▪ HDMI ▪ HDBaseT 	Provides a set of DTS-HD Hi Bit Rate sine wave clips: <ul style="list-style-type: none"> ▪ 192kHz 7.1 HDMA – 8 channel @ 192kHz sampling rate ▪ 192kHz 5.1 HDMA – 6 channel @ 192kHz sampling rate
PCM Sine Wave (programmable)	<ul style="list-style-type: none"> ▪ HDMI ▪ HDBaseT ▪ SDI ▪ Optical ▪ SPDIF ▪ HDMI ARC 	Provides programmable sine waves: <ul style="list-style-type: none"> ▪ Bits per sample – 16, 20, 24 ▪ Sampling rate (kHz) – 32, 44.2, 48, 88.2, 96, 176.4, 192 ▪ Channels – 2.0, 2.1, 5.1, 6.1, 7.1 ▪ Level – 0dB to -99dB in 1dB or 3dB increments (per channel) ▪ Frequency – 0.01kHz to 20kHz in 1Hz, 10Hz, 100Hz or 1000Hz increments (per channel) ▪ Mute – On/Off (per channel)

4.7.1 Connecting the 780C to an Audio Rendering Device

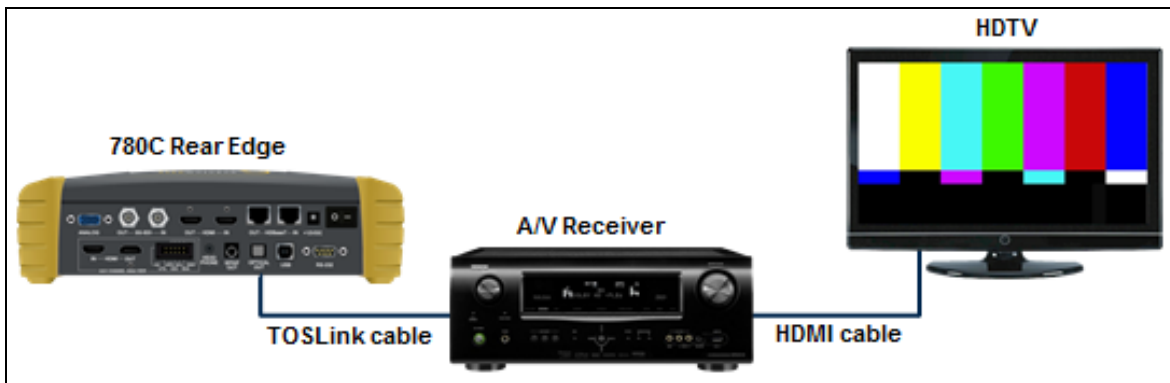
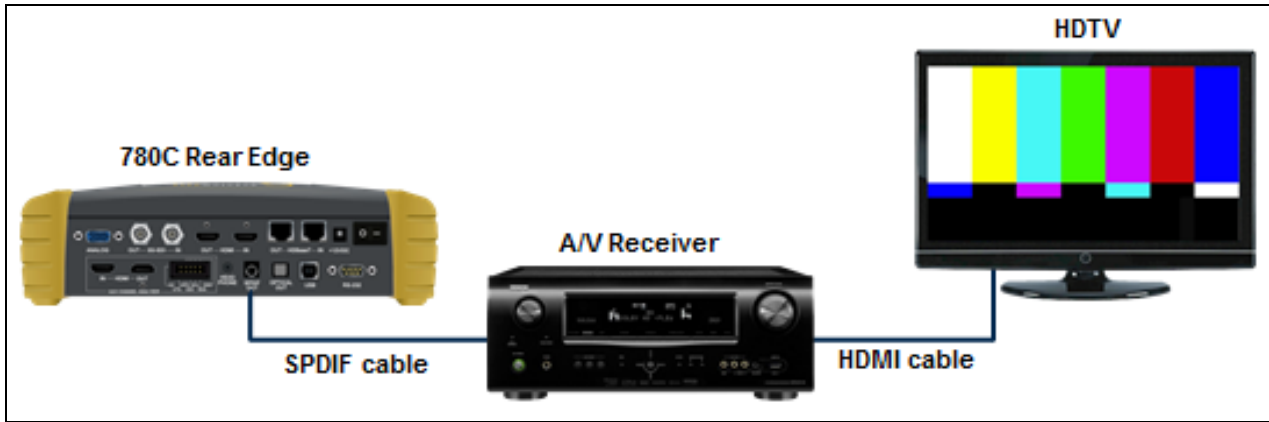
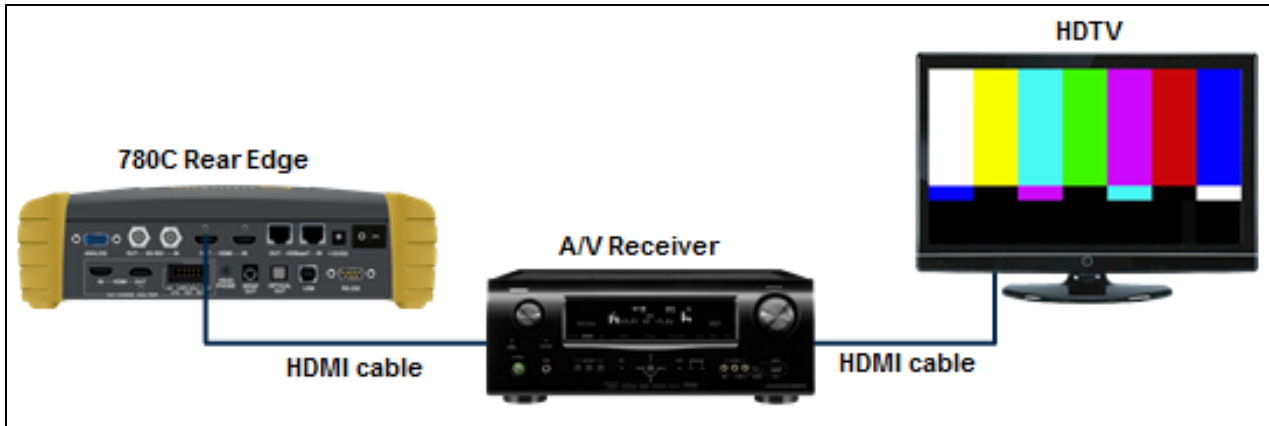
Use the following procedures to make the physical connections from the 780C to the audio rendering device under test.

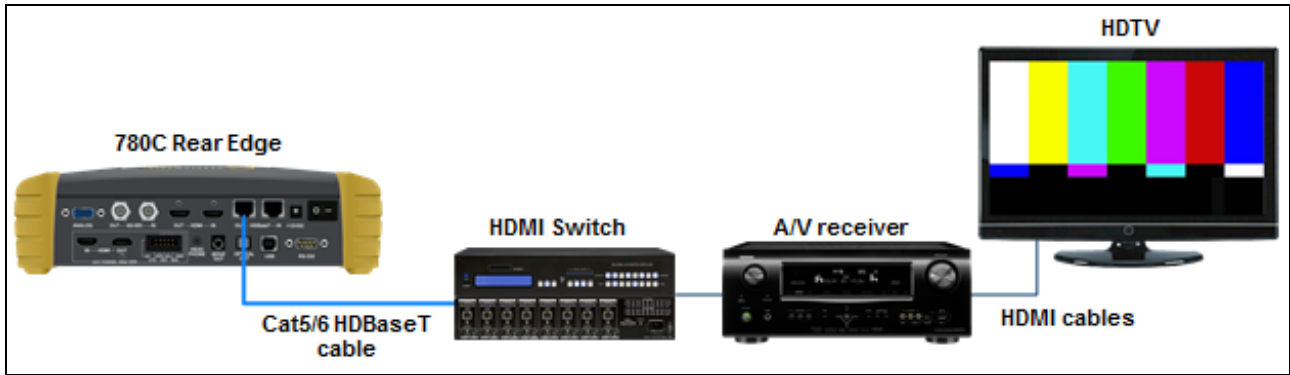
September 3, 2014	Revision A1
-------------------	-------------

1. Make the cable connection between the appropriate the 780C video output connector (e.g. HDMI OUT, SPDIF or OPTICAL) and the input connector of the audio rendering device using the cables supplied.

Alternatively you may connect from the 780C video output connector to an HDTV through an HDMI repeater device such as an A/V receiver. In this case make the HDMI connection between the HDMI OUT connector on the 780C and the HDMI input of the HDMI repeater device using an HDMI-to-HDMI cable. Then connect the HDTV to an active output on the repeater. The following illustrations depict the typical test configurations.

The following illustrations depict the test setups for the HDMI audio, SPDIF audio and optical (TOSLink). Note also that you can test directly into an HDTV without going through an A/V receiver.



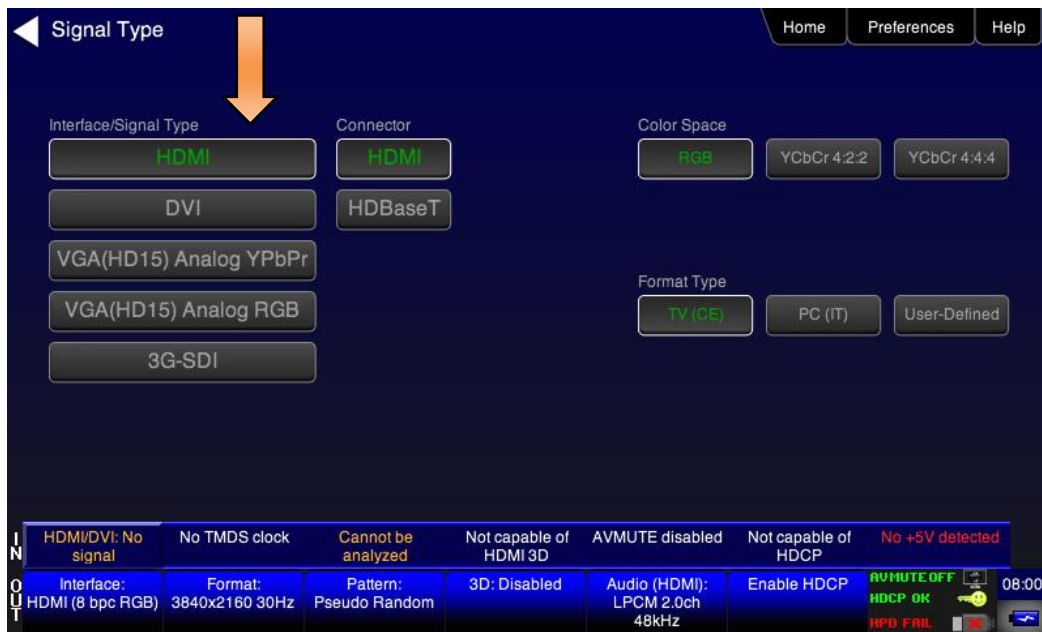


4.7.2 Procedures for Testing a Display with Dolby Digital or DTS Audio Test Patterns

Use the following procedures to run audio tests using Dolby Digital and or DTS audio test patterns. These test patterns are useful for calibrating the room acoustics in a home theatre system.

1. Make the physical connections between the 780C and the audio rendering device as described in the procedures above.
2. Select the digital interfaces—HDMI, HDBaseT or SDI—output as shown below.

Note for testing SPDIF of TOSLink this is not necessary.



3. From the **Home** menu (shown in the figure below), select the Audio status/activation button on the Status Bar as indicated below.



4. Enable the digital audio interface (HDMI, HDBaseT, SDI, TOSLink, SPDIF). Refer to the screen examples below.



Please note that not all of the audio formats are available on all of the Interface types.

5. Touch select the desired **Interface** from the **Audio Pattern** menu (refer to the screen shot above which shows HDMI). The options are Optical, SPDIF or HDMI.
6. Double touch select the **Dolby Digital 5.1** or **DTS-ES 6.1** item on the **Audio Pattern** menu (refer to the screen shot above).

The following screen appears (DTS-ES shown):



- Touch select the desired audio test pattern. (**500-2kHz Pink** is shown selected in the sample screen shot above and **Sine Wave** shown in the screen shot below.) Use the information in Table 4-6 below to understand the application of each audio test pattern.



Note: When selecting Sine Wave at 1kHz or 4kHz the 780 will output 5.0 audio. This is because the subwoofer frequency response is 20Hz to 200Hz.

Table 4-6: Audio Pattern Tests			
Pattern	Format	Interfaces	Range of Values

Table 4-6: Audio Pattern Tests			
Pattern	Format	Interfaces	Range of Values
Pink Noise Patterns: <ul style="list-style-type: none"> 500-2kHz Pink noise 20-20kHz Pink noise Application: <ul style="list-style-type: none"> Tests sound pressure level Main speaker frequency response 	Dolby Digital 5.1	HDMI HDBASET SDI SPDIF Optical HDMI ARC (780C only)	<ul style="list-style-type: none"> Individually selectable channels Cycle – cycling through each channel; 8 seconds per channel
	DTS-ES 6.1	HDMI HDBASET SDI SPDIF Optical HDMI ARC (780C only)	
Sine Wave Pattern: <ul style="list-style-type: none"> 63Hz 125Hz 1kHz (5.0 only - no subwoofer) 4kHz (5.0 only - no subwoofer) Application: <ul style="list-style-type: none"> Speaker distortion 	Dolby Digital 5.1	HDMI HDBASET SDI SPDIF Optical HDMI ARC (780C only)	Channel selection: <ul style="list-style-type: none"> Select All channels or... Cycle – cycling through each channel; 8 seconds per channel
	DTS-ES 6.1	HDMI HDBASET SPDIF SDI Optical HDMI ARC (780C only)	
Impulse Pattern Application: <ul style="list-style-type: none"> Early reflections 	Dolby Digital 5.1	HDMI HDBASET SPDIF SDI Optical HDMI ARC (780C only)	<ul style="list-style-type: none"> Individually selectable channels Cycle – cycling through each channel; 8 seconds per channel
	DTS-ES 6.1	HDMI HDBASET SPDIF Optical HDMI ARC (780C only)	
Polarity Pattern Application: <ul style="list-style-type: none"> Polarity of the speaker wires 	Dolby Digital 5.1	HDMI HDBASET SPDIF Optical HDMI ARC (780C only)	<ul style="list-style-type: none"> Individually selectable channels Cycle – cycling through each channel; 8 seconds per channel
	DTS-ES 6.1	HDMI HDBASET SPDIF Optical HDMI ARC (780C only)	

Table 4-6: Audio Pattern Tests			
Pattern	Format	Interfaces	Range of Values
Auto Time Delay Application: <ul style="list-style-type: none"> Fine tunes sound convergence using the distance setting in an AVR 	Dolby Digital 5.1	HDMI HDBASET SPDIF Optical HDMI ARC (780C only)	<ul style="list-style-type: none"> Individually selectable channels Cycle – cycling through each channel; 8 seconds per channel
	DTS-ES 6.1	HDMI HDBASET SPDIF Optical HDMI ARC (780C only)	

4.7.3 Procedures for Testing a Display with Dolby Digital or DTS Sine Wave Clips

Table 4-7 below summarizes the 780C support for digital audio.

Table 4-7: Summary of Audio Sine Wave Clips		
Sine Wave Audio Clips	Interfaces	Description
Dolby Digital Plus 7.1	HDMI HDBASET SDI	Provides a set of Dolby Digital Plus 7.1 sine wave clips: <ul style="list-style-type: none"> 2.0 192kHz – 2 channel @ 192kHz sampling rate 5.1 192kHz – 6 channel @ 192kHz sampling rate 7.1 192kHz – 8 channel @ 192kHz sampling rate
Dolby TrueHD	HDMI HDBASET	Provides a set of Dolby TrueHD Hi Bit Rate sine wave clips: <ul style="list-style-type: none"> 192kHz 7.1 1kHz TrueHD – 8 channel @ 192kHz sampling rate 192kHz 7.1 2kHz TrueHD – 2 channel @ 192kHz sampling rate
DTS HD HRA	HDMI HDBASET	Provides a set of DTS-HD Hi Bit Rate sine wave clips: <ul style="list-style-type: none"> 192kHz 7.1 5376kb HDHRA – 8 channel @ 192kHz sampling rate 192kHz 5.1 3840kb HDHRA – 6 channel @ 192kHz sampling rate 192kHz 7.1 5760kb HDHRA – 8 channel @ 192kHz sampling rate
DTS HD Master Audio	HDMI HDBASET	Provides a set of DTS-HD Hi Bit Rate sine wave clips: <ul style="list-style-type: none"> 192kHz 7.1 HDMA – 8 channel @ 192kHz sampling rate 192kHz 5.1 HDMA – 6 channel @ 192kHz sampling rate

Use the procedures below for testing multi-channel Dolby or DTS sine wave using clips.

1. Make the cable connection between the appropriate the 780C video output connector (e.g. HDMI, HDBaset OUT, SPDIF or OPTICAL) and the input connector of the audio rendering device using the cables supplied.
2. From the top level menu (shown in the figure below), select **Audio Test Tone**.



The **Audio Pattern (Test Tone)** menu appears as shown below:



3. Touch select the desired **Interface** from the **Audio Pattern (Test Tone)** menu (refer to the screen shot above which shows HDMI). The options are Optical, SPDIF or HDMI.
4. Double touch select the **Dolby Digital Plus 7.1/TrueHD** or **DTS-HD** item on the **Audio Pattern (Test Tone)** menu (refer to the screen shot above).

One of the following screens will appear:



5. Touch select the desired clip.

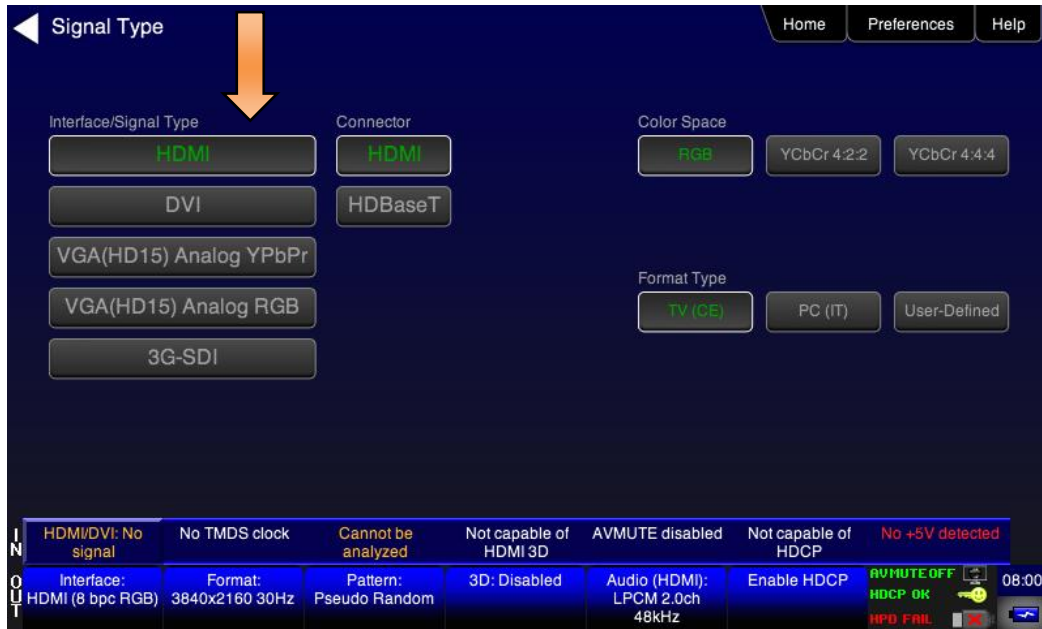
4.7.4 Procedures for Testing with Programmable Sine Waves

Use the procedures below for testing with programmable sine waves. Table 4-8 below describes the audio sine wave parameters that can be configured.

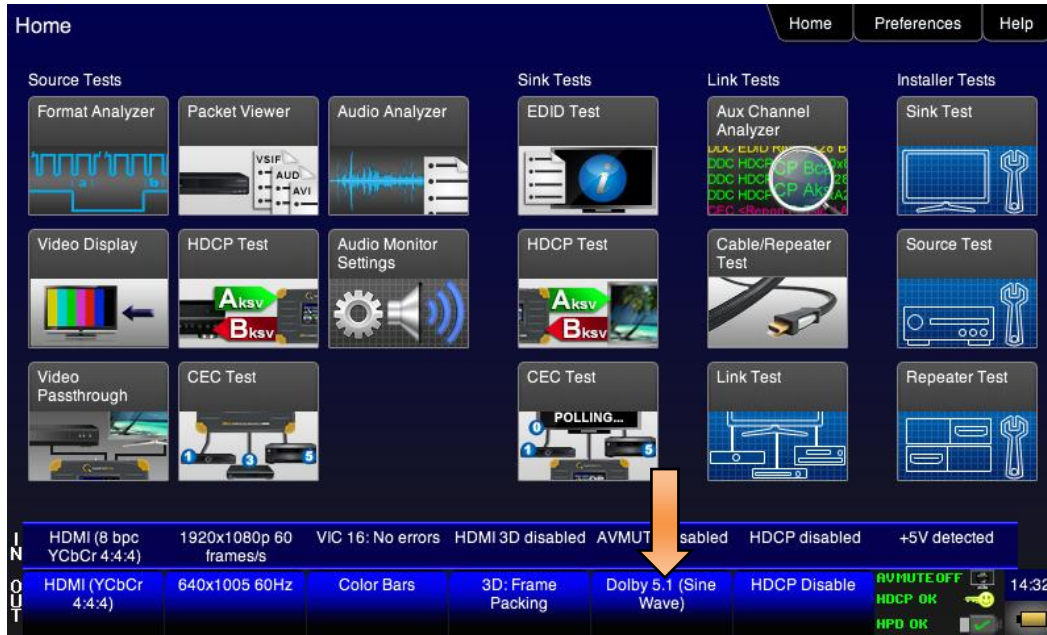
Table 4-8: Sine Wave Audio Pattern		
Pattern	Interface	Description

Table 4-8: Sine Wave Audio Pattern		
Pattern	Interface	Description
PCM Sine Wave (programmable)	<ul style="list-style-type: none"> ▪ HDMI ▪ HDBaseT ▪ Optical ▪ SPDIF ▪ HDMI ARC ▪ SDI 	Provides programmable sine waves: <ul style="list-style-type: none"> ▪ Bits per sample – 16, 20, 24 ▪ Sampling rate (kHz) – 32, 44.2, 48, 88.2, 96, 176.4, 192 ▪ Channels – 2.0, 2.1, 5.1, 6.1, 7.1 ▪ Level – 0dB to -99dB in 1dB and 3dB increments (per channel) ▪ Frequency – 0.01kHz to 20kHz (per channel) in 1Hz, 10Hz, 100Hz and 1000Hz increments ▪ Mute – On/Off (per channel)

1. Make the cable connection between the appropriate the 780C video output connector (e.g. **HDMI OUT**, **HDBaseT OUT**, **SPDIF** or **OPTICAL**) and the input connector of the audio rendering device using the cables supplied.
2. Select the digital interfaces—HDMI, HDBaseT or SDI—output as shown below.
 Note for testing SPDIF of TOSLink this is not necessary.



3. From the **Home** menu (shown in the figure below), select the Audio status/activation button on the Status Bar as indicated below.



The **Audio Pattern (Test Tone)** menu appears as shown below:



4. Touch select the desired **Interface** (shown in the screen above) to select the active digital audio output. (Optical selected in the example screen shot above.)
5. Double touch select the **PCM Sine Wave** item (shown in the screen above).

The **PCM Sine Wave Options** menu appears as shown below:



6. Touch select the values for the **Bits per Sample** using the three buttons provided. (24 bits is selected in the example above.)
7. Touch select the **Sampling Rate** by incrementing the associated arrows adjacent to the current value. (Refer to the screen shot above which shows 96 kHz selected.)
8. Touch select the **Channels** by incrementing the associated arrows adjacent to the current value. (Refer to the screen shot above which shows 7.1 selected.)
9. Specify the **Level** by touch selecting the associated increment or decrement buttons showing +3dB and -3dB. (Refer to the screen shot above which shows the level at 0dB.) Repeat for each channel. You can specify the level for each channel individually.
10. Specify the **Frequency** of the sine wave by touch selecting the associated increment or decrement buttons. There are four buttons on the left of the current value. (1.00 kHz is shown selected in the screen shot above) The four buttons provide a variety of increment and decrement values for convenience. Repeat for each channel. You can specify the frequency for each channel individually in 1 Hz increments
11. Specify which channels you want to mute by touch selecting a channel and then touch selecting the Mute activation button. You can only select one channel at a time. Note that only the active channels (the ones specified in **Channels** will be selectable. (Refer to the screen shot above.)

4.7.5 Testing HDMI Audio Return Channel (ARC) 780C only

You can test the HDMI 1.4 Audio Return Channel using the 780C. The selected audio is output from the 780C's HDMI IN connector in this case. The HDMI IN connector emulates an ARC Tx device to test the ARC Rx function on an A/V Receiver that supports the Audio Return Channel.

Note: The 780C does not support the CEC commands necessary to activate the ARC Rx function in the connected A/V receiver. Therefore you will have to have some other method of activating this ARC function in the A/V receiver under test.

1. Make the cable connection between the 780C HDMI or HDBaseT IN connector and the A/V receiver's HDMI 1.4 capable output connector.

The following illustration depicts the test setups for the HDMI audio return channel. In the first diagram, the 780C is emulating an ARC Tx at its HDMI Input port.



1. From the top level menu (shown in the screen sample below), select **Audio Test Tone**.



The **Audio Test Tone** menu appears as shown below:



2. Select **ARC**.
3. Select the desired audio **Signal Type**.

Table 4-9 below describes the audio format available for testing the HDMI Audio Return Channel.

Table 4-9: HDMI Audio Return Channel (ARC) Testing	
Audio Interface	Audio Formats
HDMI ARC	<ul style="list-style-type: none"> ▪ Dolby 5.1 ▪ DTS-ES 6.1 ▪ PCM Sine Wave

5 Using the 780C Test Instrument to Test HDMI and HDBaseT Protocols on Sink Devices

This section provides procedures for testing HDMI or HDBaseT sink devices such as HDTVs, projectors and inputs on repeater devices.

5.1 Testing HDCP on an HDMI, HDBaseT HDTV, Projector or Repeater Device

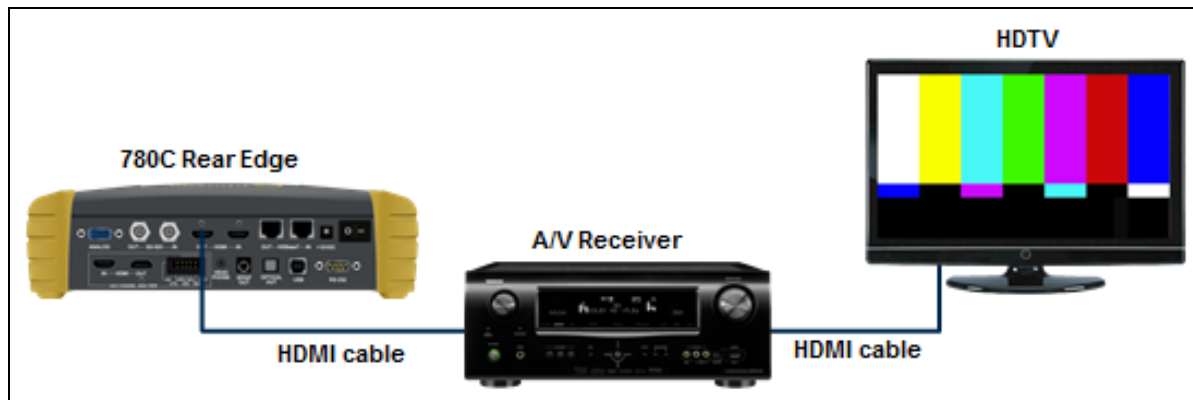
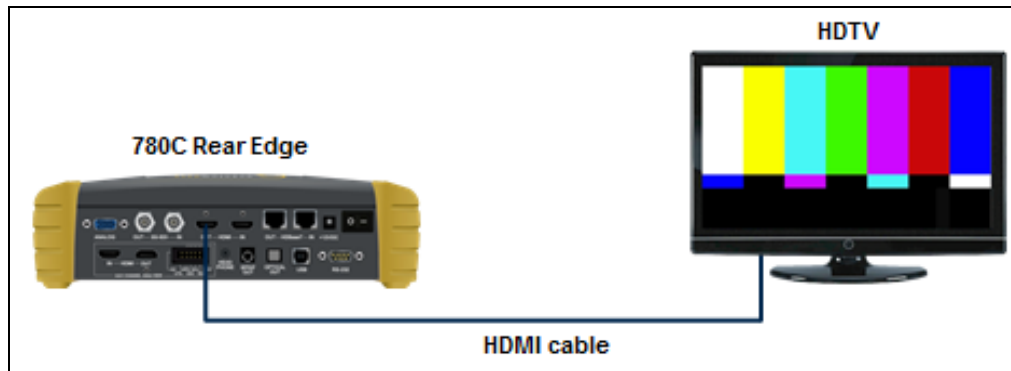
This section provides procedures for testing HDCP on an HDMI or HDBaseT equipped HDTVs, projectors or inputs on repeaters or distribution devices. The HDCP authentication test initiates and HDCP authentication with the sink device (with or without a repeater) and displays the AKSV and BKSV values, the An value, the Ro values and the Ri values. A pass/fail indication is provided as well.

5.1.1 Configurations for Testing HDCP on an HDMI Sink Device

You can run this test in two configurations.

- 780C HDMI OUT port connected directly to an HDTV input
- 780C HDMI OUT port connected to a repeater device which is then connected to a downstream HDTV.

These configurations are shown below:

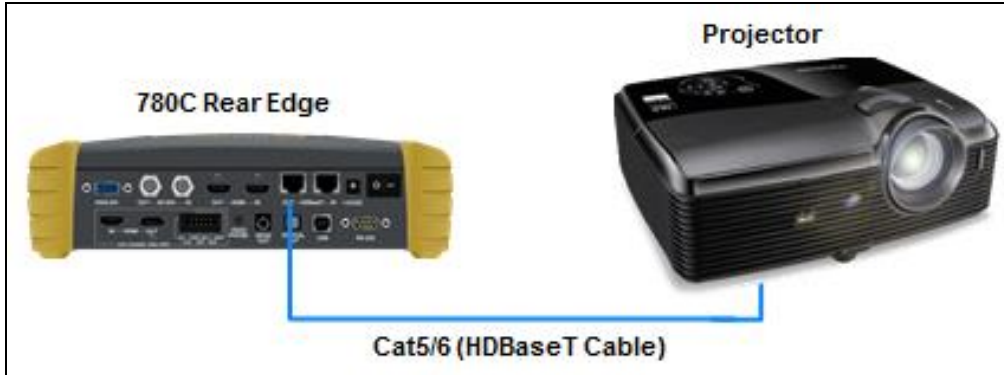


5.1.2 Configurations for Testing HDCP on an HDBaseT Sink Device

You can run this test in two configurations.

- 780C HDBaseT OUT port connected directly to a projector's input

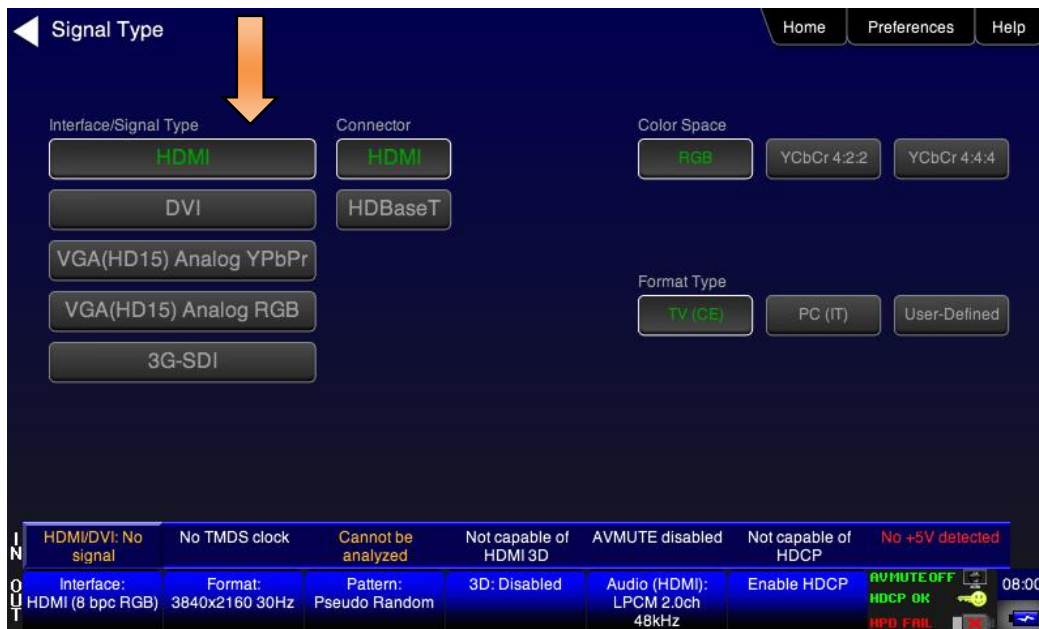
These configurations are shown below:



5.1.3 Procedures for Testing HDCP on an HDMI or HDBaseT Sink Device

Use the procedures below to run an HDCP test on an HDMI or HDBaseT sink.

1. Make the physical connections between the 780C HDMI/HDBaseT OUT connector and the sink device under test.
2. Enable the HDMI or HDBaseT interface. Refer to the screen below.



3. Touch select **HDCP Test** from the **Home** menu shown below.



4. Touch select **Enable** from the **HDCP Output Tests** menu shown below.



The Pass/Fail results and the key values exchanged during the authentication are presented on the display as shown below:



5. Touch select **Auto-Restart** to restart HDCP authentication.

Alternatively you can run this test from the command line as follows:

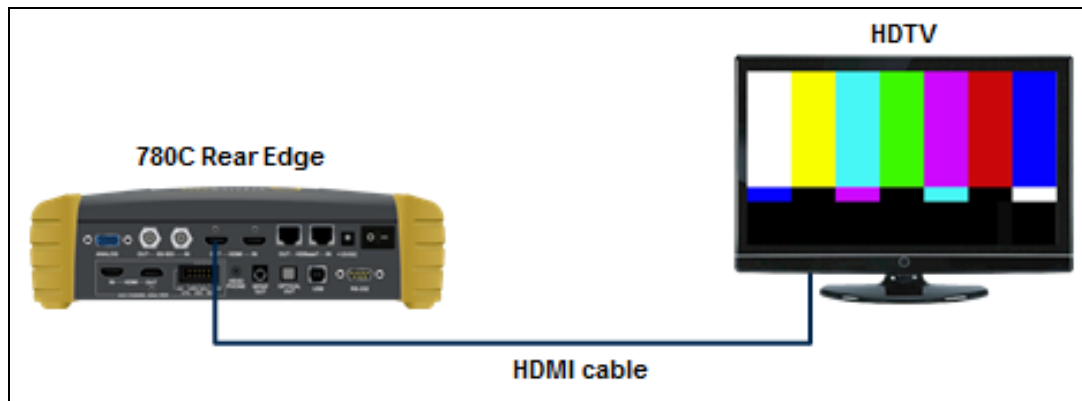
```
HDCP?
0 // indicates pass (1 indicates a failure)
```

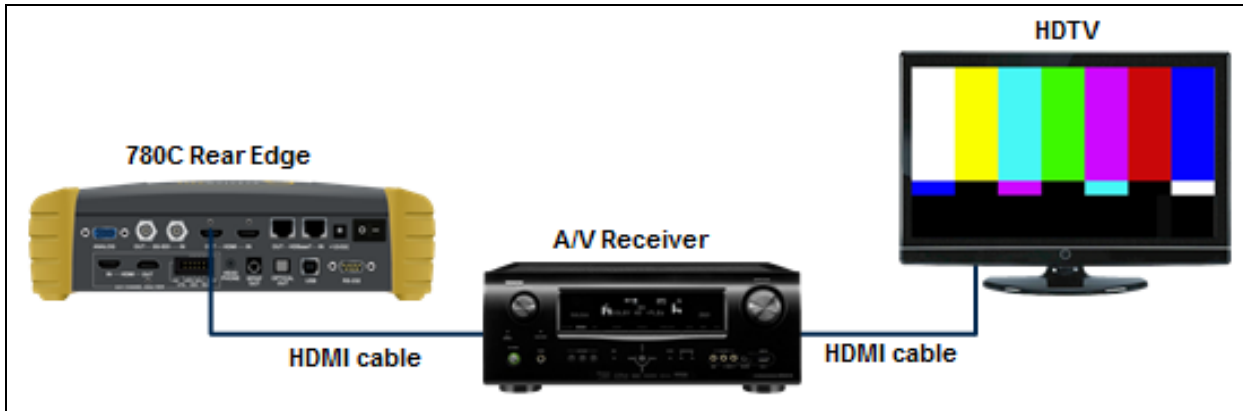
5.2 Verifying the EDID on an HDMI, HDTV, HDBaseT Projector or HDMI Repeater Device

This section provides procedures for verifying and viewing the EDID of an HDMI/HDBaseT HDTV, projector or an HDMI repeater device such as an A/V receiver. You can also compare two EDIDs.

5.2.1 Configurations for Verifying and Viewing the EDID on an HDMI Sink Device

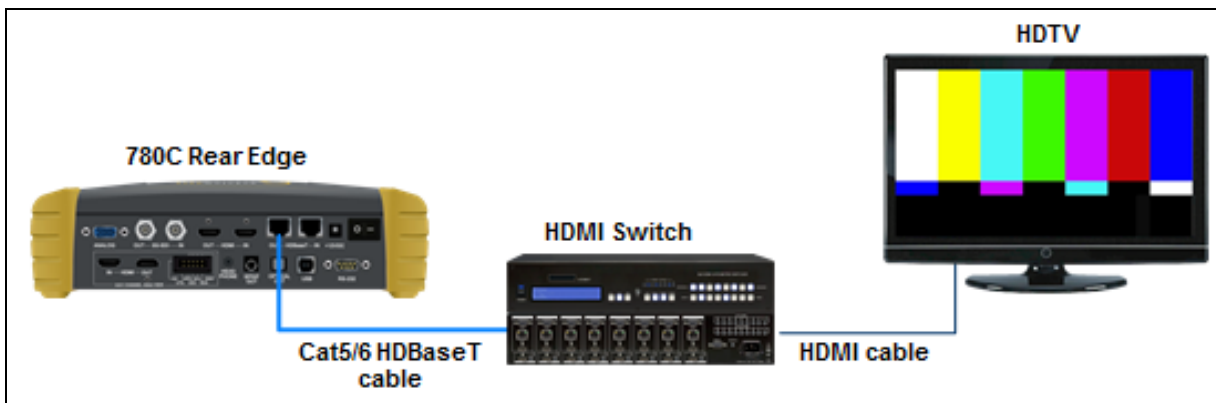
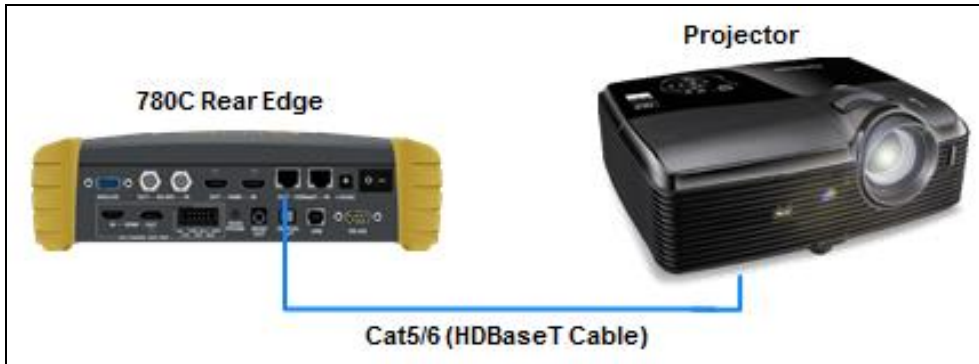
The following illustrations depict the typical test setups. You can either connect directly to an HDTV or to a repeater device connected to an HDTV.





5.2.2 Configurations for Verifying and Viewing the EDID on an HDBaseT Sink Device or Input of an HDBaseT Distribution Device

The following illustrations depict the typical test setups. You can either connect directly to an HDBaseT projector or input of an HDBaseT distribution device.

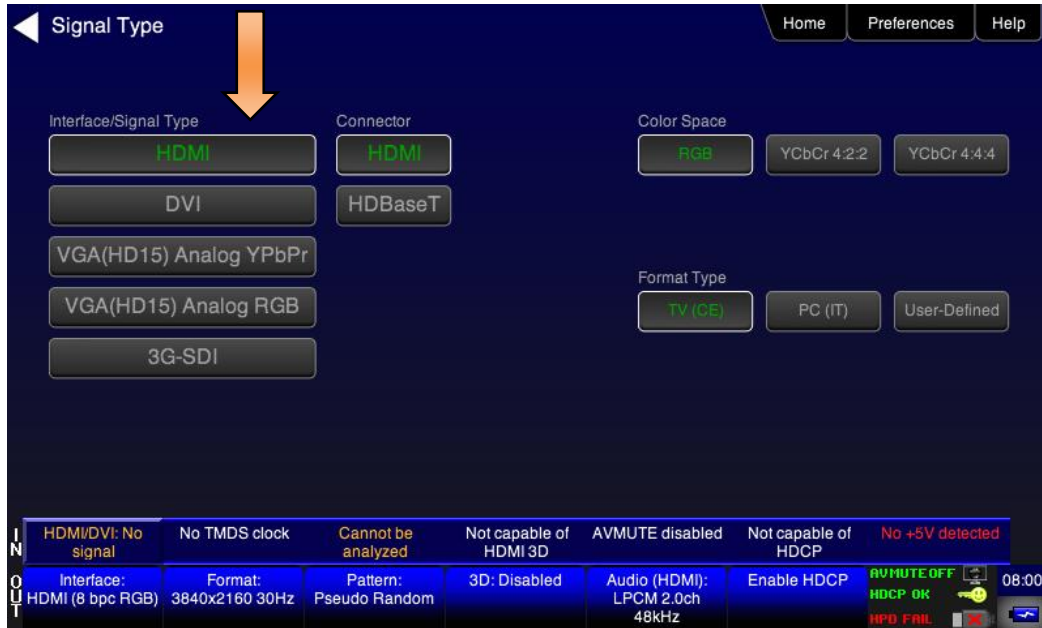


5.2.3 Procedures for Testing and Viewing the EDID on an HDMI/HDBaseT Sink Device

Use the procedures below to run an EDID test on an HDMI sink.

1. Make the physical connections between the 780C **HDMI OUT** connector and the display device under test.
2. Enable the HDMI or HDBaseT interface as shown below.

Note for testing SPDIF of TOSLink this is not necessary.



3. Touch select **EDID** from the **Home** menu shown below.



4. Touch select the Read activation button from the EDID Test menu shown below.

The EDID information is presented on multiple pages on the display. An example of a few of the pages of an EDID listing is shown below. You scroll through all the pages using the scroll bar at the right side of the listing. In addition, the EDID test runs a check on the EDID header and checksum to determine if the EDID is valid and runs a portion of the EDID compliance test of the HDMI Compliance Test Specification.

EDID Test Home Preferences Help

EDID Summary:
 Header is OK. All checksums OK. EDID Ver. 1.3
 HDMI: Yes (PA 1.0.0.0, 36, 30 bit color, 3D supported)
 Manufacturer/Product: QDI 30730
 Pref. Native Timing: 3840x2160 30.00Hz
 SVDs: 480i 480p 576i 576p 720p 1080i 1080p 1080p24
 Speakers: [RLC/RRC RL/RR FC LFE FL/FR]
 PCM 8 ch., [32 44.1 48 88.2 96 176.4 192] kHz @ [16 20 24] bits
 AC-3 8 ch., [32 44.1 48] kHz, max rate 640 kHz
 DTS 8 ch., [44.1 48] kHz, max rate 1536 kHz
 Dolby DD+ 8 ch., [44.1 48] kHz
 DTS-HD 8 ch., [44.1 48 88.2 96 176.4 192] kHz
 MAT (MLP) 8 ch., [44.1 48 88.2 96 192] kHz

IN HDMI (8 bpc RGB) 3840x2160p 30.00 frames/s Unknown HDMI 3D disabled AVMUTE disabled HDCP disabled +5V detected
 OUT Interface: Format: Pattern: 3D: Disabled Audio (SDI): Enable HDCP AVMUTE OFF 07:14
 HDMI (8 bpc RGB) Passthrough Mode Pseudo Random LPCM 2.0ch HDCP FAIL HPD OK

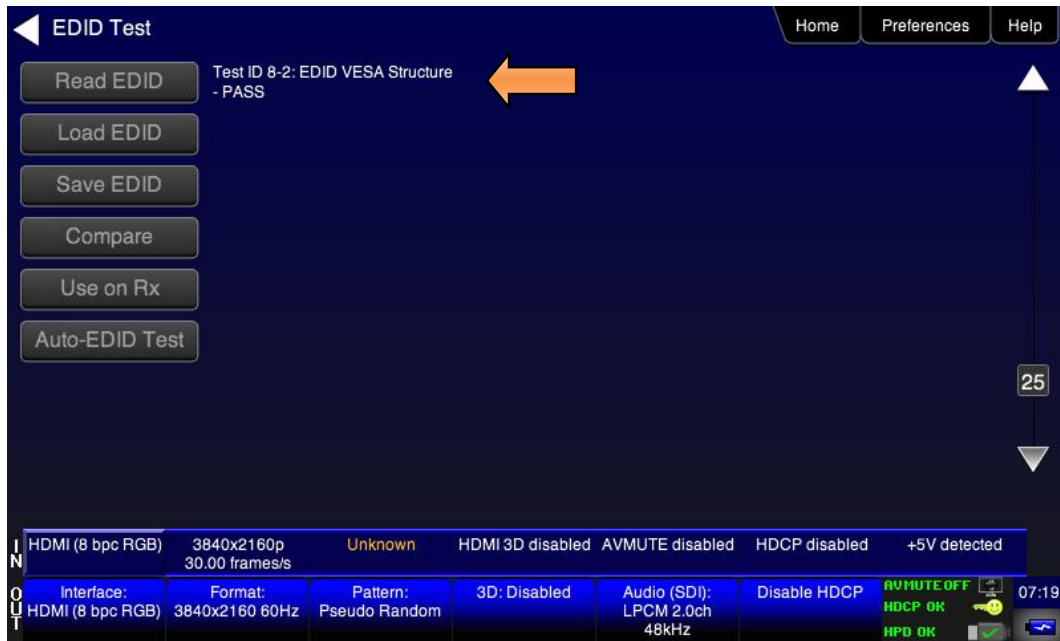
EDID Test Home Preferences Help

Descriptor Block 1 (Detailed Timing)
 Pixel clock: 297.00MHz
 Active video: 3840 x 2160
 Total video: 4400 x 2250
 HSYNC: Delay 176, Width 88
 VSYNC: Delay 8, Width 10
 Image size: 800mm x 450mm
 Border: 0 pixels x 0 lines
 Scan type: Progressive
 Stereo mode: Normal display, no stereo
 Sync: Digital Separate, VSYNC+, HSYNC+,

IN HDMI (8 bpc RGB) 3840x2160p 15 frames/s **HDMI_VIC 1: Bad VRAT** HDMI 3D disabled AVMUTE disabled HDCP disabled +5V detected
 OUT Interface: Format: Pattern: 3D: Disabled Audio (HDMI): Enable HDCP AVMUTE OFF 06:36
 HDMI (12 bpc RGB) 3840x2160 30Hz Color Bars LPCM 2.0ch HDCP FAIL HPD OK



The EDID sink test will also run certain sections of the EDID compliance test. The sections that are run are those sections that do not require Capabilities Declaration Form (CDF) information to be entered for example Test ID 8-2 shown in the following screen example below.



5.2.4 Workflow for Comparing EDIDs

Use the following procedures to compare two EDIDs. The following is the workflow for comparing two EDIDs.

- Load a reference EDID either from an EDID file stored on the 780C or an EDID you have obtained from an HDTV and subsequently stored.
- Load the reference EDID.
- Connect the 780C **HDMI OUT** or **HDBaseT OUT** port to the sink device whose EDID you wish to compare with your reference EDID.
- Compare the two EDIDs.

Note: To load an EDID use the procedures described in [Adding Reference EDIDs for Use in Testing HDMI Devices](#).

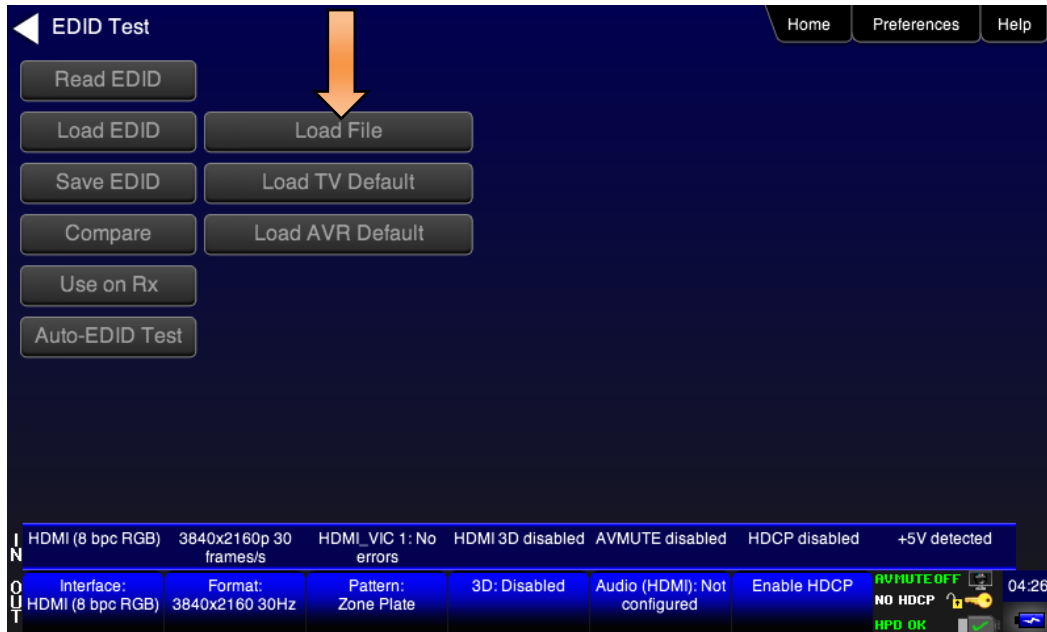
5.2.5 Procedures for Comparing EDIDs

Use the following procedures to compare two EDIDs.

1. Follow the procedures above for [Selecting a Signal Type and Resolution](#) to enable the HDMI output.
2. Touch select **EDID** from the **Home** menu shown below.



3. Touch select **Load** from the **EDID Tests** menu. The following screen results.



4. Touch select the **Load** option from the **EDID Test** menu shown above that you want to use as a reference EDID. The options:

- Load File – Loads from an EDID file stored on the 780C file system
- Load TV Default – Loads the standard reference EDID for a TV from the 780C file system
- Load AVR Default - Loads the standard reference EDID for a AVR from the 780C file system

5. If you have selected the **Load File** option, the following screen results. Select the file that you wish to use as the reference EDID. In the example below there is only one file.



The EDID is loaded and displayed on the screen.



- Connect the 780C **HDMI OUT** or **HDBaseT OUT** port to a sink device (e.g. HDTV, projector or A/V receiver) and touch select **Compare**. The results will show PASS or FAIL with an explanation as in the following two screen examples.



When a failure occurs the following message is displayed.



5.3 Viewing the CEC devices on an HDMI/HDBaseT network

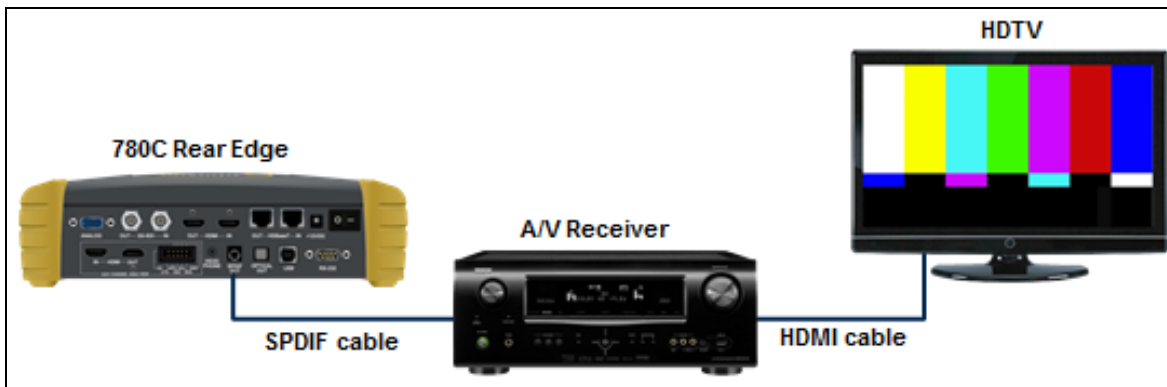
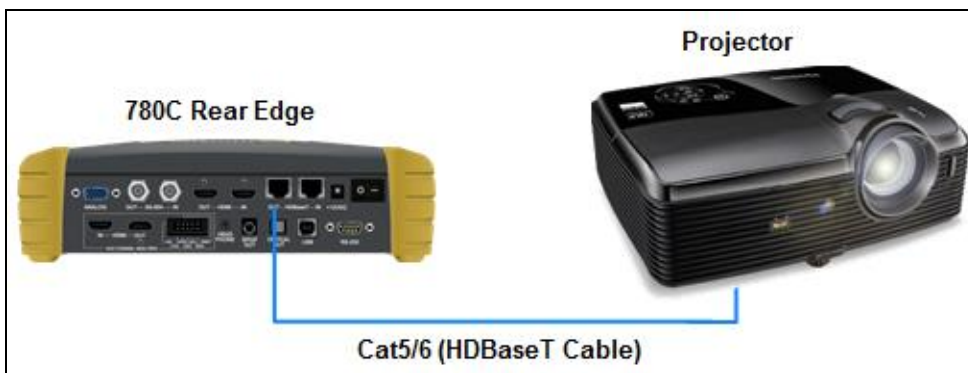
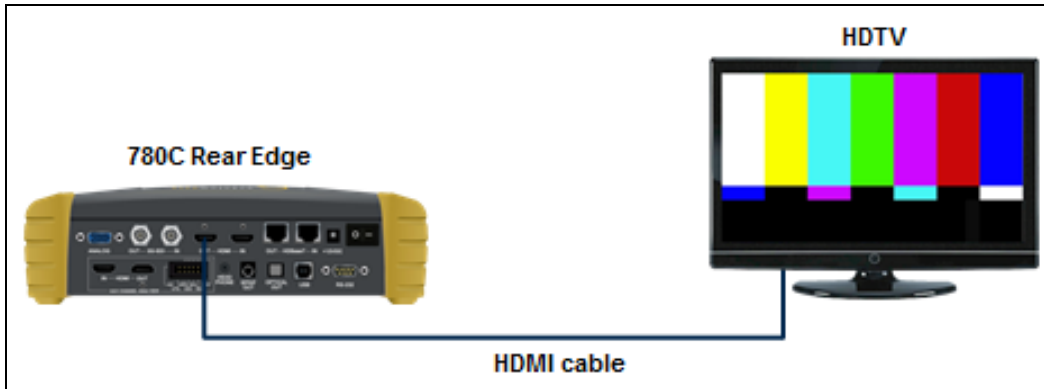
This section describes how to view the CEC devices on an HDMI/HDBaseT network.

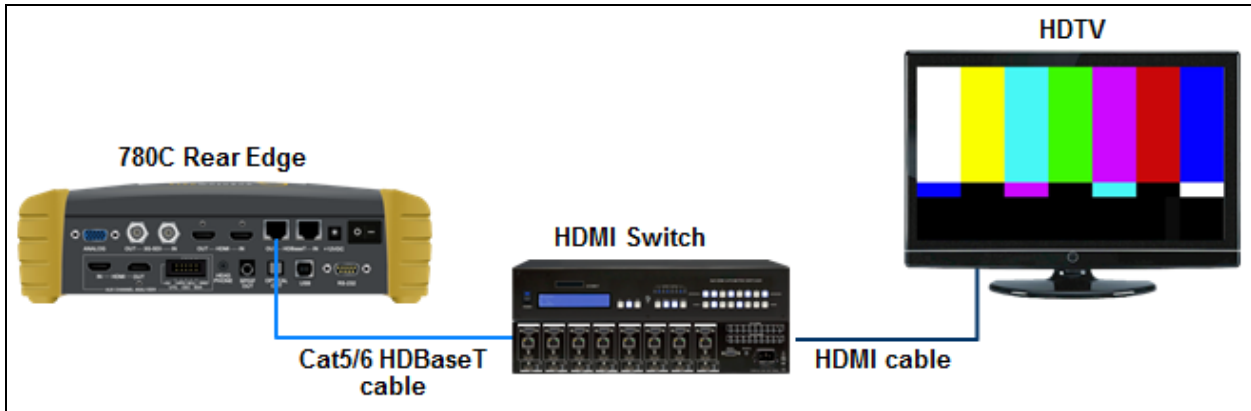
5.3.1 Configurations for Testing CEC on an HDMI/HDBaseT Sink Device

You can run this test in two configurations.

- 780C HDMI/HDBaseT OUT port connected directly to an HDTV or projector input
- 780C HDMI/HDBaseT OUT port connected to a repeater device which is then connected to a downstream HDTV.

These configurations are shown below:





5.3.2 Procedures for Testing CEC on an HDMI/HDBaseT Sink Device

Use the following procedures to test CEC on an HDMI/HDBaseT sink device.

1. Connect the 780C **HDMI/HDBaseT OUT** port to an HDMI/HDBaseT sink device (e.g. HDTV or A/V receiver) using the configuration guidelines provided above.
2. Follow the procedures above for Selecting a Signal Type and Resolution to enable the HDMI/HDBaseT output.
3. Touch select **CEC Test** from the **Home** menu shown below.



The CEC devices on the HDMI network are presented on the display as shown below:



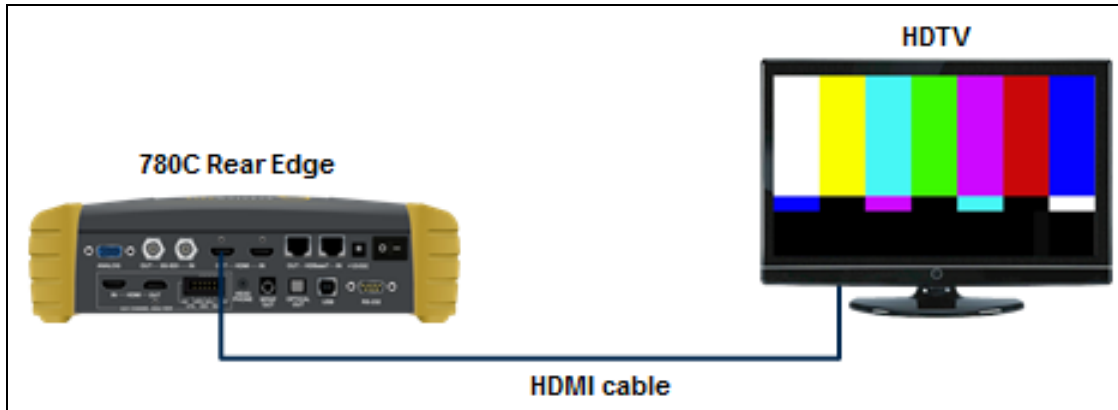
5.4 Multi-protocol (HDCP, EDID and CEC) testing on an HDMI or HDBaseT HDTV or Projector

This section provides procedures for testing HDCP, EDID and CEC using the Aux Combo Test image. The Aux Combo Test image runs tests similar to the individual HDCP, EDID and CEC tests except that the results are displayed on the HDTV or projector that the 780C HDMI or HDBaseT output is connected to.

5.4.1 Configurations for running multi-protocol tests on an HDMI Sink Device

You run this test with the 780C HDMI OUT port connected directly to an HDTV input

This configuration is shown below:



5.4.2 Configurations for running multi-protocol tests on an HDBaseT Sink Device

You run this test with the 780C HDBaseT OUT port connected directly to a projector or HDBaseT input on a distribution device.

This configuration is shown below:

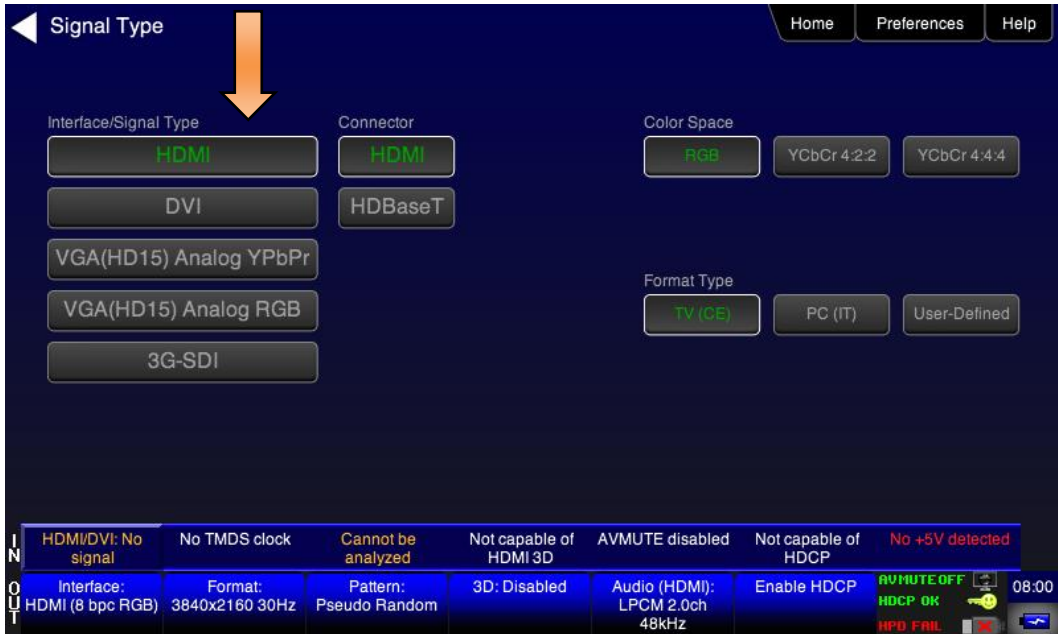


5.4.3 Procedures for running multi-protocol tests on an HDMI or HDBaseT Sink Device

Use the procedures below to run a multi-protocol test on an HDMI or HDBaseT sink.

1. Make the physical connections between the 780C HDMI or HDBaseT OUT connector and the display device under test.
2. Enable the HDMI or HDBaseT interface as shown below.

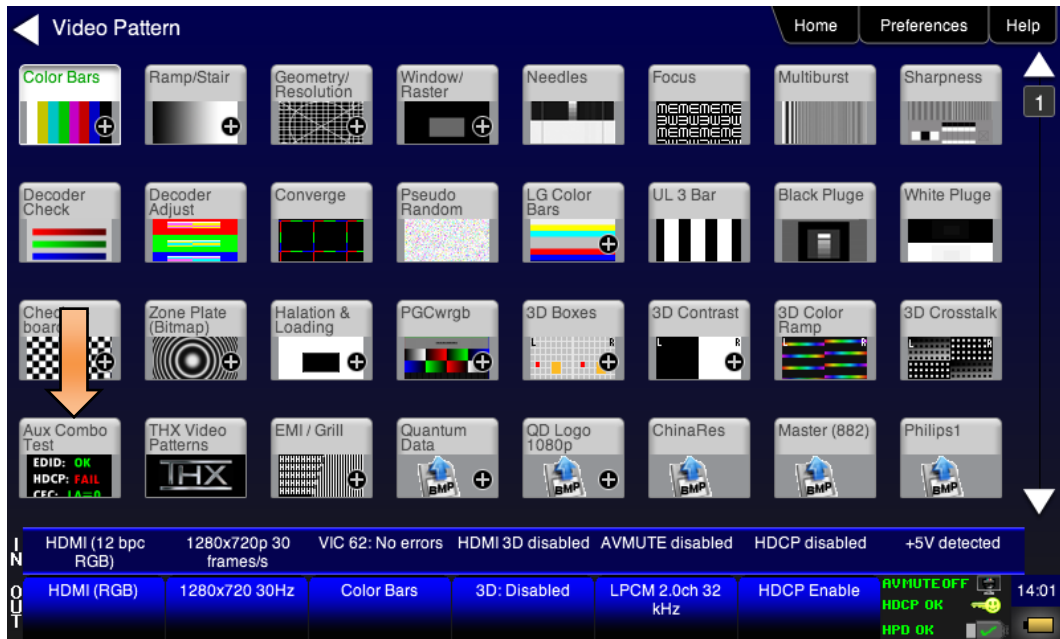
Note for testing SPDIF of TOSLink this is not necessary.



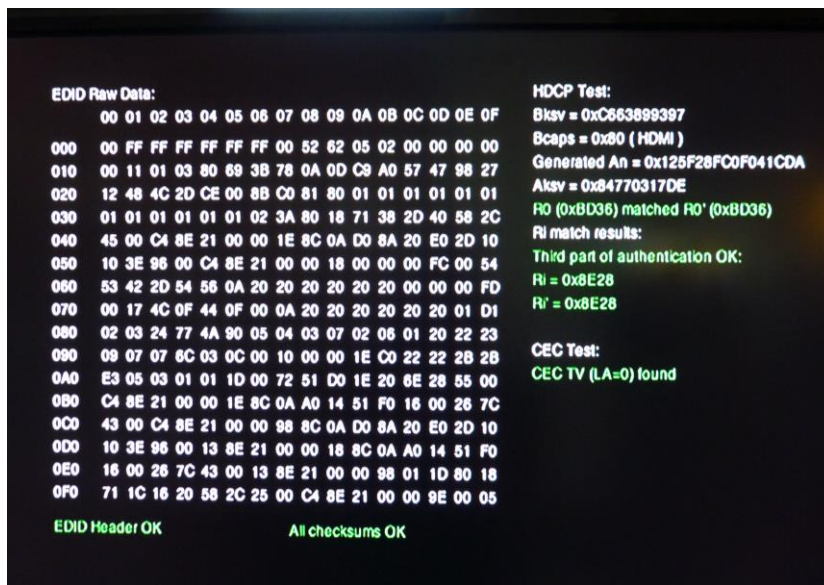
3. Touch select video pattern status and activation button on the lower right of the LCD interface.



4. Touch select the Aux Combo Test pattern from the second page of the Video Pattern menu shown below.



The results will appear on the connected display. An example of the results is shown below:



4. Alternatively you can run the AuxComboTest from the command line as follows:

```

IMGL AuxTest
IMGU
    
```

6 Using the 780C Test Instrument to Test HDMI or HDBaseT Source Devices

This section provides procedures for testing HDMI source devices such as DVD players, set top boxes and HDMI and HDBaseT outputs on repeater and distribution devices.

6.1 Testing Video from an HDMI Source Device

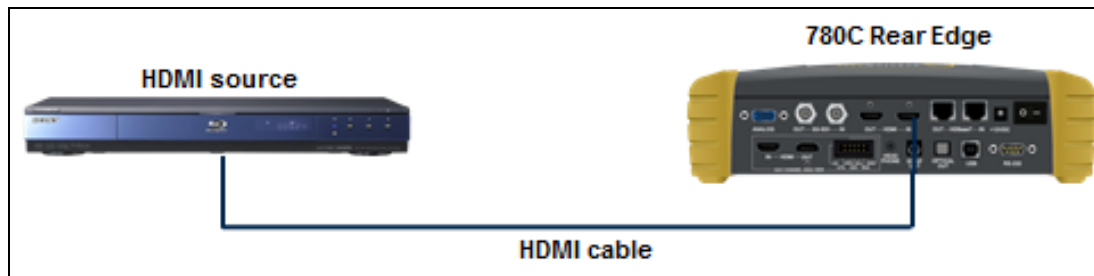
This subsection describes how to test the video on HDMI source devices.

6.1.1 Connection Configurations for Testing HDMI Source Devices

The 780C's HDMI input port acts as a "reference" HDMI sink device. Therefore it enables you to emulate a known good HDMI sink device to conduct a basic confidence test of an HDMI source device or output of an HDMI distribution or repeater device. This test ensures that you are receiving a valid HDMI video signal by displaying the timing of the incoming signal and informing you whether it is HDCP encrypted or not. You can run this test in three configurations:

- Source device connected directly to the 780C **HDMI IN** connector.
- Source device connected to the 780C **HDMI IN** connector through a repeater device.
- 780C **HDMI OUT** and **HDMI IN** ports acting as both as a known good source and a known good sink connect to both the input and output of the repeater device.

In all cases the 780C is emulating a sink to test an upstream source. In the third configuration, the 780C is emulating both an HDMI source and sink. These test configurations are shown below.





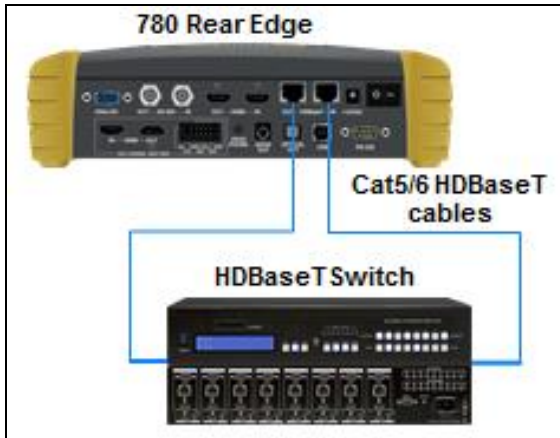
6.1.2 Connection Configurations for Testing HDBaseT Outputs on Repeater and Distribution Devices

The 780C’s HDMI input port acts as a “reference” HDBaseT sink device. Therefore it enables you to emulate a known good HDBaseT sink device to conduct a basic confidence test of an HDBaseT output of an HDBaseT distribution or repeater device. This test ensures that you are receiving a valid HDBaseT video signal by displaying the timing of the incoming signal and informing you whether it is HDCP encrypted or not. You can run this test in three configurations:

- Source device connected to the 780C **HDBaseT IN** connector through a repeater device.
- 780C **HDBaseT OUT** and **HDBaseT IN** ports acting as both as a known good source and a known good sink connect to both the input and output of the repeater device.

In all cases the 780C is emulating a sink to test an upstream source. These test configurations are shown below.

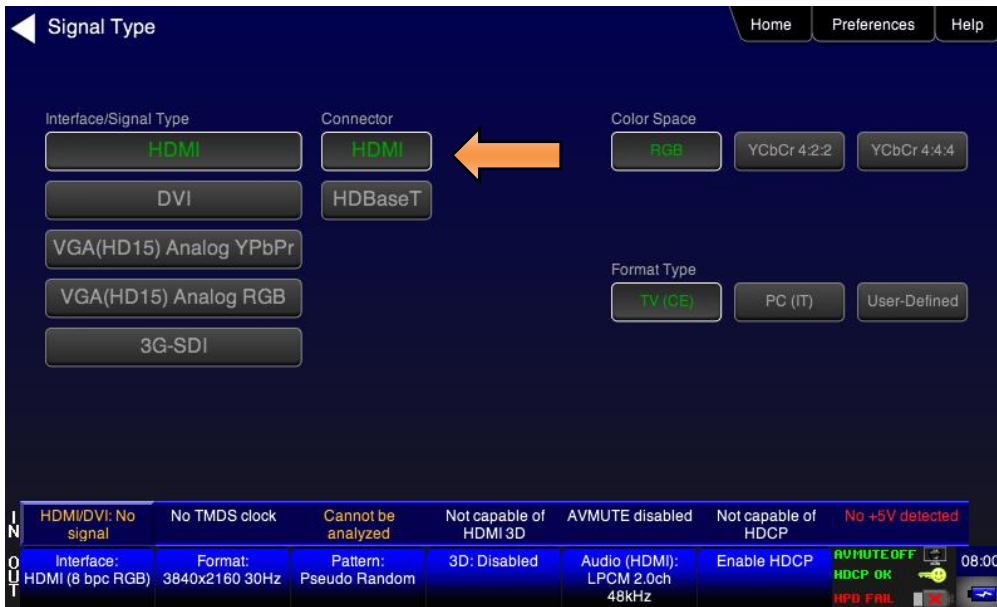




6.1.3 Procedures for Viewing Video on an HDMI/HDBaseT Source Device

Use the following procedures to test the video from an HDMI/HDBaseT source device. You can view the incoming video and check the video and timing parameters of the incoming video.

1. Make the physical connection between the 780C HDMI/HDBaseT IN port and the source device under test using the configuration instructions above.
2. Enable the HDMI or HDBaseT Input port.



3. Touch select **Video Display** from the **Home** menu shown below.



- 4. Touch select the **Start Fullscreen** activation button on the **Video Display** menu to view only the incoming video (no metadata) from the source device under test.



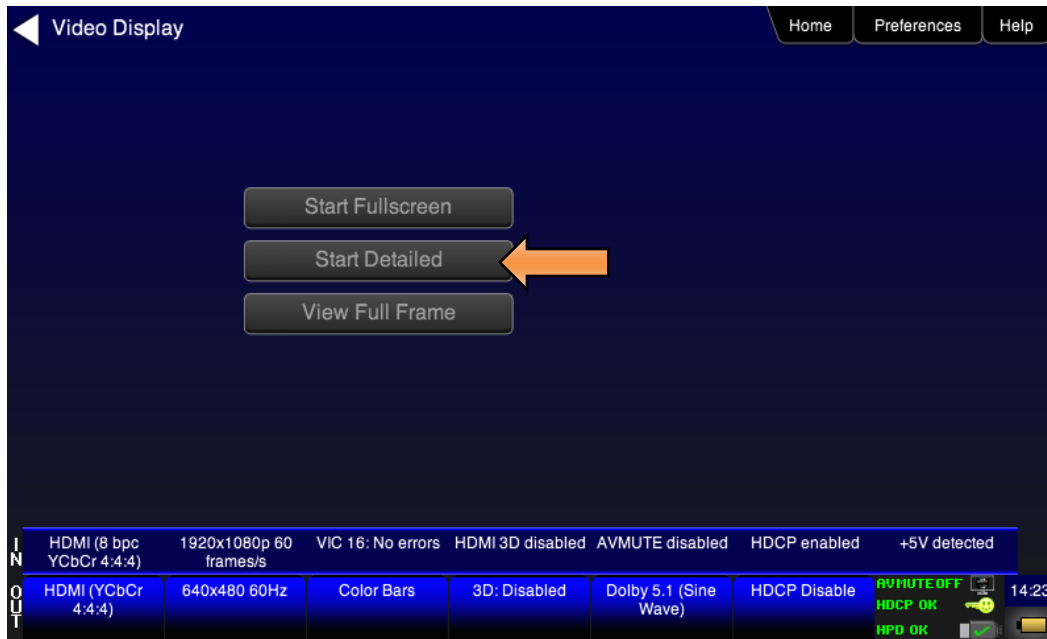
The video from the source is shown on the 780C LCD as depicted below.



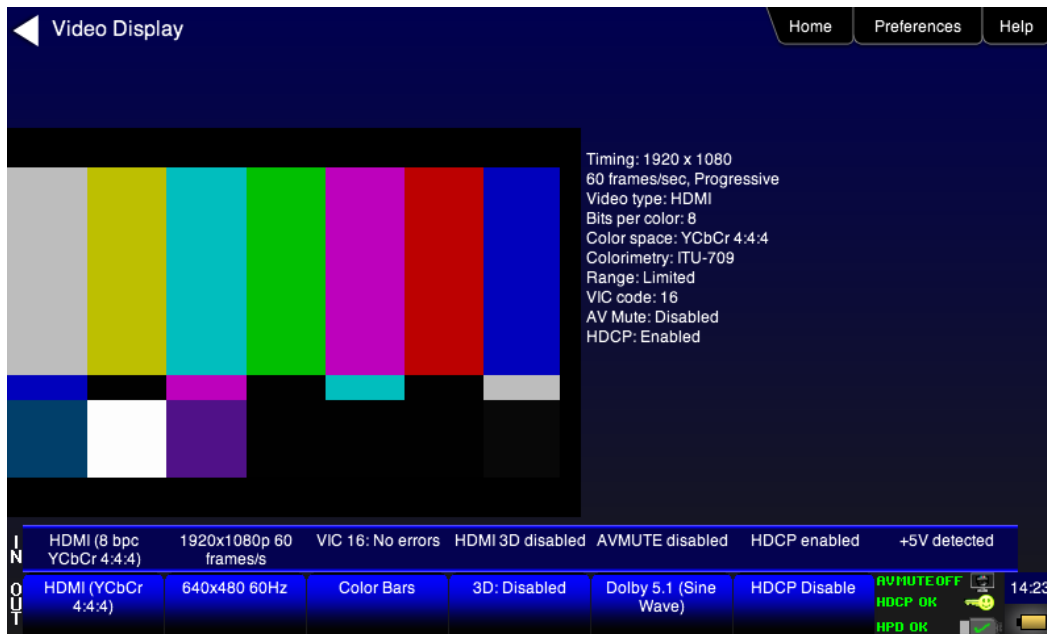
- Return to the Source Test menu by touching the LCD. The **Source Test** menu reappears as shown below. Note that you can also view 3D video bitmaps as well. The following screen is a sample of what a 3D bitmap would look like. The example below is a Top-and-Bottom format.



- Touch select the screen to return to **Video Display** menu.



7. Touch select the **Start Detailed** activation button on the **Video Display** menu to view the incoming video along with the metadata from the source device under test. In this example a test pattern is shown.
Note that the HDCP encryption status and AVmute status are also shown.



1. For the 780C you have the additional option of capturing and viewing a captured bitmap of the entire resolution of the incoming video **View Full Frame**.



Use the arrows to move about the video frame. Note that in the example below the 780 is receiving a test pattern; typically this screen would show video from a source device.



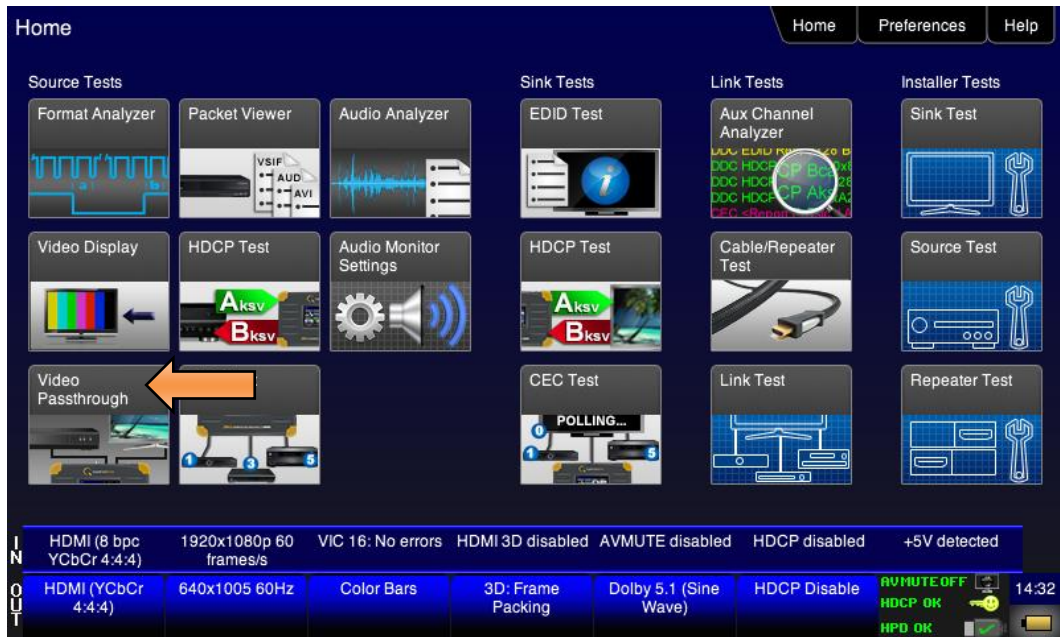
8. Return to the **Home** menu by touching the LCD then the **Home** menu.



6.1.4 Viewing the Incoming 4K HDMI/HDBaseT Video on a Connected Display using Passthrough

You can also view 4K incoming video on a connected display using the Video Passthrough feature. Use the following procedures.

1. Touch select **Video Passthrough** from the **Source Tests** menu shown below.



The video passthrough screen is shown below.



- Specify how you want to view the video on the connected display.

You can either view it unscaled on a 4K display, or scaled to 1080p or scaled to 1920 by 1080 resolution. Refer to Table 6-1 below:

Table 6-1: Passthrough options			
Option	Passthrough Enable Mode	4K Passthrough Mode	Application
Passthrough Enable	Off	Not Applicable	HDMI/HDBaseT OUT port uses 780C generator selection
	On	4K to 1080p	4K input horizontal resolution is scaled by 2:1 and the vertical resolution is scaled to 1080 lines. Used for SMPTE 4K inputs.
		4K to 1920x1080p	4K input horizontal resolution is scaled 1920 and the vertical resolution is scaled to 1080 lines. Used for CEA 4K inputs.
		No Downscale	4K input is unscaled as it is passed through the 780C.

6.1.5 Viewing Video Metadata from an HDMI/HDBaseT Source Device

Use the following procedures to verify the video metadata and video timing data from an HDMI/HDBaseT source device.

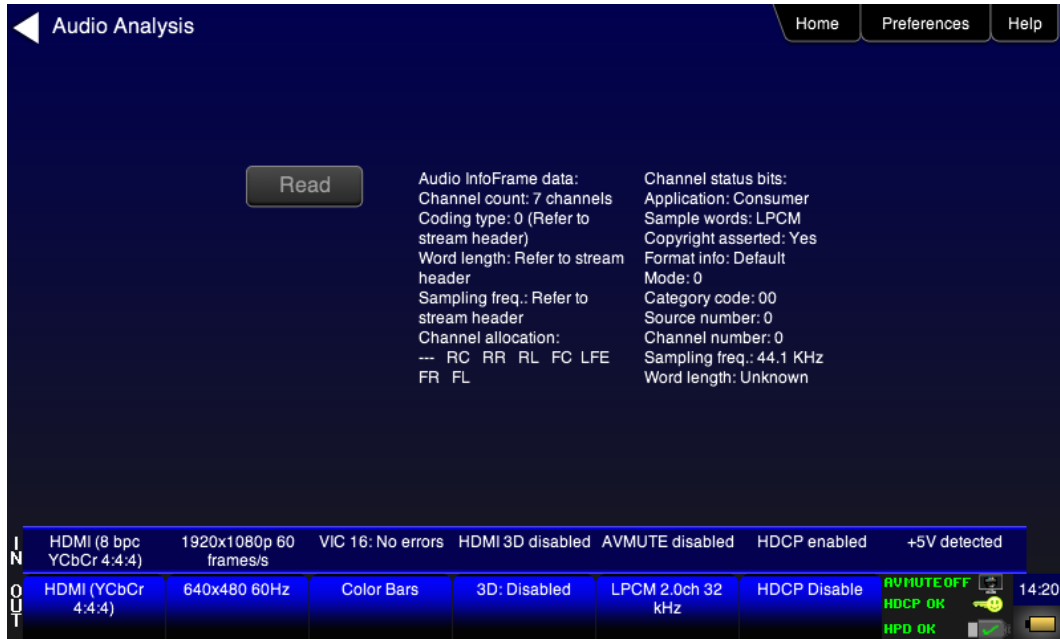
- Enable the HDMI or HDBaseT as the active digital interface input as shown below.



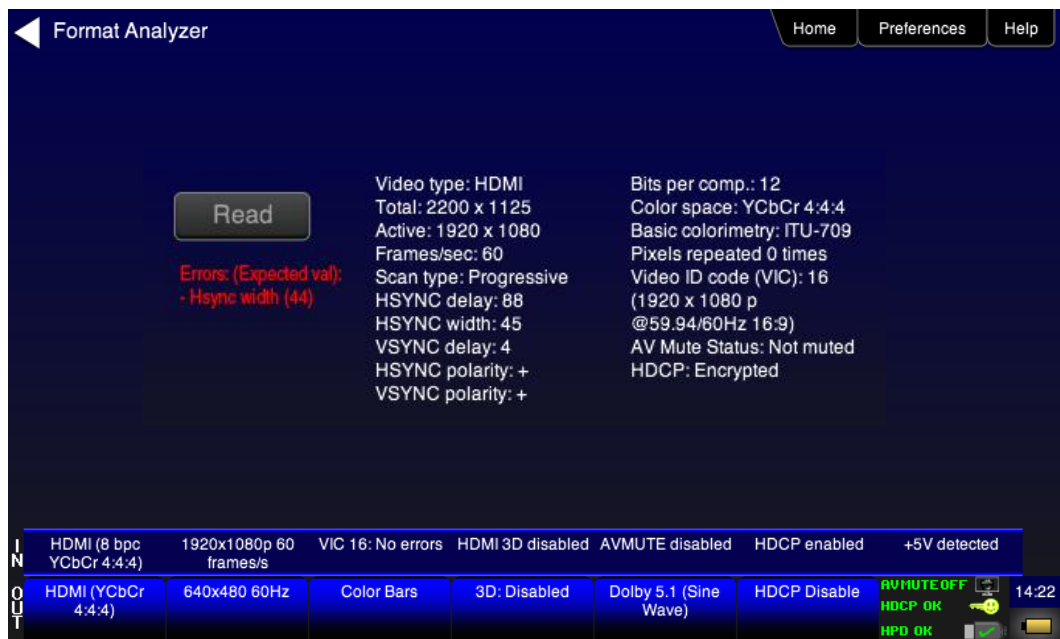
2. Touch select **Format Analyzer** from the **Source Tests** menu shown below.



3. Touch select the **Read** activation button (shown on the screen below) to initiate the test. The results are shown in the screen shots below. The first screen shows a typical pass results, the second screen shows a failure condition and the third screen shows a case where the incoming format was unknown.



If one of the timing parameters does not match the value of the parameters in the associated standard timing in the 780C format library, an indication of the error is shown as can be seen below.



If the timing does not match a standard timing in the 780C format library, a message is shown: "Unknown format" as can be seen below.



Table 6-2 below describes each field in the Format Analyzer on-screen report. The basic timing information is shown on the left of the resulting screen and the AVI infoframes received are displayed on the right. Also displayed on the right side is an indication of the status of HDCP encryption.

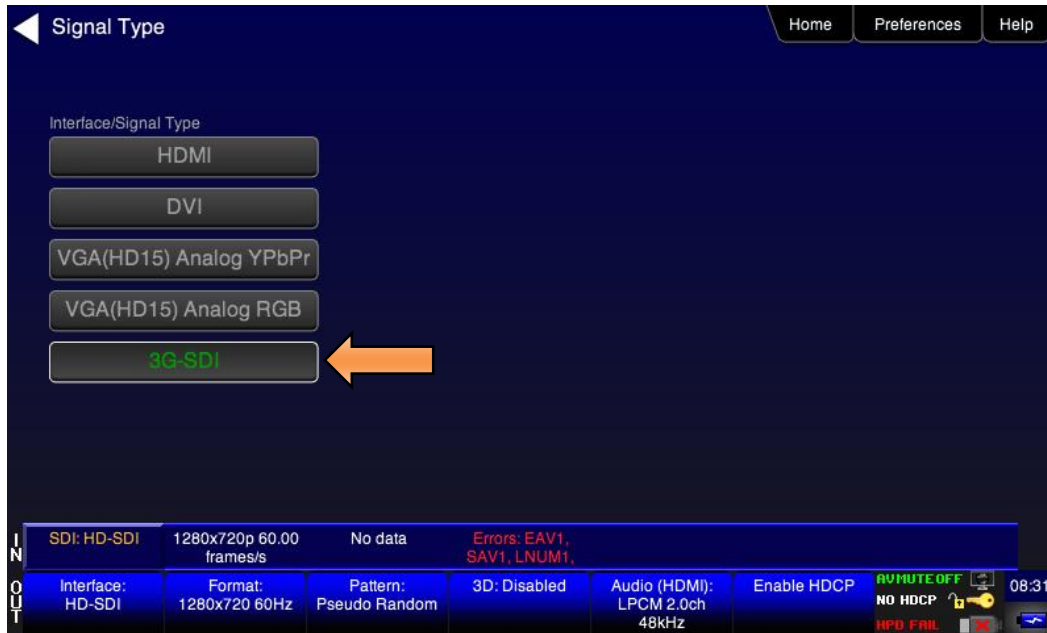
Table 6-2: Format Analyzer	
Timing Parameters (left side)	Description
Video Type	Indicates whether the source is HDMI or DVI.
Total	Total horizontal and vertical resolution including blanking.
Active	Total active horizontal and vertical resolution excluding blanking.
Frames/sec	The frame rate of the HDMI/DVI input source.
Scan Type	Indicates whether the HDMI/DVI input source is progressive or interlaced.
HSYNC delay	The horizontal sync pulse delay in pixels.
HSYNC width	The horizontal sync pulse width in pixels.
VSYNC delay	The vertical sync pulse delay in lines.
VSYNC width	The vertical sync pulse width in lines.
HSYNC polarity	The polarity of the horizontal sync pulse; either positive (+) or negative (-).
VSYNC polarity	The polarity of the vertical sync pulse; either positive (+) or negative (-).
AVI Infoframe Parameters (right side)	Description
Bits per comp	The number of bits per component color. Can be 6, 8, 10, 12, 16.

Table 6-2: Format Analyzer	
Color space	Color space and sampling Color space: <ul style="list-style-type: none"> ▪ YCbCr ▪ RGB ▪ xvColor Sampling: <ul style="list-style-type: none"> ▪ 4:4:4 ▪ 4:2:2 ▪ 4:2:0
Basic colorimetry	The ITU colorimetry standard.
Pixels repeated	Indicates whether pixel repetition is active.
Video ID code (VIC)	The CEA video identification code number.
Resolution	Shows the horizontal and vertical resolution as well as the frame rate and the aspect ratio.
AVmute status	The current setting of the AVmute parameter in the General Control Packet.
HDCP	Indicates the HDCP encryption status either: 1) Encrypted or 2) Unencrypted.

6.1.6 Procedures for Viewing Video on an SDI Source Device

Use the following procedures to test the video from an SDI source device. You can view the incoming video and check the video and timing parameters of the incoming video.

1. Make the physical connection between the 780C SDI IN port and the source device under test using the configuration instructions above.
2. Enable the SDI Input port.



3. Touch select **Video Display** from the **Home** menu shown below.



- 4. Touch select the **Start Fullscreen** activation button on the **Video Display** menu to view only the incoming video (no metadata) from the source device under test.



The video from the source is shown on the 780C LCD as depicted below.



5. Return to the Source Test menu by touching the LCD. The **Source Test** menu reappears as shown below.
6. Touch select the screen to return to **Video Display** menu.



7. Touch select the **Start Detailed** activation button on the **Video Display** menu to view the incoming video along with the metadata from the source device under test. In this example a test pattern is shown.



For the 780C you have the additional option of capturing and viewing a captured bitmap of the entire resolution of the incoming video **View Full Frame**.



Use the arrows to move about the video frame. Note that in the example below the 780 is receiving a test pattern; typically this screen would show video from a source device.



8. Return to the **Home** menu by touching the LCD then the **Home** menu.



6.1.7 Viewing Video Metadata from an SDI Source Device

Use the following procedures to verify the video metadata and video timing data from an SDI source device.

1. Enable the SDI as the active digital interface input as shown below.



2. Touch select **Format Analyzer** from the **Source Tests**.
3. Touch select the **Read** activation button (shown on the screen below) to initiate the test. The results are shown in the screen shots below. The first screen shows a typical pass results, the second screen shows a failure condition and the third screen shows a case where the incoming format was unknown.



If one of the timing parameters does not match the value of the parameters in the associated standard timing, an indication of the error will be shown.

Table 6-2 below describes each field in the Format Analyzer on-screen report for SDI. The basic timing information is shown on the left of the resulting screen and the metadata data from the far end chip is displayed on the right.

Table 6-2: Format Analyzer - SDI

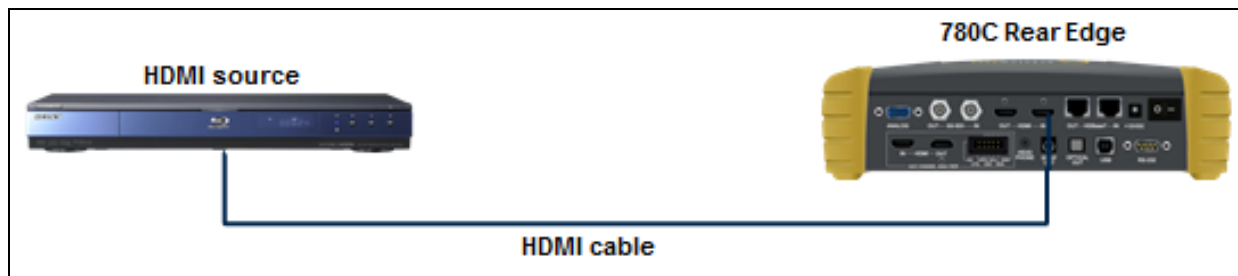
Table 6-2: Format Analyzer - SDI	
Timing Parameters (left side)	Description
Total	Total horizontal and vertical resolution including blanking.
Active	Total active horizontal and vertical resolution excluding blanking.
Frames/sec	The frame rate of the HDMI/DVI input source.
Scan Type	Indicates whether the HDMI/DVI input source is progressive or interlaced.
Video Parameters (right side)	Description
SMPTE embedded Stream 1 Description	Total active lines. E.g. 720.
Picture Rate	Frames per second: E.g. 60
Sampling Structure	Video Type and Sampling: YCbCr 4:2:2
Picture	Scan: Progressive or Interlaced
Bit Depth	Color depth plus overhead: 10 bits
SMPTE embedded packet Stream 2	Alignment level

6.2 Viewing Source Data Island Packets on HDMI and HDBaseT

This subsection describes how to view the HDMI/HDBaseT data island packets from an HDMI source device or HDBaseT output of a repeater or distribution device.

6.2.1 Configurations for Viewing the Data Island Packets from an HDMI or HDBaseT Source Device

The 780C’s HDMI/HDBaseT input ports acts as “reference” HDMI sink devices. Therefore they enable you to emulate a known good HDMI sink device to conduct a test on a source device. You can view the data island packets with the source device connected directly to the 780C. This test configuration is shown below for HDMI and HDBaseT (second illustration).

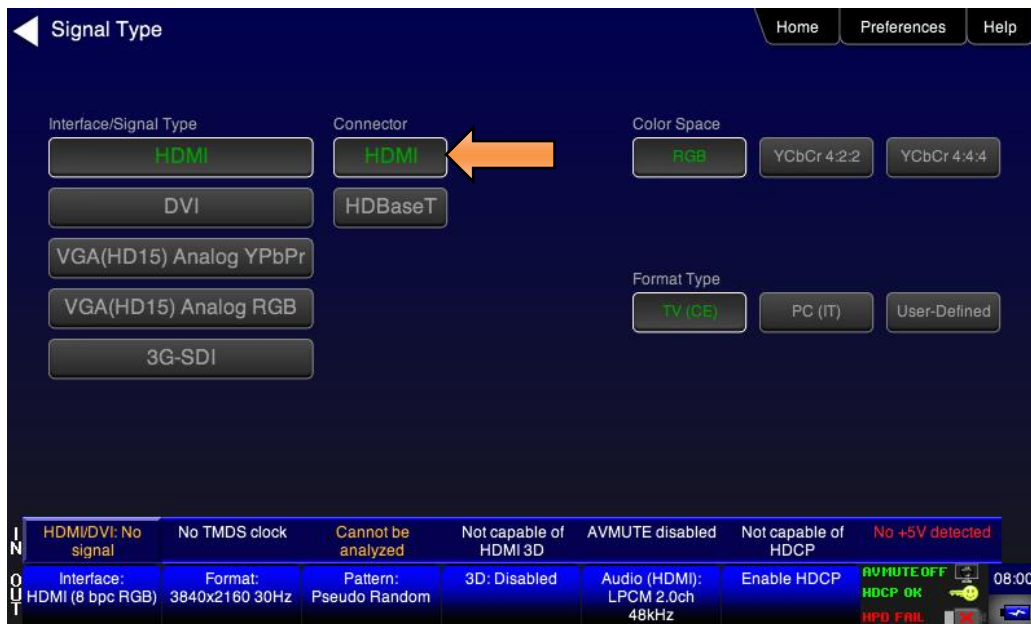




6.2.2 Procedures for Viewing the HDMI/HDBaseT Data Island Packets from a Source Device

Use the following procedures to view the data islands packets from an HDMI source device or output of an HDBaseT distribution device.

1. Connect the HDMI/HDBaseT system devices to the 780C as shown in the diagram above. The HDMI source device output is connected the 780C **HDMI IN** or **HDBaseT IN** connector.
2. Enable the HDMI or HDBaseT as the active digital interface input.



3. Touch select **Packet Viewer** from the **Home** menu shown below.



4. Touch select the **Refresh** activation button on the **Packet Viewer** menu (shown below) to view the data island packet information (AVI Infoframe shown).



5. Touch select the **Save** activation button on the **Packet Viewer** menu to save the data to a file. A keyboard appears enabling you to select a name.



6.3 Testing HDCP Max Devices on an HDMI Source Devices and Outputs of HDBaseT distribution Devices

This subsection describes how to run a test of the number of HDCP devices an HDMI or HDBaseT source device supports. The Max HDCP devices test runs a test on the source device (such as a DVD or STB) to determine how many downstream devices are supported during an HDCP authentication with a repeater device.

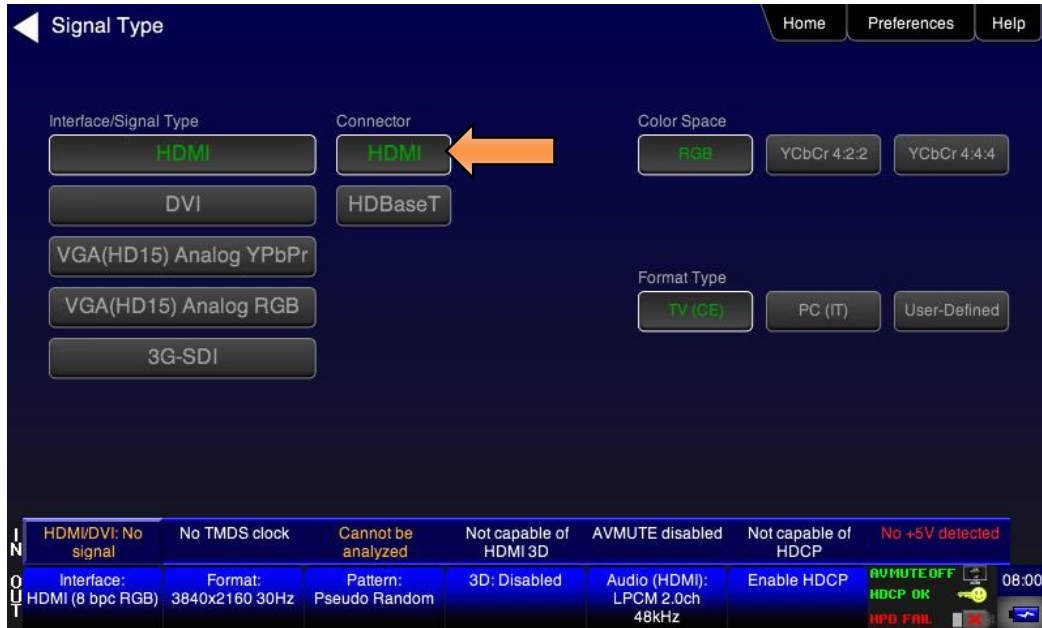
6.3.1 Configurations for Testing Max Devices an HDMI Source Device Supports

The 780C's HDMI input port acts as a "reference" HDMI sink device. Therefore it enables you to emulate a known good HDMI sink device to conduct a test on a source device. You can run this source device connected directly to the 780C. This test configuration is shown below.

6.3.2 Procedures for Testing Max Devices a Source Device Supports

Use the following procedures to test the maximum number of HDCP devices a source device supports.

1. Connect the HDMI system devices to the 780C as shown in the diagram above. The HDMI source device or HDBaseT device output is connected the 780C **HDMI IN** or **HDBaseT IN** connector.
2. Enable the HDMI as the active digital interface input as shown below.



3. Touch select **HDCP Test** from the **Home** menu shown below.





4. Touch select the **Find Max Devs** activation button on the **HDCP Input Tests** menu (shown below) to test the number of HDCP device the source device supports.

The results of the test are shown on the screen.

Note: You can also disable HDCP on the HDMI/HDBaseT Out port using the Allow Rx HDCP toggle button.



The results of the test are shown on the screen.



6.3.3 Procedures for disabling HDCP on the 780C HDMI/HDBaseT Out port - GUI

You can disable the HDCP registers of the 780C’s Rx port to test how your source device responds to HDCP being disabled. You can disable the HDCP port either through the GUI or through the command line.

1. Touch select the **Allow Rx HDCP** activation button to enable / disable HDCP. When the button is green HDCP is enabled.

Note: You can also disable HDCP on the HDMI Rx port using the Allow Rx HDCP toggle button. See procedures below.



6.3.4 Procedures for disabling HDCP on the 780C out port

You can disable the HDCP registers of the 780C's Rx port to test how your source device responds to HDCP being disabled. Currently you can only disable the HDCP port through the command line. For instructions on establishing a command line session with the 780C from your PC refer to the section: [Command Interface](#). Use the commands in the following procedures enable and disable HDCP on the HDMI or HDBaseT In port.

1. To disable HDCP on the HDMI In port enter the following command:

```
CPAG 0
ALLU
```

2. To re-enable HDCP on the HDMI In port enter the following command:

```
CPAG 1
ALLU
```

6.4 Testing Audio of an HDMI Source Device or at the Output of an HDBaseT Distribution Device

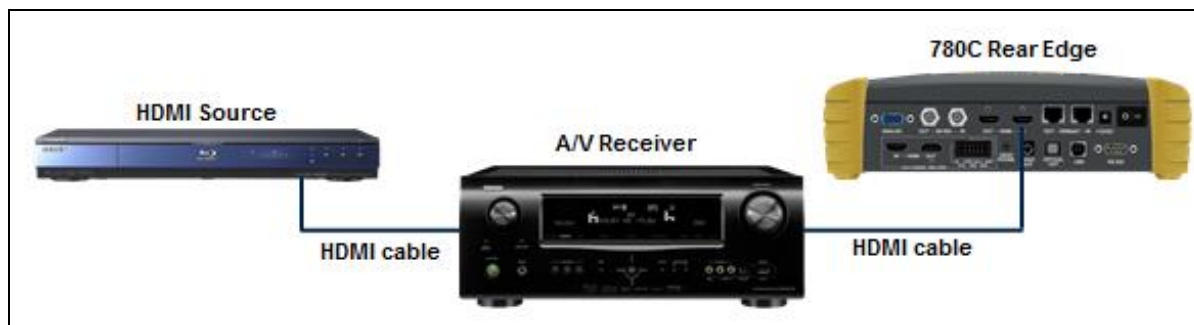
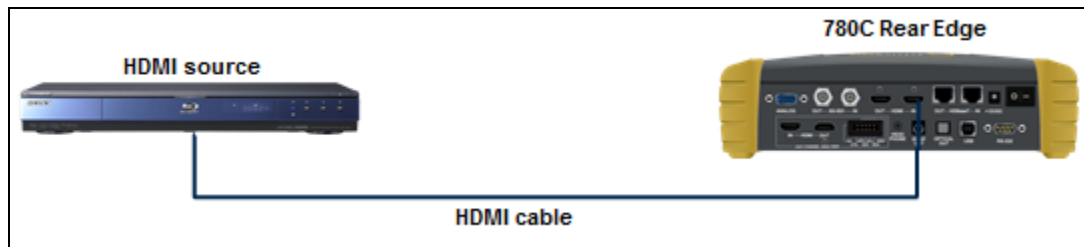
This subsection describes how to test the audio from an HDMI source device.

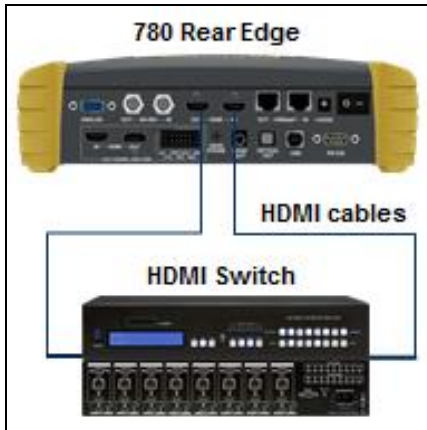
6.4.1 Configurations for Testing Audio on an HDMI Source Device

With the 780C you can run a test on the HDMI audio from a source device. This test shows you the decoded audio IEC header information, the audio infoframes and the audio sample packet header information transmitted from the connected source device which could be a DVD, set top box or the output of an A/V Receiver. You can run this test in three configurations:

- Source device connected directly to the 780C.
- Source device connected to the 780C through a repeater device such as an A/V receiver.
- 780C **HDMI OUT** and **HDMI IN** ports acting as both as a known good source and a known good sink connect to both the input and output of the repeater device.

In all cases the 780C is emulating a sink to test an upstream source. In the third configuration, the 780C is emulating both an HDMI source and sink. These test configurations are shown below.



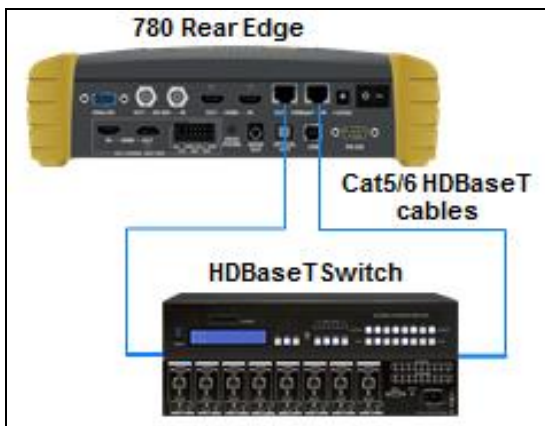


6.4.2 Configurations for Testing Audio on the Output of an HDBaseT Distribution Device

With the 780C you can run a test on the HDMI audio from a source device. This test shows you the decoded audio IEC header information, the audio infoframes and the audio sample packet header information transmitted from the connected source device which could be a DVD, set top box or the output of an A/V Receiver. You can run this test in three configurations:

- Source device connected to the 780C through an HDBaseT distribution device.
- 780C **HDBaseT OUT** and **HDBaseT IN** ports acting as both as a known good source and a known good sink connect to both the input and output of the repeater device.

In all cases the 780C is emulating a sink to test an upstream source. In the third configuration, the 780C is emulating both an HDBaseT source and sink. These test configurations are shown below.



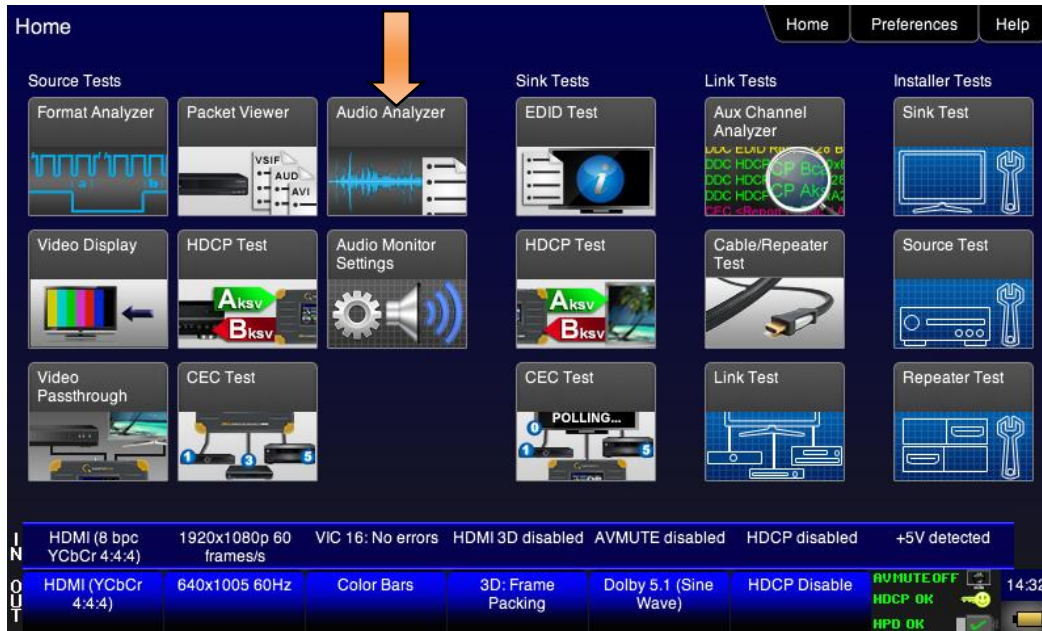
6.4.3 Procedures for Testing Audio from an HDMI/HDBaseT Source Device

Use the following procedures to test the audio from an HDMI source device.

1. Make the physical connection between the 780C **HDMI** or **HDBaseT IN** port and the source device under test using the configuration instructions above.
2. Enable the HDMI or HDBaseT as the active digital interface input.



3. Select **Audio Analyzer** from the **Home** menu shown below.



The **Audio Analysis** screen appears as shown below:



4. Touch select the **Read** activation button to initiate the test.
5. Alternatively you can run this test from the command line as follows:

```
AUDA:RPTP?
```

An example of the results are shown below:

```
Audio InfoFrame data:
Channel count: 2 channels
Coding type: 0 (Refer to stream header)
Word length: Refer to stream header
Sampling freq.: Refer to stream header
Channel allocation:
--- --- --- --- --- --- FR FL
Channel status bits:
Application: Consumer
Sample words: LPCM
Copyright asserted: Yes
Format info: Default
Mode: 0
Category code: 00
Source number: 0
Channel number: 0
Sampling freq.: 48 KHz
Word length: 24 bits)
```

Table 6-2 below describes each field in the Audio Analyzer on-screen report. The audio infoframe information is shown on the left of the resulting screen and the channel status data from the audio sample packets received are displayed on the right.

Table 6-2: Audio Analyzer	
Audio IEC Header decoded data (left side)	Description
Audio Format	Indicates the audio format type. Typically one of: <ul style="list-style-type: none"> ▪ LPCM ▪ Dolby ▪ DTS
Sampling rate	The sampling frequency. One of: <ul style="list-style-type: none"> ▪ Refer to Stream Header ▪ 32kHz ▪ 44.1kHz ▪ 48kHz ▪ 88.2kHz ▪ 96kHz ▪ 176.4kHz ▪ 192kHz
Target bitrate	
Audio Infoframe Data (middle)	Description
Channel count	Indicates the number of active channels. One of: <ul style="list-style-type: none"> ▪ Refer to Stream Header ▪ 2ch ▪ 3ch ▪ 4ch ▪ 5ch ▪ 6ch ▪ 7ch ▪ 8ch
Coding type	Indicates the audio format. One of: <ul style="list-style-type: none"> ▪ Refer to stream header ▪ LPCM (IEC 60958) ▪ AC-3 ▪ MPEG1 ▪ MPEG2 ▪ AAC ▪ DTS ▪ ATRAC ▪ One Bit Audio ▪ Dolby Digital Plus ▪ DTS-HD ▪ MAT ▪ DST ▪ WMA Pro
Sample Size	The sample size or bit depth. One of: <ul style="list-style-type: none"> ▪ Refer to Stream Header ▪ 16 bit ▪ 20 bit ▪ 24 bit

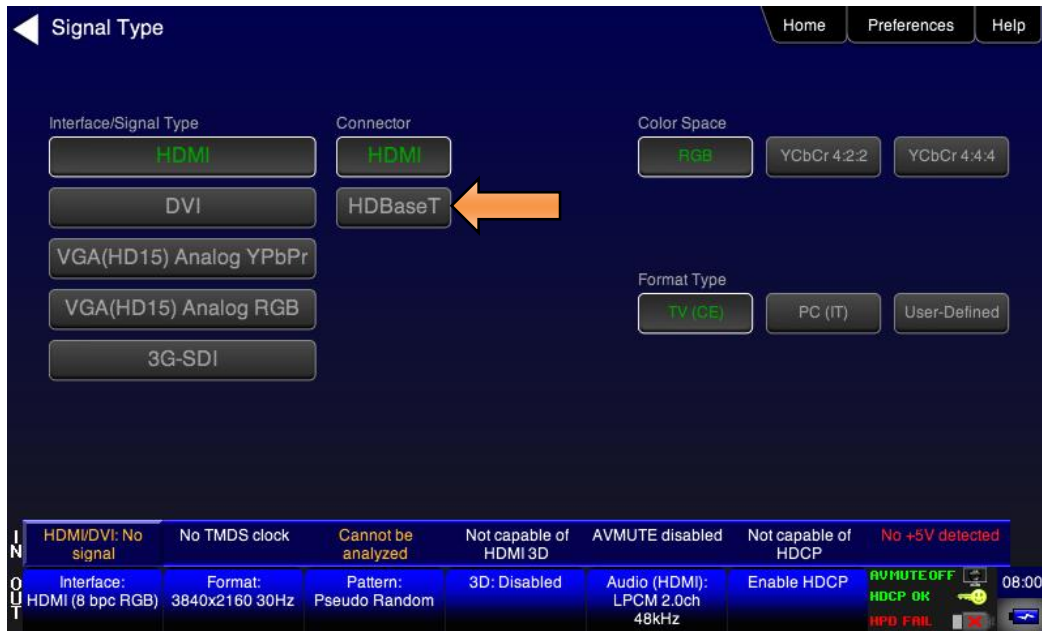
Table 6-2: Audio Analyzer	
Audio IEC Header decoded data (left side)	Description
Sampling Frequency	The sampling frequency. One of: <ul style="list-style-type: none"> ▪ Refer to Stream Header ▪ 32kHz ▪ 44.1kHz ▪ 48kHz ▪ 88.2kHz ▪ 96kHz ▪ 176.4kHz ▪ 192kHz
Channel Allocation	The speaker mapping and allocation. One or more of the following: <ul style="list-style-type: none"> ▪ FL ▪ FC ▪ FR ▪ RLC ▪ FRC ▪ RL ▪ RC ▪ RR ▪ RLC ▪ RRC ▪ LFE
Audio Clock Regeneration N/ CTS values	<ul style="list-style-type: none"> ▪ N ▪ CTS
Channel Status Bit Data (right side)	Description
Application	Application format. One of: Consumer or Professional.
Sample words	Sample word encoding. One of: LPCM or Encoded (non linear compressed).
Copyright asserted	Copyright assertion. One of: Yes or No.
Format info	Format. Typically Default.
Mode	Channel mode. Typically 0 for Mode 0.
Category code	Category code. Typically 00 for general.
Source number	Source number. Typically 0 for Unspecified.
Channel number	Channel number. Typically 0 for Unspecified
Sampling freq	Sampling rate. One of: <ul style="list-style-type: none"> ▪ 32kHz ▪ 44.1kHz ▪ 48kHz ▪ 88.2kHz ▪ 96kHz ▪ 176.4kHz ▪ 192kHz

Table 6-2: Audio Analyzer	
Audio IEC Header decoded data (left side)	Description
Word length	Audio word length. One of: <ul style="list-style-type: none"> ▪ 16 bit ▪ 20 bit ▪ 24 bit

6.4.4 Procedures for Testing Audio from an HDMI/HDBaseT Source Device

Use the following procedures to test the audio from an HDMI source device.

6. Make the physical connection between the 780C **HDMI** or **HDBaseT IN** port and the source device under test using the configuration instructions above.
7. Enable the HDMI or HDBaseT as the active digital interface input.



8. Select **Audio Analyzer** from the **Home** menu shown below.



The **Audio Analysis** screen appears as shown below:



9. Touch select the **Read** activation button to initiate the test.
10. Alternatively you can run this test from the command line as follows:

```
AUDA:RTPP?
```

An example of the results are shown below:

```
Audio InfoFrame data:
Channel count: 2 channels
Coding type: 0 (Refer to stream header)
```

Word length: Refer to stream header
Sampling freq.: Refer to stream header
Channel allocation:
--- --- --- --- --- --- FR FL
Channel status bits:
Application: Consumer
Sample words: LPCM
Copyright asserted: Yes
Format info: Default
Mode: 0
Category code: 00
Source number: 0
Channel number: 0
Sampling freq.: 48 KHz
Word length: 24 bits)

Table 6-2 below describes each field in the Audio Analyzer on-screen report. The audio infoframe information is shown on the left of the resulting screen and the channel status data from the audio sample packets received are displayed on the right.

Table 6-2: Audio Analyzer	
Audio IEC Header decoded data (left side)	Description
Audio Format	Indicates the audio format type. Typically one of: <ul style="list-style-type: none"> ▪ LPCM ▪ Dolby ▪ DTS
Sampling rate	The sampling frequency. One of: <ul style="list-style-type: none"> ▪ Refer to Stream Header ▪ 32kHz ▪ 44.1kHz ▪ 48kHz ▪ 88.2kHz ▪ 96kHz ▪ 176.4kHz ▪ 192kHz
Target bitrate	
Audio Infoframe Data (middle)	Description
Channel count	Indicates the number of active channels. One of: <ul style="list-style-type: none"> ▪ Refer to Stream Header ▪ 2ch ▪ 3ch ▪ 4ch ▪ 5ch ▪ 6ch ▪ 7ch ▪ 8ch
Coding type	Indicates the audio format. One of: <ul style="list-style-type: none"> ▪ Refer to stream header ▪ LPCM (IEC 60958) ▪ AC-3 ▪ MPEG1 ▪ MPEG2 ▪ AAC ▪ DTS ▪ ATRAC ▪ One Bit Audio ▪ Dolby Digital Plus ▪ DTS-HD ▪ MAT ▪ DST ▪ WMA Pro
Sample Size	The sample size or bit depth. One of: <ul style="list-style-type: none"> ▪ Refer to Stream Header ▪ 16 bit ▪ 20 bit ▪ 24 bit

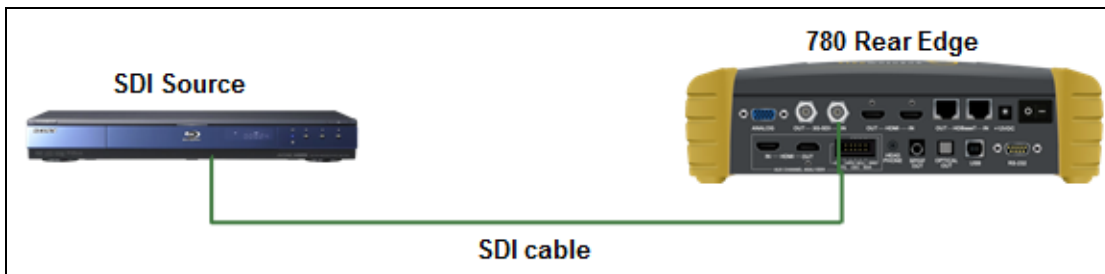
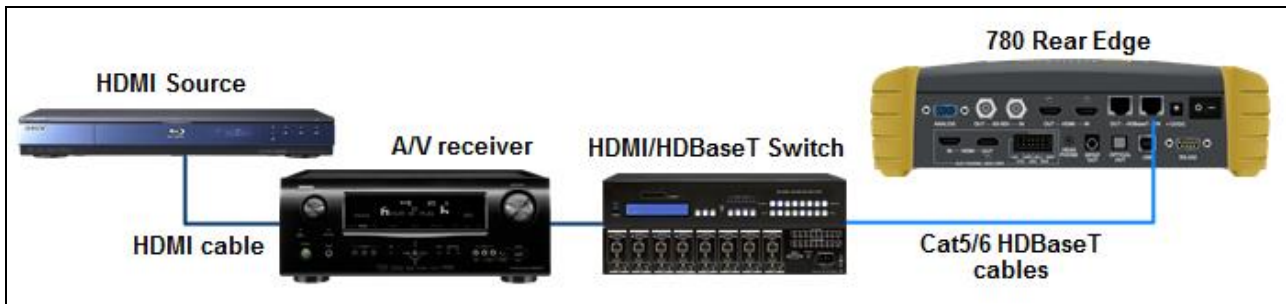
Table 6-2: Audio Analyzer	
Audio IEC Header decoded data (left side)	Description
Sampling Frequency	The sampling frequency. One of: <ul style="list-style-type: none"> ▪ Refer to Stream Header ▪ 32kHz ▪ 44.1kHz ▪ 48kHz ▪ 88.2kHz ▪ 96kHz ▪ 176.4kHz ▪ 192kHz
Channel Allocation	The speaker mapping and allocation. One or more of the following: <ul style="list-style-type: none"> ▪ FL ▪ FC ▪ FR ▪ RLC ▪ FRC ▪ RL ▪ RC ▪ RR ▪ RLC ▪ RRC ▪ LFE
Audio Clock Regeneration N/ CTS values	<ul style="list-style-type: none"> ▪ N ▪ CTS
Channel Status Bit Data (right side)	Description
Application	Application format. One of: Consumer or Professional.
Sample words	Sample word encoding. One of: LPCM or Encoded (non linear compressed).
Copyright asserted	Copyright assertion. One of: Yes or No.
Format info	Format. Typically Default.
Mode	Channel mode. Typically 0 for Mode 0.
Category code	Category code. Typically 00 for general.
Source number	Source number. Typically 0 for Unspecified.
Channel number	Channel number. Typically 0 for Unspecified
Sampling freq	Sampling rate. One of: <ul style="list-style-type: none"> ▪ 32kHz ▪ 44.1kHz ▪ 48kHz ▪ 88.2kHz ▪ 96kHz ▪ 176.4kHz ▪ 192kHz

Table 6-2: Audio Analyzer	
Audio IEC Header decoded data (left side)	Description
Word length	Audio word length. One of: <ul style="list-style-type: none"> ▪ 16 bit ▪ 20 bit ▪ 24 bit

6.4.5 Procedures for Audible Monitoring of LPCM Audio from an Digital Video Source Device

You can monitor the incoming stereo LPCM audio on the HDMI, HDBaseT or SDI IN port at the headphone jack on the front edge of the 780C. You can also monitor a single channel of LPCM audio through the embedded speaker. You can select what channels of a multi-channel LPCM to monitor on the stereo headphone jack or which single channel on the speaker using the screens provided. Use the following procedures to configure the audio monitoring of the incoming LPCM audio through the headphone jack and embedded speaker.

1. Connect the HDMI system devices to the 780C as shown in the diagrams below. The HDMI source device output is connected the 780C **HDMI, HDBaseT or SDI IN** connector is the audio is routed through an HDBaseT distribution device. Refer to the diagrams below:



2. Touch select **Audio Monitor Settings** from the **Home** menu shown below.



The following screen appears:



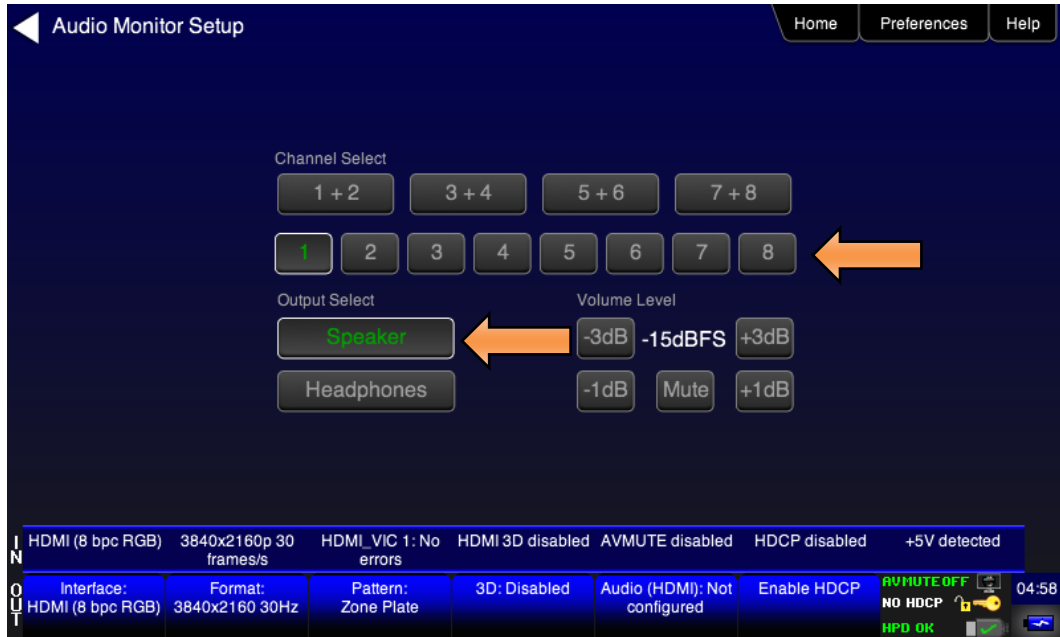
3. Select the pair of channels to monitor through the headphone jack using the **Headphone Channels** set of selection buttons.



4. Specify the Headphone amplitude in increments of +/-3dB or =/-1dB using the buttons under **Headphone Level**. Select **Mute** to extinguish the audio.



5. Select the single channel to monitor through the embedded speaker using the **Speaker Channel** set of selection buttons.



- 6. Specify the speaker amplitude in increments of +/-3dB or +/-1dB using the buttons under **Speaker Level**. Select **Mute** to extinguish the audio.



6.5 Testing an HDMI or HDBaseT Source's Response to EDIDs

The 780C HDMI and HDBaseT IN ports emulate an HDMI or HDBaseT sink device. Part of that emulation function is presenting an EDID to a source when a sink device is powered and hot plug is asserted. The 780C is provisioned with a default EDID from the factory. There are two standard EDIDs available with the 780C as provided: 1) Standard HDTV EDID, 2) Standard A/V Receiver EDID.

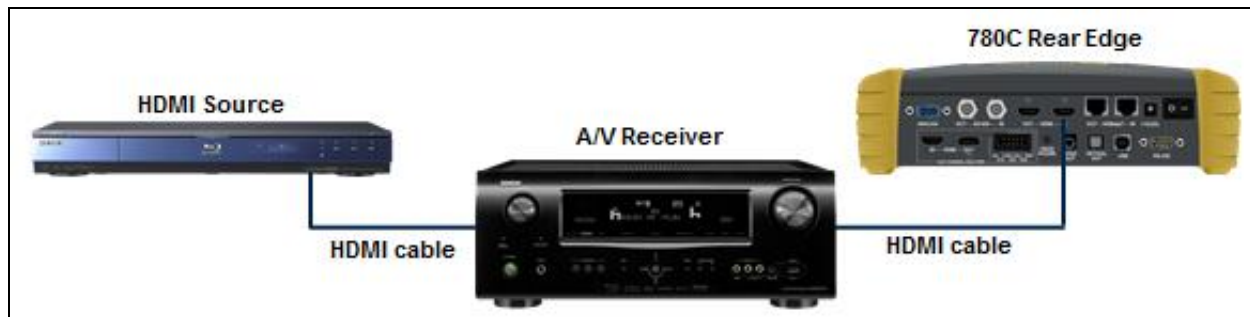
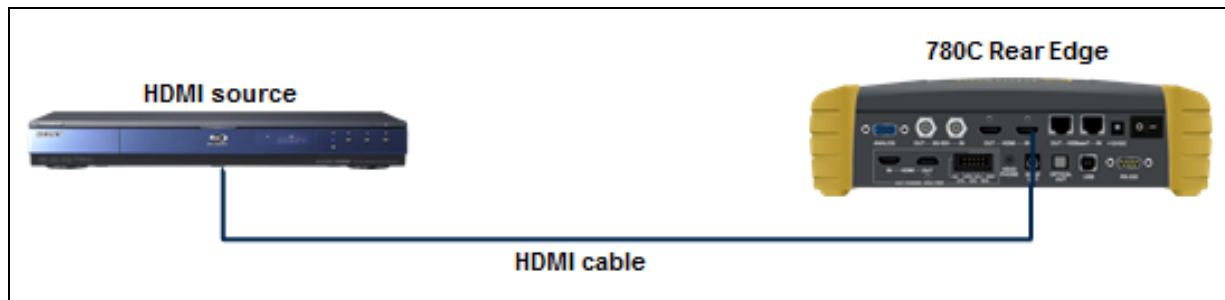
However you can reprogram the EDID by connecting it to a sink device whose EDID you would like to use for testing. The 780C can store multiple EDIDs. These EDIDs can be obtained either by extracting them from an HDMI or HDBaseT sink device (e.g. HDTV, Projector, AVR, repeater or distribution device input) or by importing EDID .xml files created using Quantum Data EDID Editor tools. For procedures on importing EDIDs refer to [Adding Reference EDIDs for Use in Testing HDMI Devices](#).

Note: Quantum Data has an EDID Library available for free at: <http://www.quantumdata.com/edid/>.

The EDID test of an HDMI or HDBaseT source device enables you to see how a source device responds to a specific EDID or a series of EDIDs. The EDID could be a known good EDID or an EDID you have chosen specifically for testing purposes.

6.5.1 Configurations for Testing an HDMI Source Device's Response to an EDID

You can run this test in two configurations: 1) with your source device connected directly to the 780C, 2) with your source device connected to the 780C through a repeater device. In both cases the 780C is emulating an HDMI sink to test an upstream source. These configurations are shown below.



6.5.2 Configurations for Testing an HDBaseT Device's Output Response to an EDID

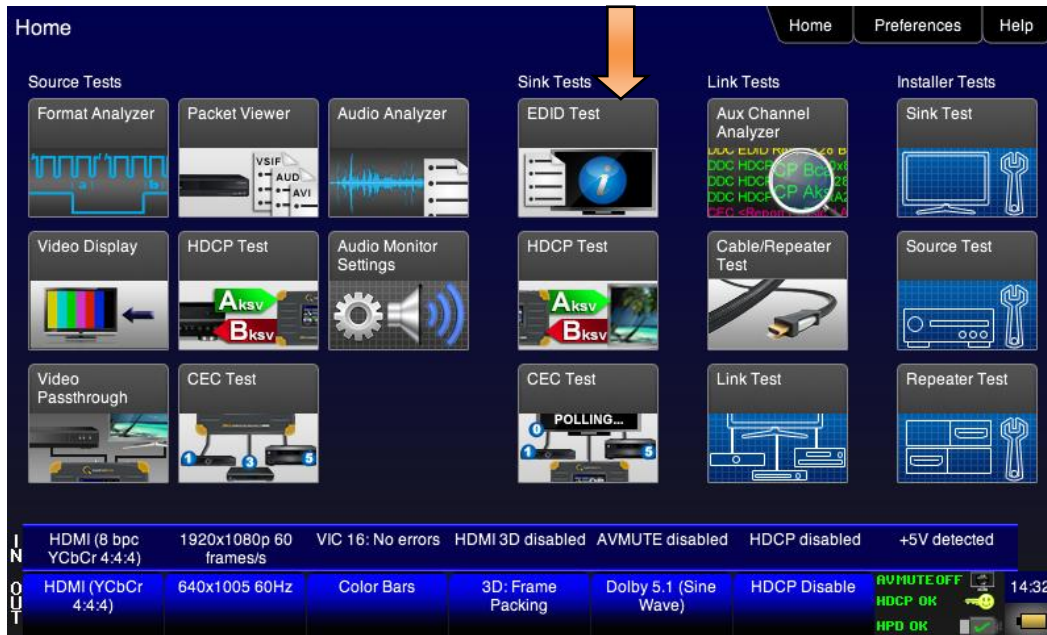
Typically you run this test with the 780C connected to an HDMI source through an HDBaseT distribution device. This configuration is shown below.



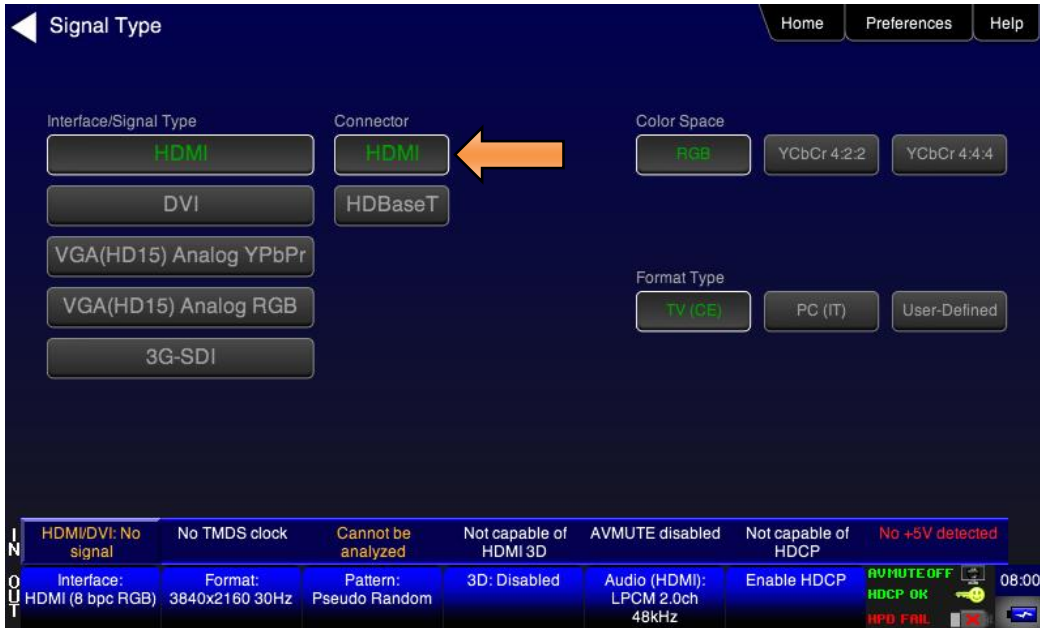
6.5.3 Procedures for Testing an HDMI Source Devices Response to an EDID

Use the following procedures to test the EDID response from an HDMI source device.

1. Touch select EDID Test from the Home menu (shown below).



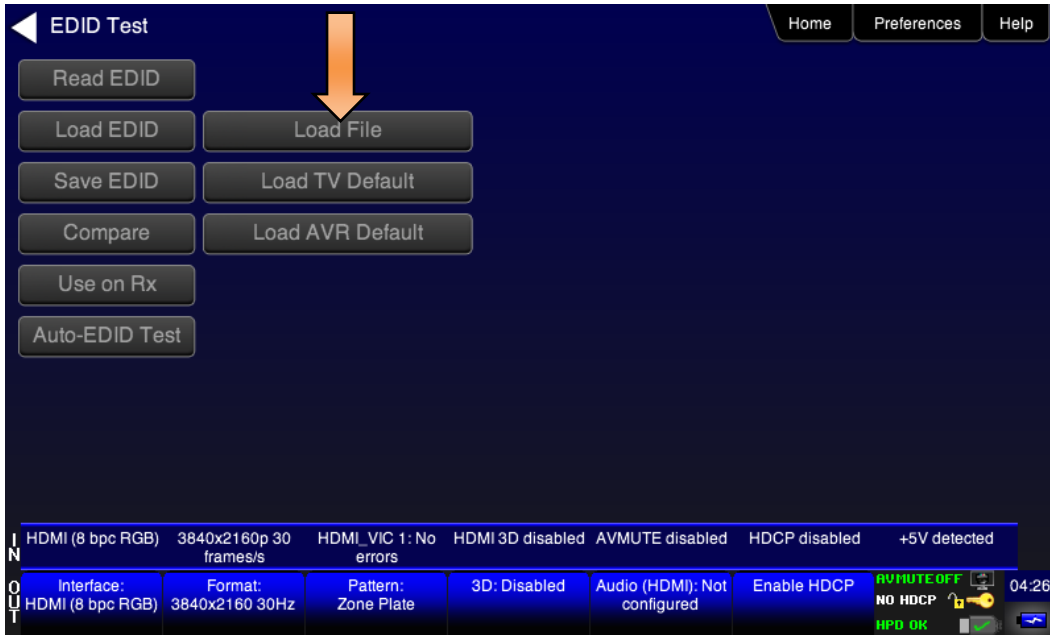
2. Enable the HDMI or HDBaseT as the active digital interface input.



The following menu appears.



3. Touch select Load from the EDID Tests menu. The following screen results.



The options:

- Load File – Loads from an EDID file stored on the 780C file system
 - Load TV Default – Loads the standard reference EDID for a TV from the 780C file system
 - Load AVR Default - Loads the standard reference EDID for a AVR from the 780C file system
4. If you have selected the Load File option, the following screen results. Select the file that you wish to use as the reference EDID. In the example below there is only one file.

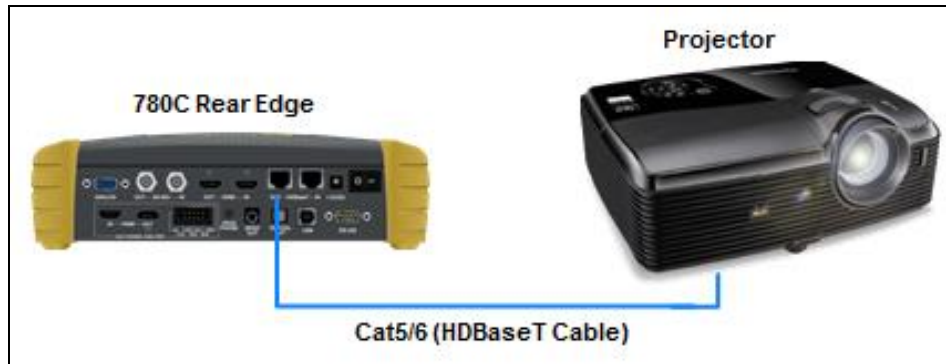
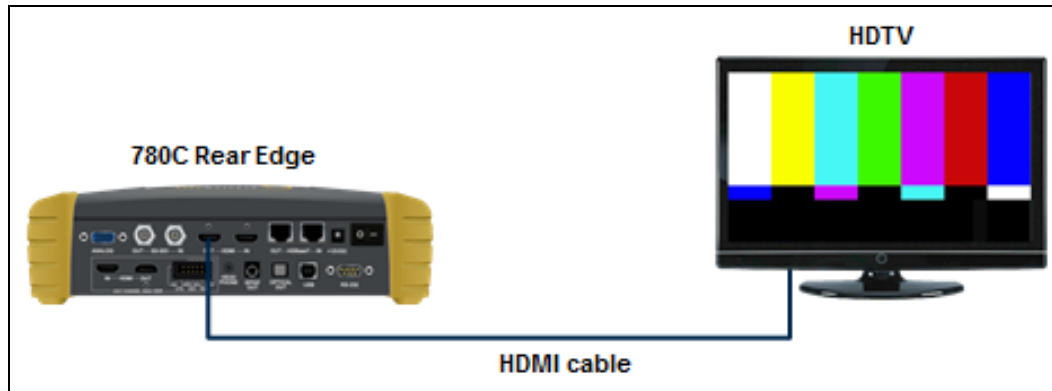


The EDID is loaded and displayed on the screen.



- If you wish to obtain an EDID from an HDMI or HDBaseT sink device that you have on hand, connect the 780C HDMI or HDBaseT OUT port to the HDMI/HDBaseT input of that sink device. This configuration is depicted below.

Skip to Step 8 if you do not want to use an EDID from an HDMI/HDBaseT sink device you have on hand.



- Navigate to the EDID Test from the Sink Tests menu shown below.

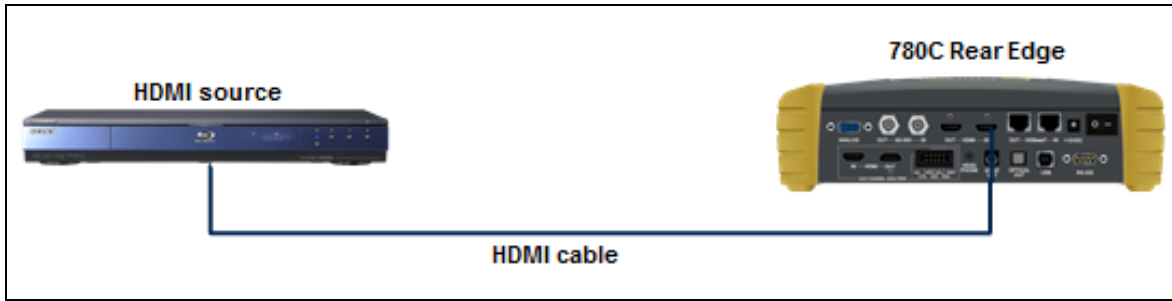


7. Touch select the Read activation button from the EDID Test menu shown above.
The EDID is listed as shown below.



8. Touch select the Use on Rx activation button to apply the EDID, you have either loaded from a file or read from an HDMI/HDBaseT sink device, to the 780C **HDMI** or **HDBaseT IN** port.
9. Connect the 780C **HDMI IN** or **HDBaseT IN** port to the HDMI output of a source device or HDBaseT output you wish to test as shown in the illustration below.

This will cause a hot plug event and the source device under test should read the EDID of the 780C **HDMI IN** or **HDBaseT IN** port. Run the Format Analyzer test and other diagnostic tests on the source to determine how it responded to the EDID.



7 Using the 780C Test Instrument Installer Test Utility

This section provides procedures for diagnosing HDMI and HDBaseT networks using the automated Installer Test. **The features and functions described in this section are included as a standard feature.** The Installer Test enables you to quickly and simply identify common interoperability problems. The Installer Test enables you to conduct step by step diagnostics toward the source—upstream (**Source Test**), toward the sink—downstream (**Sink Test**), or in a looped configuration around a repeater device (**Repeater Test**). You can also conduct both an upstream and a downstream diagnostic test at the same time using the **Link Test**.

Table 7-1 below describes what items are tested with each test in the Installer Test.

Table 7-1: Installer Test	
Sink Test	Description
	<ul style="list-style-type: none"> ▪ Verifies hot plug detect is high ▪ Verifies EDID (bad header, bad checksum, pass/fail on compliance) ▪ Runs an HDCP test ▪ Runs a video test at EDID preferred timing, with HDCP enabled ▪ Test EDID video at 1080p(24/50/60), 1080i(25/30), 720p(50/60) ▪ YCbCr 4:2:0 4:2:2 and 4:4:4 video tests ▪ Tests deep color parameters ▪ Test port switch on HDTV with HDCP re-authentication
Source Test	Description
	<ul style="list-style-type: none"> ▪ Tests the maximum number of HDCP keys supported by the source device during HDCP authentication. ▪ Verifies the incoming video at various timings ▪ Verifies video timing parameters.

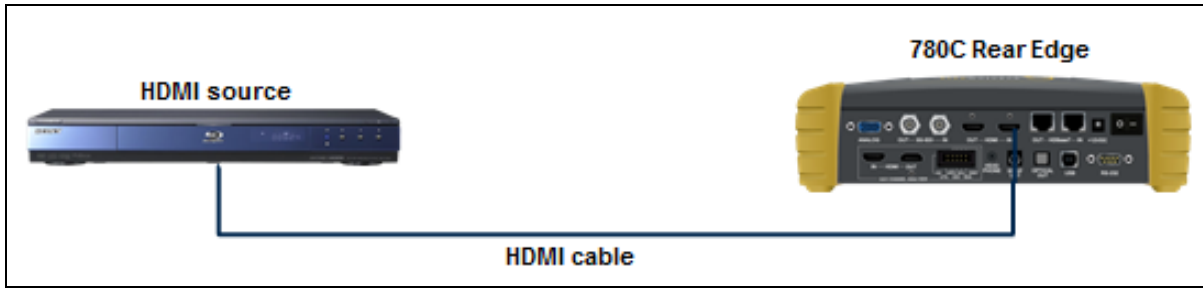
Repeater Test	Description
	<ul style="list-style-type: none"> ▪ Verifies hot plug detect is asserted. ▪ Verifies EDID (bad header, bad checksum, pass/fail on compliance) ▪ Indicates if the EDID was modified. ▪ Verifies timing pass-through. ▪ Checks if video was passed through unchanged or not. ▪ If timing is passed through, test will also verify if the video is passed through without color manipulation. ▪ Verifies HDCP authentication and if repeater acts as an HDCP repeater or not and verifies that it acts properly as an HDCP repeater. ▪ Test port switch on HDTV with HDCP re-authentication
Link Test	Description
	<ul style="list-style-type: none"> ▪ Tests the maximum number of HDCP keys (max dev count) supported by the source device during HDCP authentication. ▪ Verifies hot plug detect is asserted. ▪ Verifies EDID (bad header, bad checksum, pass/fail on compliance). ▪ Runs an HDCP authentication test on both source and sink. ▪ Runs a video test at EDID preferred timing, with HDCP enabled. ▪ Test port switch on HDTV with HDCP re-authentication ▪ Verifies the incoming video at various timings ▪ Verifies video timing parameters.

7.1 Diagnosing HDMI and HDBaseT Interoperability Problems toward the Source - Upstream

This subsection describes how to diagnose HDMI and HDBaseT interoperability problems on HDMI/HDBaseT source device—upstream (Source Test).

7.1.1 Connection Configurations for Testing HDMI Source Devices

The 780C's HDMI input port acts as a "reference" HDMI sink device. Therefore it enables you to emulate a known good HDMI sink device to conduct diagnostics upstream toward the source device. The following illustrations show the typical configurations.



7.1.2 Connection Configurations for Testing HDBaseT Source Devices

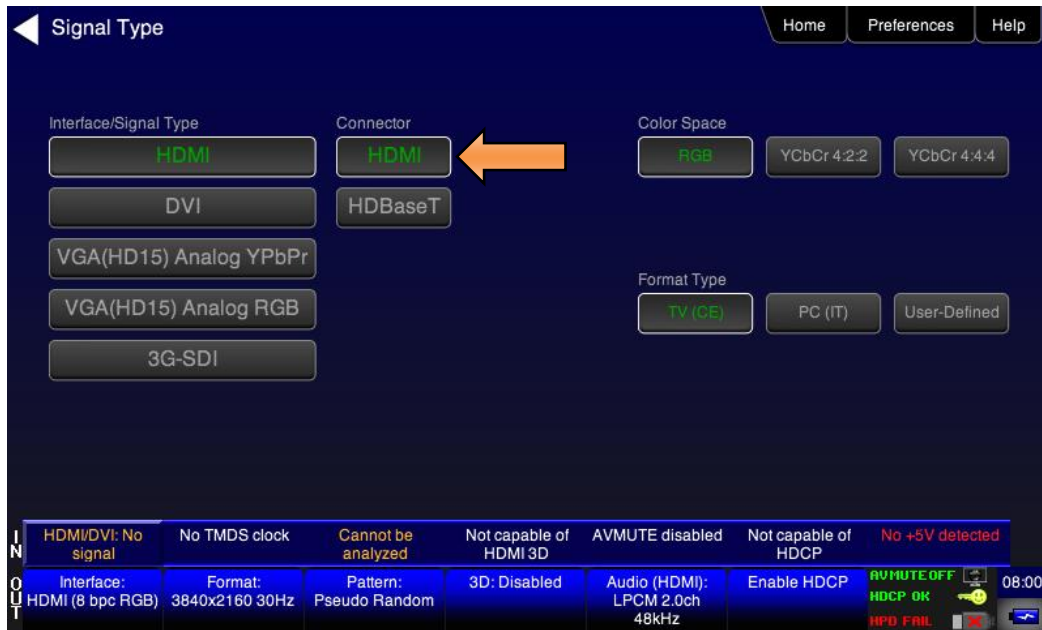
The 780C's HDBaseT input port acts as a “reference” HDBaseT sink device. Therefore it enables you to emulate a known good HDBaseT sink device to conduct diagnostics upstream toward the source device. The following illustrations show the typical configurations.



7.1.3 Procedures for Testing Upstream (Source Test) with the Installer Utility

Use the following procedures to test the video from an HDMI source device directly at the HDMI source or through an HDMI repeater device or HDBaseT distribution device. You can view the incoming video and check the video and timing parameters of the incoming video.

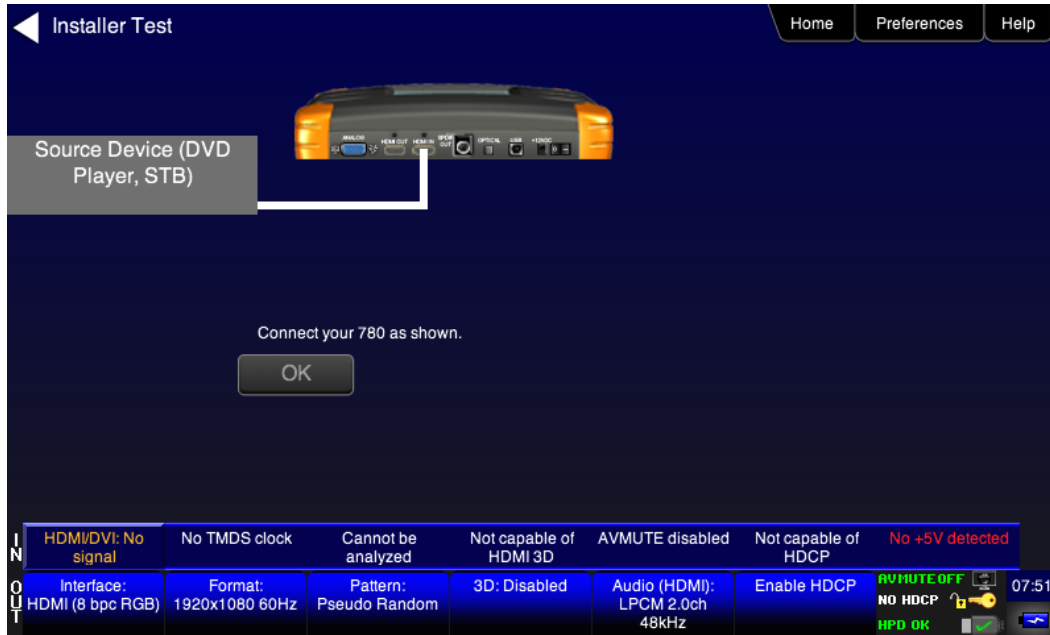
1. Make the physical connection between the 780C **HDMI IN** or HDBaseT IN port and the upstream device under test using the configuration instructions above or by following the instructions on the screen.
2. Enable the HDMI or HDBaseT as the active digital interface input.



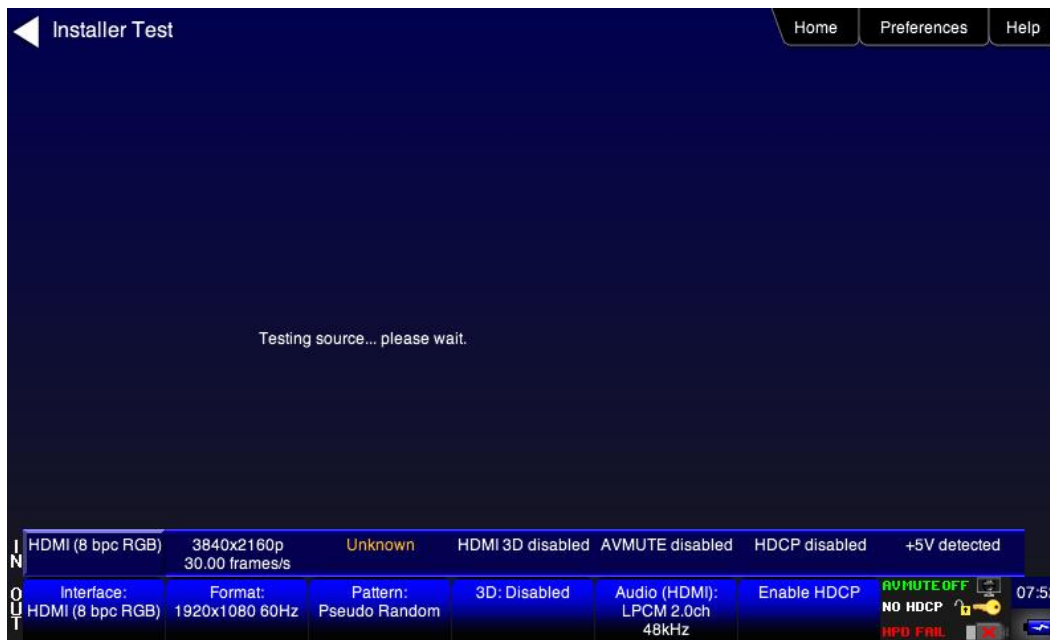
3. Touch select **Source Test** under **Installer Tests** from the **Home** menu shown below.



4. Touch select the **OK** activation button to initiate the test.



The test will run for up to about a minute. A status screen is provided as shown below.



You will be asked to verify the video and video parameters presented on the 780C display. Touch select the appropriate activation button **Yes** or **No**.

A sample of a results screen is shown below.

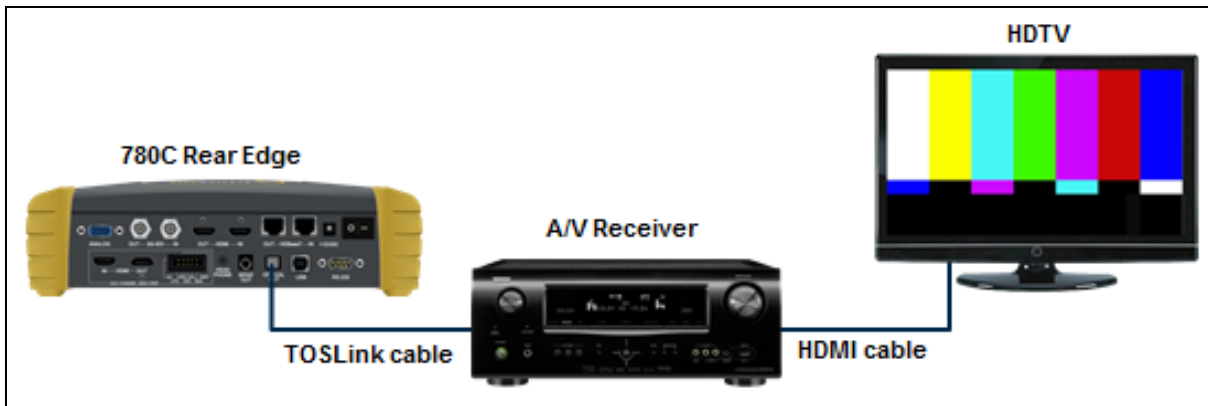
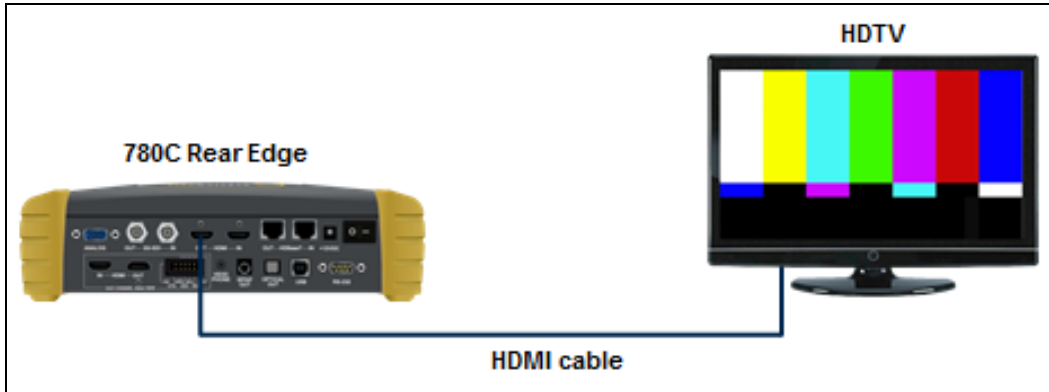


7.2 Diagnosing HDMI and HDBaseT Interoperability Problems at the Sink - Downstream

This subsection describes how to diagnose HDMI and HDBaseT interoperability problems on HDMI or HDBaseT sink device—downstream (**Sink Test**).

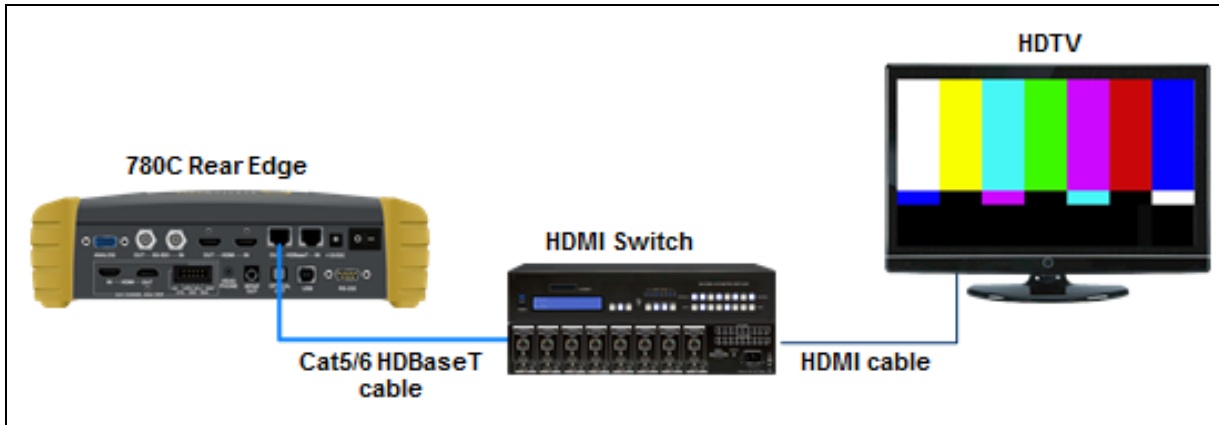
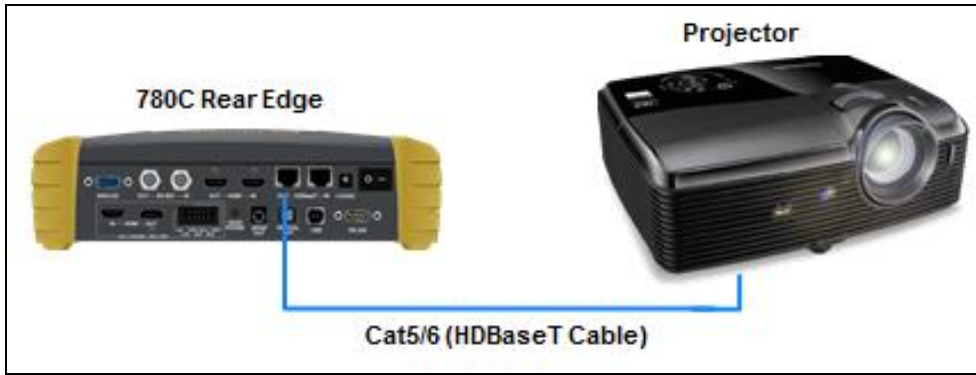
7.2.1 Connection Configurations for Testing HDMI Sink Devices

The 780C’s HDMI input port acts as a “reference” HDMI source device. Therefore it enables you to emulate a known good HDMI source device to conduct diagnostics downstream toward the sink device. The following illustrations show the typical configurations.



7.2.2 Connection Configurations for Testing HDBaseT Sink Devices

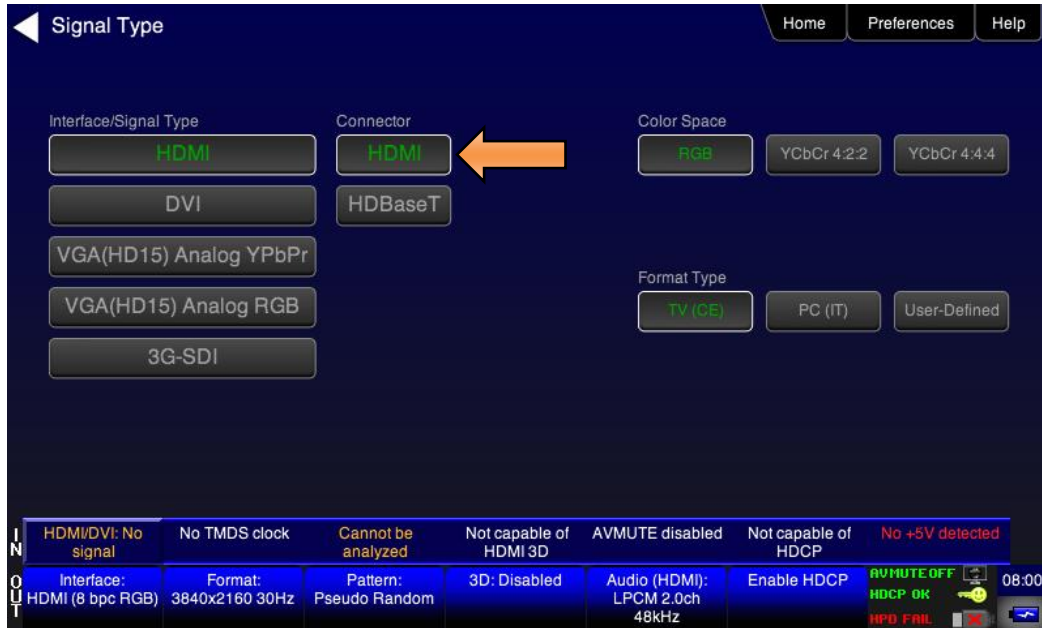
The 780C’s HDBaseT output port acts as a “reference” HDBaseT source device. Therefore it enables you to emulate a known good HDBaseT source device to conduct diagnostics downstream toward the sink device. The following illustrations show the typical configurations.



7.2.3 Procedures for Testing Downstream (Sink Test) with the Installer Utility

Use the following procedures to test the video from an HDMI sink device.

1. Make the physical connection between the 780C **HDMI/HDBaseT OUT** port and the sink device under test using the configuration instructions above or by following the instructions on the screen.
2. Enable the HDMI or HDBaseT as the active digital interface input.



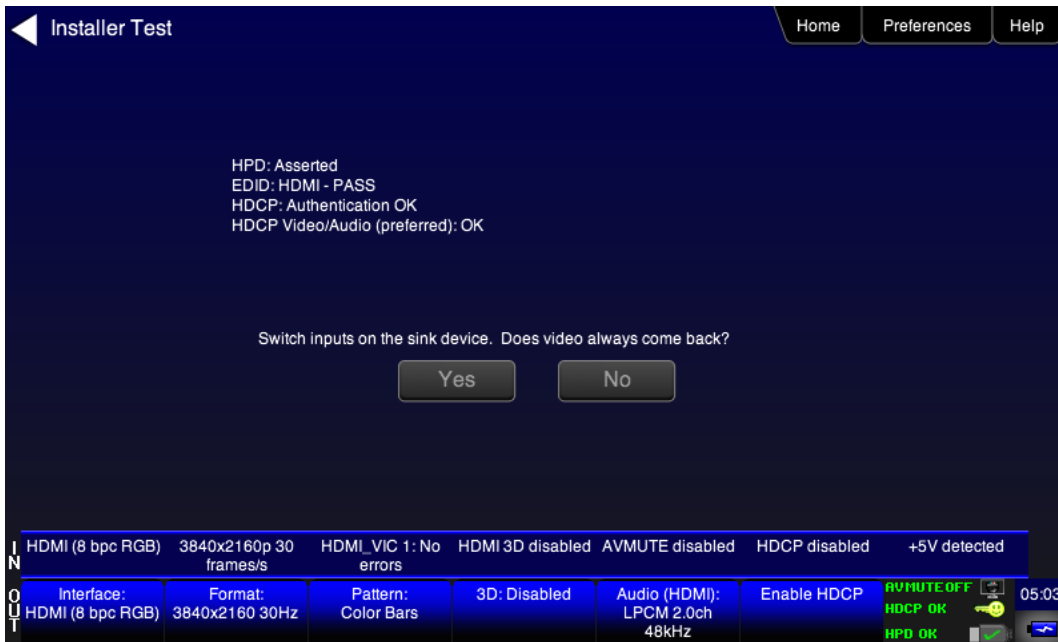
3. Touch select **Sink Test** under the **Installer Tests** from the **Home** menu shown below.



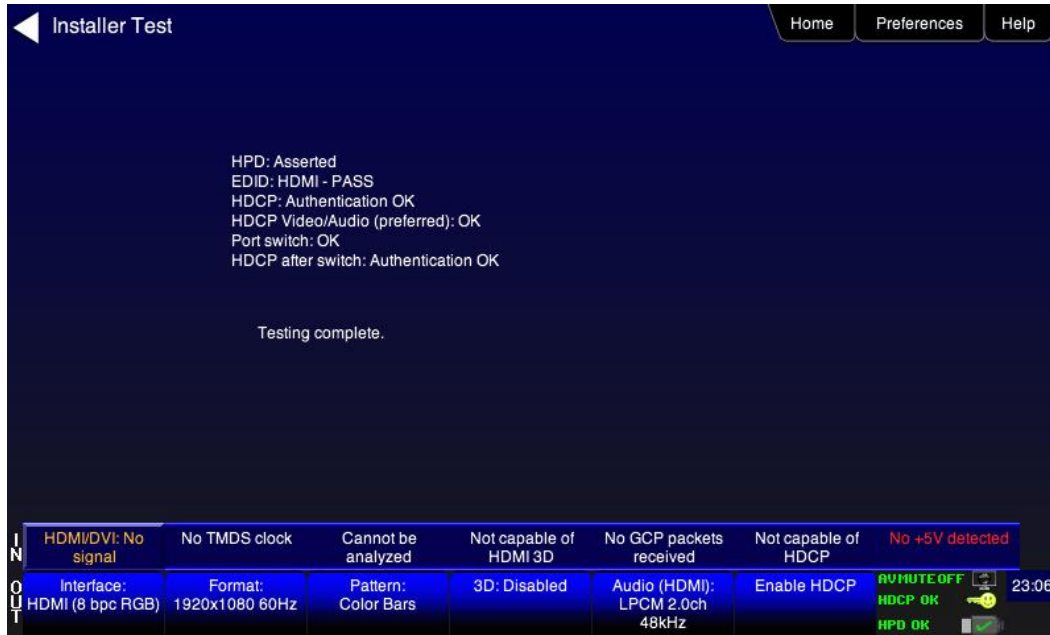
4. Touch select the **OK** activation button to initiate the test.



The test will run for up to about a minute. You will be asked to verify the video and video parameters presented on the display device under test. Touch select the appropriate activation button **Yes** or **No**.



The results are presented for each timing (video resolution) tested. The following two screens are samples of these results screens.

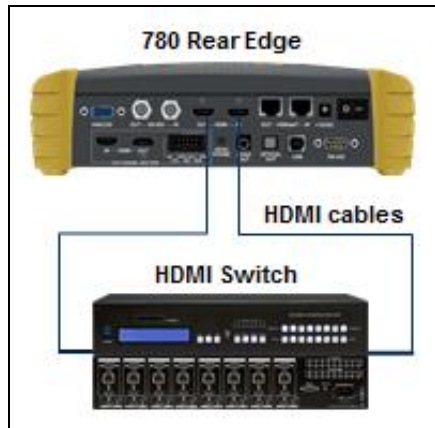


7.3 Diagnosing HDMI/HDBaseT Interoperability Problems with a Repeater

This subsection describes how to diagnose HDMI/HDBaseT interoperability problems related to an HDMI/HDBaseT repeater device (**Repeater Test**).

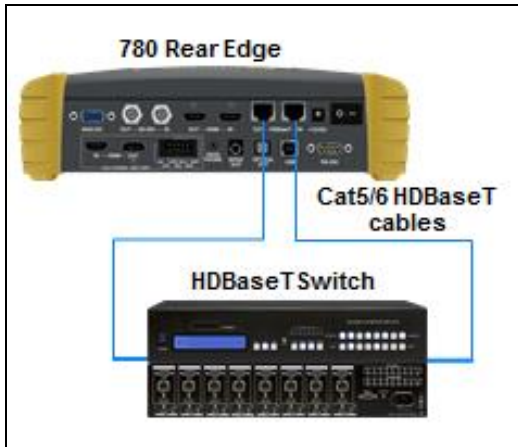
7.3.1 Connection Configurations for Testing HDMI Repeater Devices

The 780C’s HDMI input port acts as a “reference” HDMI source and sink device simultaneously. Therefore it enables you to emulate both a known good HDMI source and sink device to conduct diagnostics on a repeater device. The following illustration shows the typical configuration.



7.3.2 Connection Configurations for Testing HDBaseT Repeater Devices

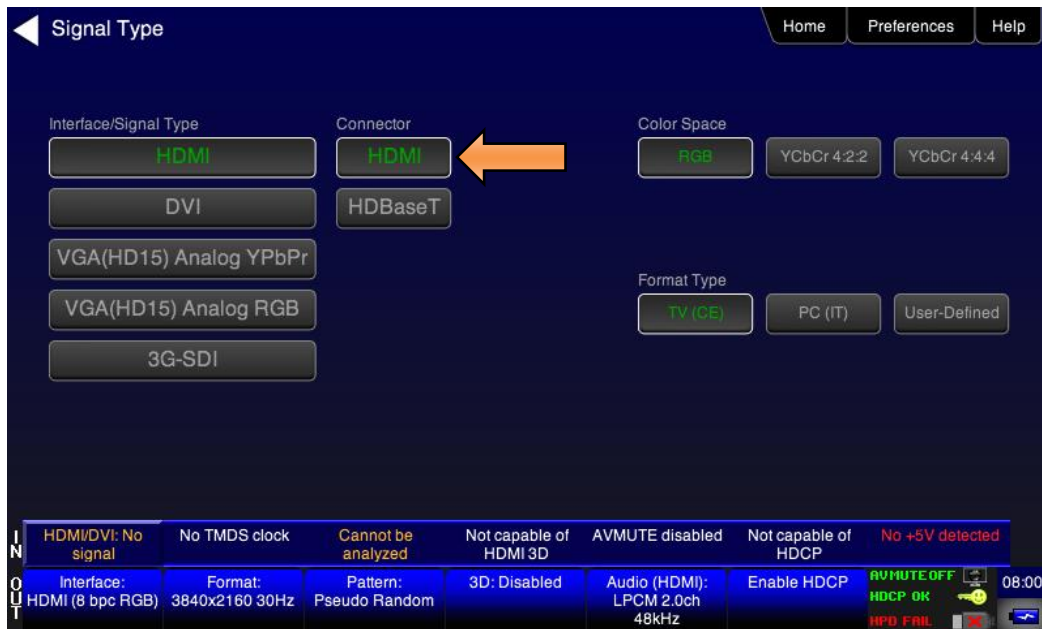
The 780C’s HDBaseT input port acts as a “reference” HDBaseT source and sink device simultaneously. Therefore it enables you to emulate both a known good HDBaseT source and sink device to conduct diagnostics on a repeater device. The following illustration shows the typical configuration.



7.3.3 Procedures for Testing Repeaters (Repeater Test) with the Installer Utility

Use the following procedures to test the video from an HDMI/HDBaseT repeater device with the Installer Utility.

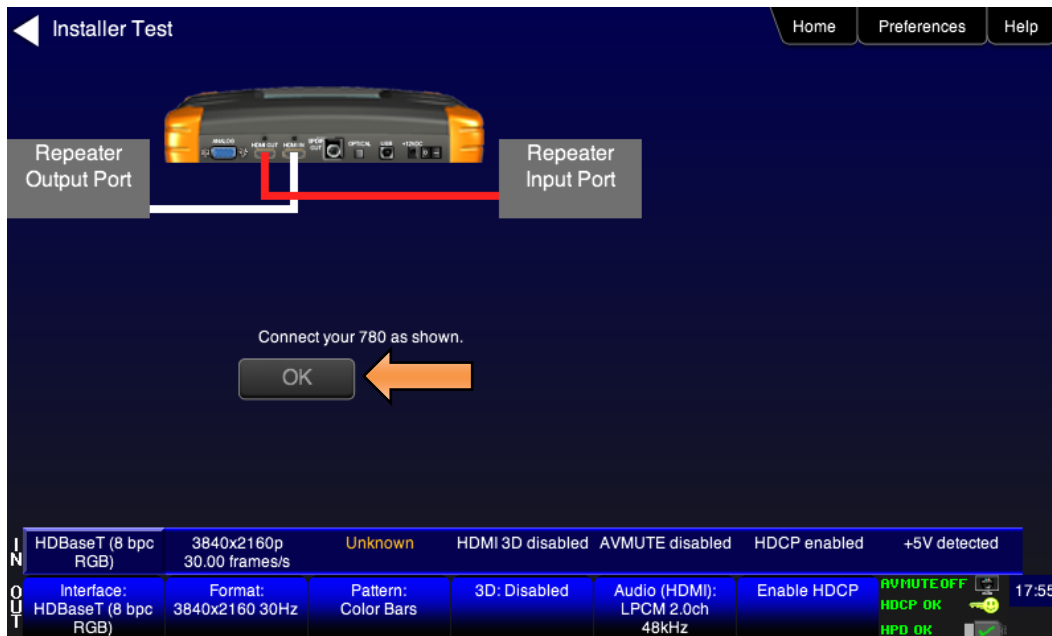
1. Make the physical connections between the 780C HDMI/HDBaseT IN and OUT ports and the sink device under test using the configuration instructions above or by following the instructions on the screen.
2. Enable the HDMI or HDBaseT as the active digital interface input as shown below.



3. Touch select **Repeater Test** from **Installer Tests** from the **Home** menu shown below.

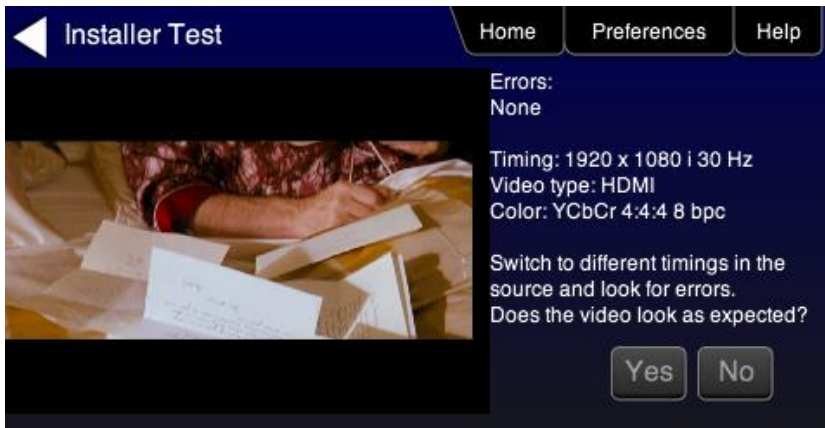
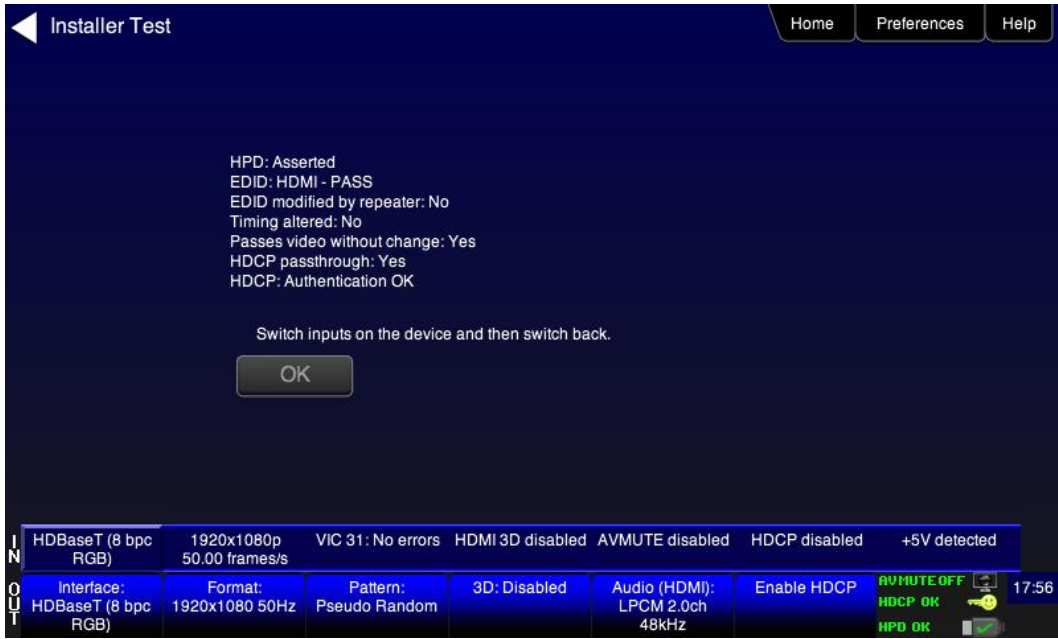


The Repeater Test screen will appear as shown below.

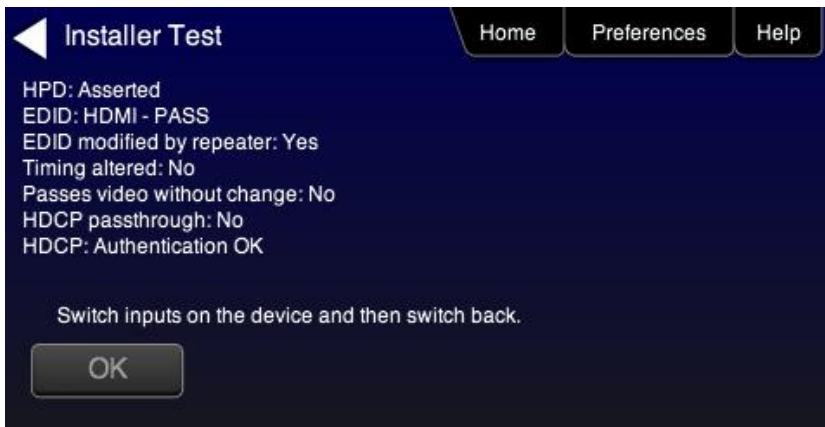


4. Touch select the **OK** activation button to initiate the test.

The test will run for up to about a minute. You will be instructed to switch to different timings and verify that the video displayed on the 780C screen looks correct.



The results are presented for each timing (video resolution) tested. The following screen is a sample of these results.

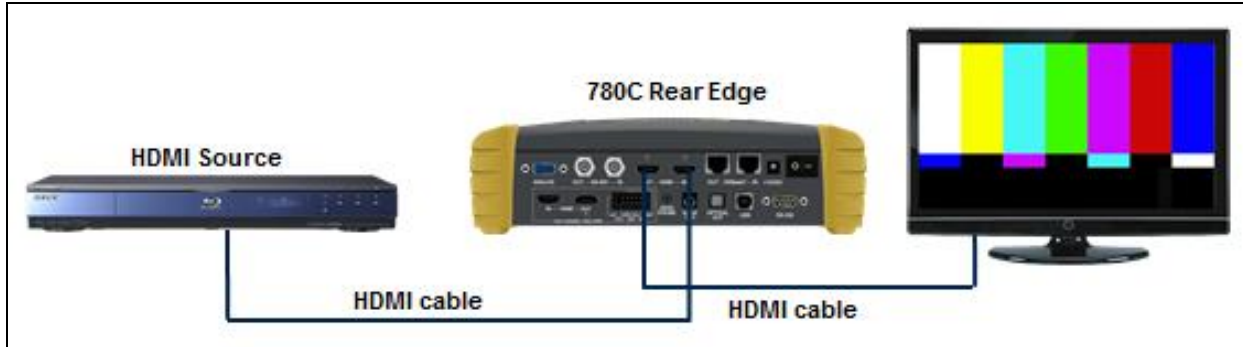


7.4 Diagnosing HDMI/HDBaseT Interoperability Problems in an HDMI/HDBaseT Network

This subsection describes how to diagnose HDMI interoperability problems in an HDMI network (**Link Test**).

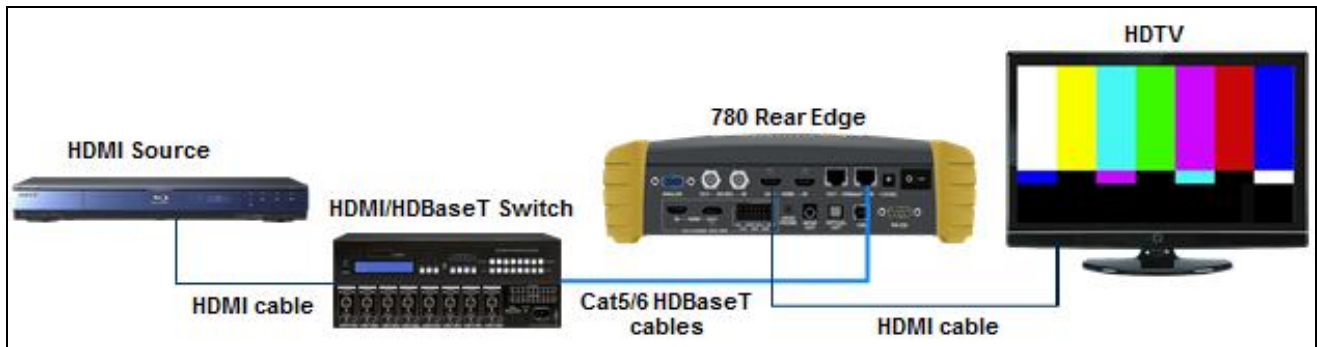
7.4.1 Connection Configurations for Testing HDMI Links

The 780C's HDMI input port acts as a "reference" HDMI source and sink device simultaneously. Therefore it enables you to emulate both a known good HDMI source and sink device to conduct diagnostics on a source devices upstream and sink devices downstream simultaneously. The following illustration shows the typical configuration.



7.4.2 Connection Configurations for Testing HDBaseT Links

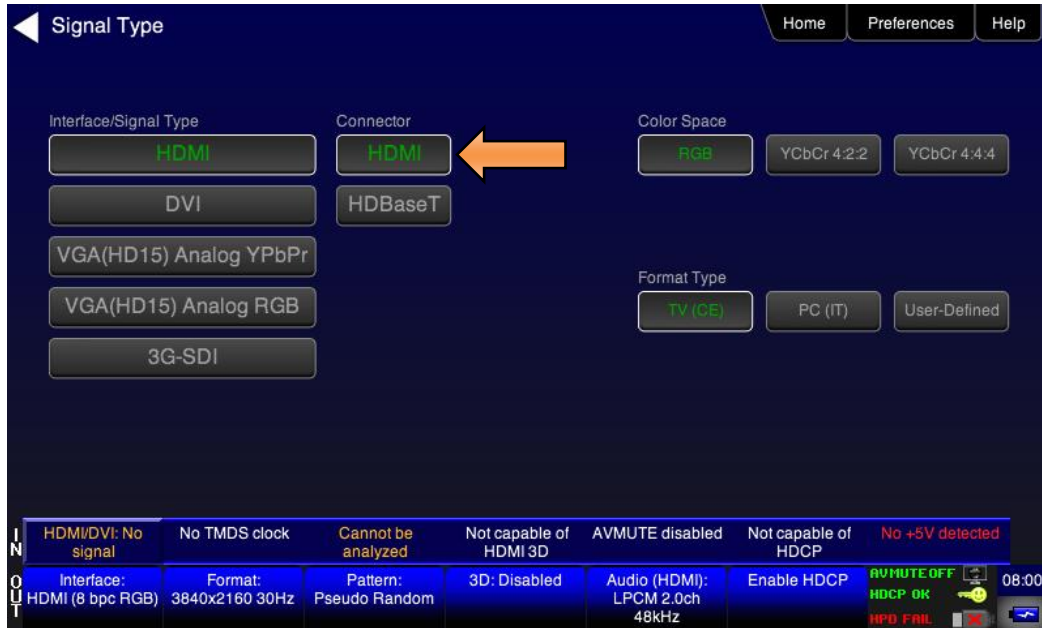
The 780C's HDBaseT input port acts as a "reference" HDBaseT source and sink device simultaneously. Therefore it enables you to emulate both a known good HDBaseT source and sink device to conduct diagnostics on a source devices upstream and sink devices downstream simultaneously. The following illustration shows the typical configuration.



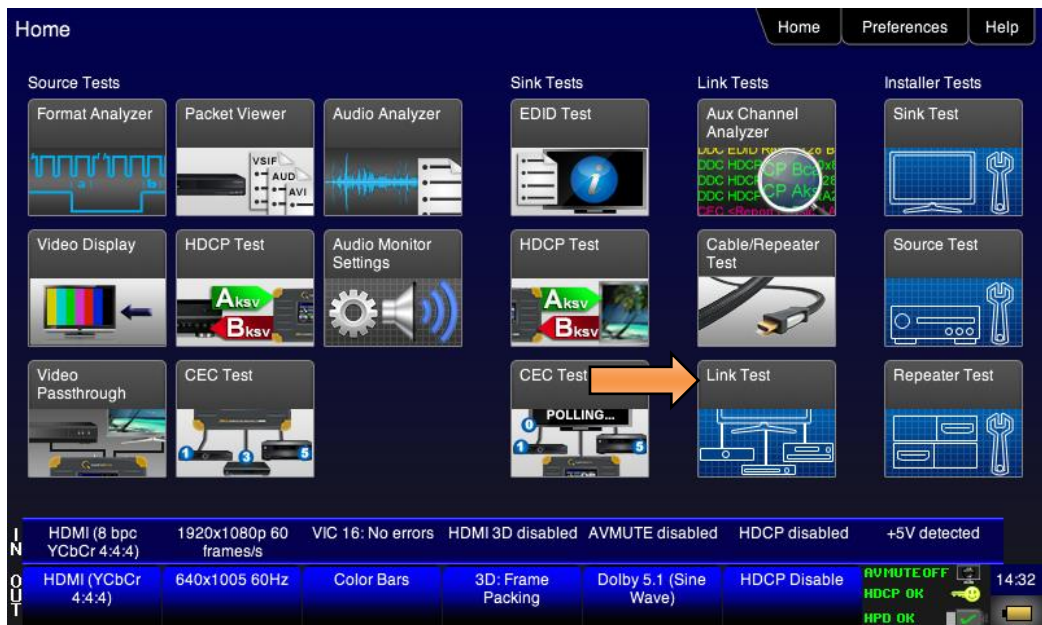
7.4.3 Procedures for Testing HDMI Networks (Links) with the Installer Utility

Use the following procedures to test the video on an HDMI link with the Installer Utility.

1. Make the physical connection between the 780C HDMI IN and OUT ports and the HDMI source and sink devices under test using the configuration instructions above or by following the instructions on the screen.
2. Enable the HDMI as the active digital interface input as shown below.

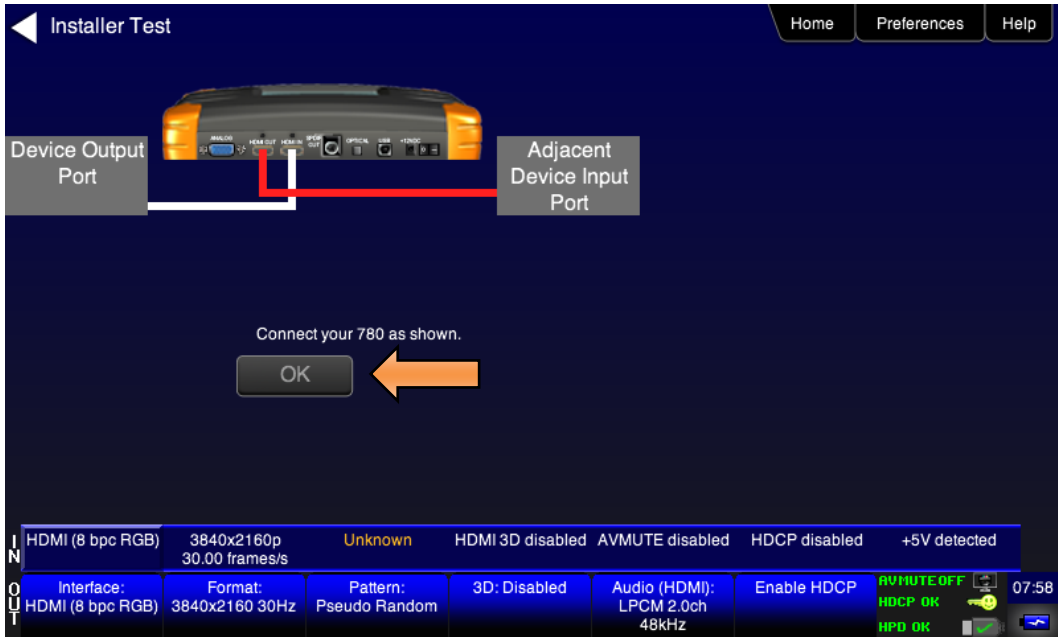


3. Touch select **Link Test** from **Installer Tests** from the **Home** menu shown below.

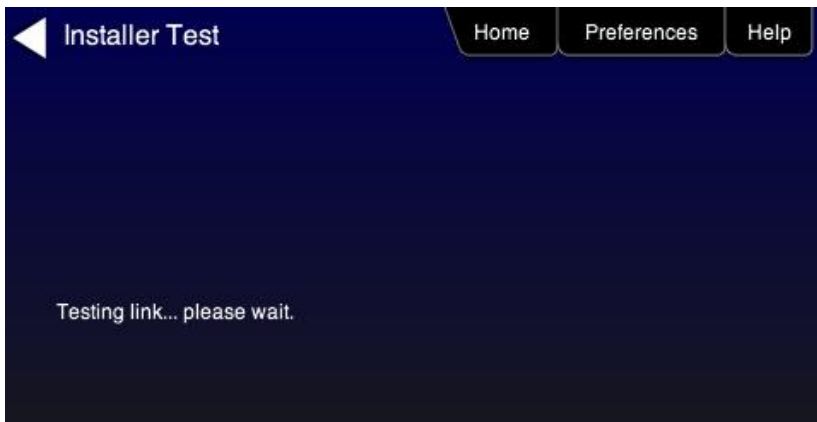


A diagram will appear on the 780C display depicting the proper setup for the Link Test.

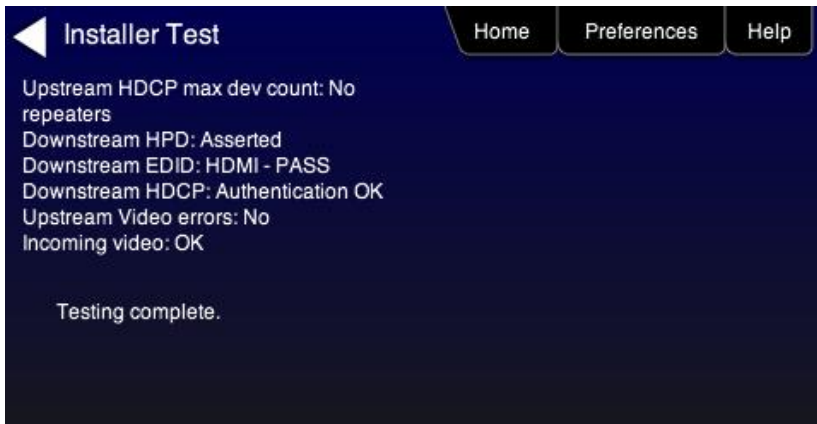
4. Touch select the **OK** activation button to initiate the test.



The test will run for up to about a minute. A status screen is provided as shown below.



You will be instructed to switch interfaces on the HDTV during the test. Touch select the appropriate the **OK** activation button.



8 Using the 780C to Monitor the HDMI/HDBaseT CEC and DDC channel

This section provides procedures for using the *optional* Auxiliary Channel Analyzer (ACA) feature. This option enables you to monitor the following:

- HDMI/HDBaseT DDC and CEC emulation monitoring with Auxiliary Channel Analyzer (ACA) – The 780C ACA enables you to monitor DDC transactions such as HDCP and EDID as well as hot plug related events while emulating an HDMI/HDBaseT source and/or sink device(s) in an HDMI/HDBaseT system.
- DDC and CEC passive monitoring with Auxiliary Channel Analyzer (ACA) – The 780C ACA enables you to passively monitor HDMI CEC and DDC transactions between an HDMI source and sink. You can monitor +5V, hot plug events as well as the HDCP and EDID transactions and CEC messages.

These ACA features require a license key and can be enabled remotely. **The features and functions described in this section are included only if you have purchased the Auxiliary Channel Analyzer option.**

8.1 Auxiliary Channel Analyzer (ACA) Transactions

This subsection describes the ACA transaction screens. The screen shot and tables below describes the Auxiliary Channel Analyzer control buttons and on-screen transactions.



Note: You can scroll through the transactions up or down (older to more recent) by sliding your finger or stylus up or down on the touch screen.

The following table describes the control buttons on the top of the ACA screen.

Table 8-2: Auxiliary Channel Analyzer activation button description	
Button	Description
Start/Stop	A toggle button to initiate and then halt the collection of ACA transactions. You must stop the collection if you want to save the transactions or view the details. Once stopped you can scroll through the transactions by moving your finger or stylus up or down.

Table 8-2: Auxiliary Channel Analyzer activation button description	
Button	Description
Save	Enables you to name and save an ACA trace for later examination and exporting to other colleagues. Once exported the saved traces can be viewed either through another 780 or through the ACA viewer application available from the Quantum Data website.
Clear	Clears out the trace transactions shown on the 780 display.
Details	Enables you to view the details of the transaction that is highlighted. Also enable you to return to the main screen with the transactions.
Auto Scroll	Automatically moves the viewer to the most recently collected transactions.

Table 8-2: Auxiliary Channel Analyzer record description		
Data type	Description	Color coding
Hot Plug indication	An indication from the HDMI/HDBaseT sink to the HDMI/HDBaseT source that there is a device connected. The Hot Plug voltage is a steady. In the case of a repeater, it is a 100ms pulse.	Blue
+5V	A voltage from an HDMI/HDBaseT source to the HDMI/HDBaseT sink to power the hot plug voltage. The +5V is a steady voltage nominally 5 volts.	Cyan
EDID Exchange	A data set in the HDMI/HDBaseT sink that describes its capabilities to a connected source device. This data is transmitted over the DDC channel.	Yellow
HDCP Transactions	Content protection authentication and encryption transactions. The source initiates HDCP for protected content. Various values and registers are exchanged over the DDC.	Green
CEC messages	CEC messages are transmitted over a one wire CEC bus. These messages are monitored through the ACA	Magenta
Errors	The DDC channel uses the I2C protocol. Errors in the I2C protocol are shown in the ACA transactions.	Red
Notes: <ol style="list-style-type: none"> 1. For each transaction there is a timestamp. The timestamps are: HH:MM:SS:MSEC format. They are best used for comparing between transactions. 2. Each transaction has a type indicate which can be: DDC, Hot Plug, CEC or 5V. 3. Each transaction there is a directional indicator, U – Upstream, D – Downstream. This pertains to the location of the 780 relative to the network it is exchanging information with. Upstream means that the 780 is upstream and communicating downstream and Downstream means that the 780 is downstream and communicating upstream. 		

You can save these transactions and then view them on the Quantum Data external ACA viewer which is available for free on the Quantum Data website.

8.2 Auxiliary Channel Analyzer – Emulation Monitoring of DDC on Sink

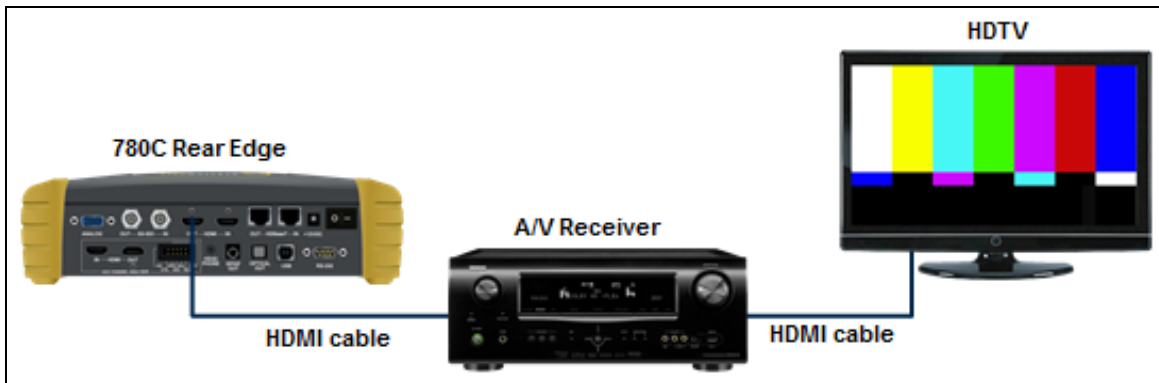
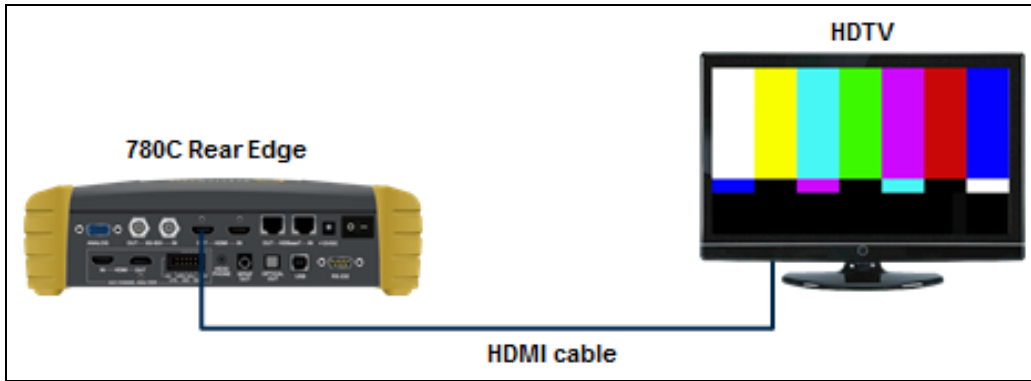
The Aux Channel Analyzer test monitors the DDC channel transactions and hot plug events while emulating HDMI devices. **The features and functions described in this section are included only if you have purchased the Auxiliary Channel Analyzer option.**

You can view the details of each transaction and save the traces for viewing on the external ACA application available from the Quantum Data website.

8.2.1 Configurations for Monitoring DDC Transactions with ACA on HDMI Sink Devices

This subsection provides configuration diagrams that depict ACA monitoring of HDMI sink devices, with or without a repeater while the 780C is emulating an HDMI source device.

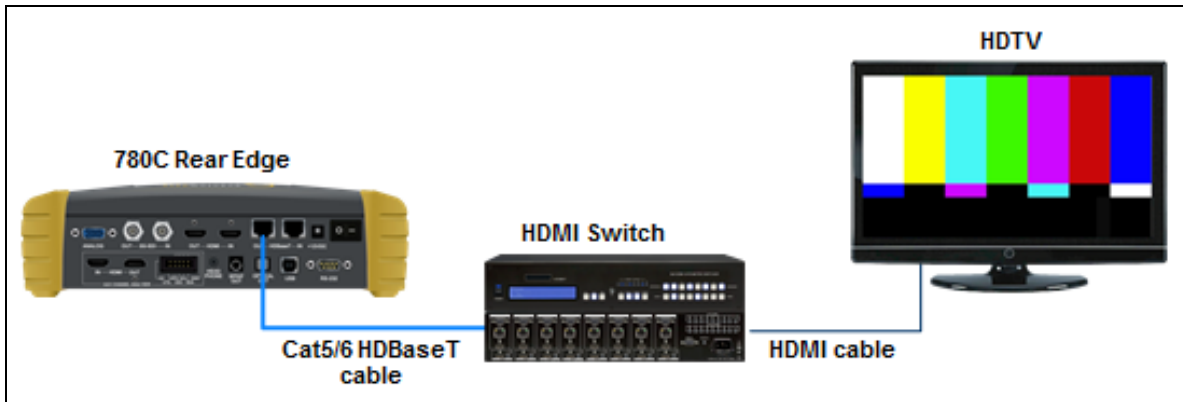
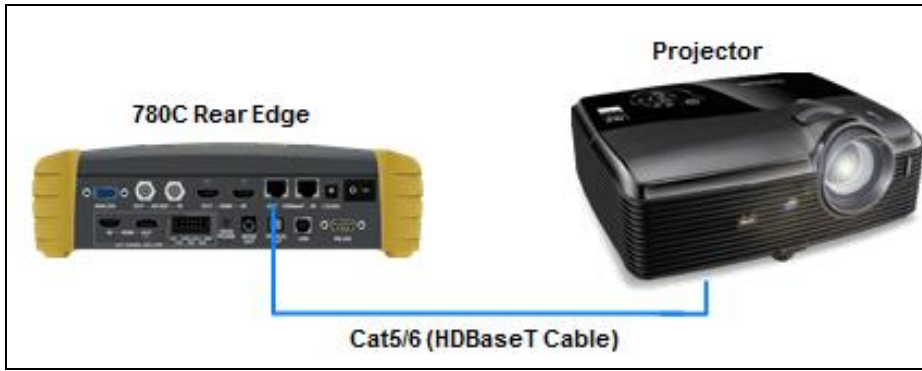
1. Connect the HDMI or HDBaseT sink devices to the 780C in either of the ways shown in the diagrams below and described as follows:
 - a. The HDMI sink device input is connected the 780C HDMI OUT connector.OR
 - b. The HDMI repeater device input is connected to the 780C HDMI OUT connector.



8.2.2 Configurations for Monitoring DDC Transactions with ACA on HDBaseT Sink Devices

This subsection provides configuration diagrams that depict ACA monitoring on HDBaseT sink devices, with or without a repeater while the 780C is emulating an HDBaseT source device.

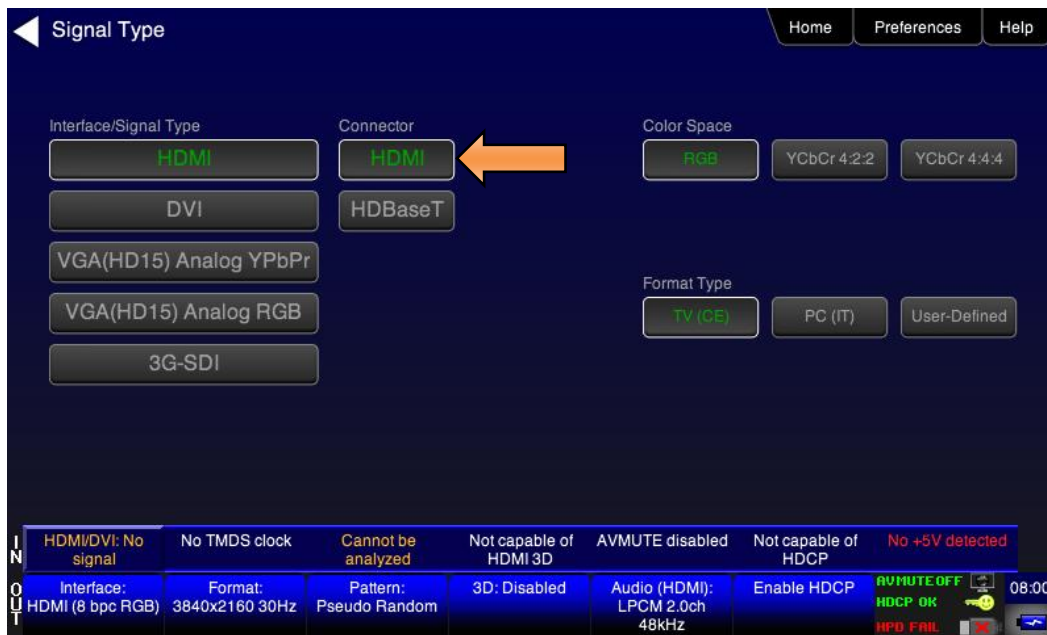
1. Connect the HDBaseT system devices to the 780C in either of the ways shown in the diagrams above and described as follows:
 - a. The HDBaseT sink device input is connected the 780C HDBaseT OUT connector.OR
 - b. The HDBaseT repeater device input is connected to the 780C HDBaseT OUT connector.



8.2.3 Monitoring DDC Transactions with ACA on HDMI or HDBaseT Sink Devices

This subsection provides configuration diagrams that depict ACA monitoring of HDMI or HDBaseT sink devices, with or without a repeater while the 780C is emulating an HDMI or HDBaseT source device.

1. Enable the HDMI or HDBaseT as the active digital interface input as shown below.



2. From the **Home** screen (shown below) touch select the **Aux Channel Analyzer** activation button.



The **ACA Setup Options** screen appears:



- 5. Select the data types that you wish to monitor. In this application you would select data types from the **Tx Port side**.
- 6. Determine what data types you wish to monitor. Typically you will want to monitor the DDC and hot plug (+5V only available with passive monitoring option).

Note: By default the two activation buttons labeled **780C Tx Port** and **780C Rx port** are enabled. You cannot disable them. Transactions will be shown based on which ports (HDMI/HDBaseT OUT and/or

HDMI/HDBaseT IN) are connected to HDMI/HDBaseT devices and which set of transactions you have enabled (i.e. DDC, HPD on Tx or Rx side).



7. Enable HDCP on the 780C **HDMI or HDBaseT OUT** port. Use the procedures in the section entitled: [Testing HDCP on an HDMI HDTV or HDMI Repeater Device](#).
8. Take whatever action necessary to initiate a new HDCP authentication. Typically this would be a hot plug event at the sink device you are testing. Alternatively you can simply disable and re-enable HDCP on the 780C.
9. Touch select the **Capture Data Table** activation button to initiate the capturing of the data. A screen similar to the one shown below will appear.



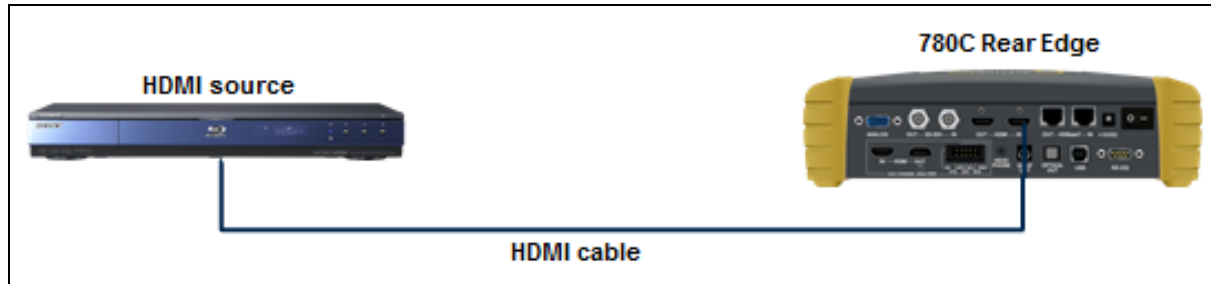
10. Touch select the **Details** activation button (top center) to view the details of any specific transaction that you have selected. The following screen is an example of the details screen for the BCAPS register.



11. Touch select **Stop** activation button (top left) to halt the collection of messages.
12. Touch select **Clear** activation button (top center) to clear the collected of messages.

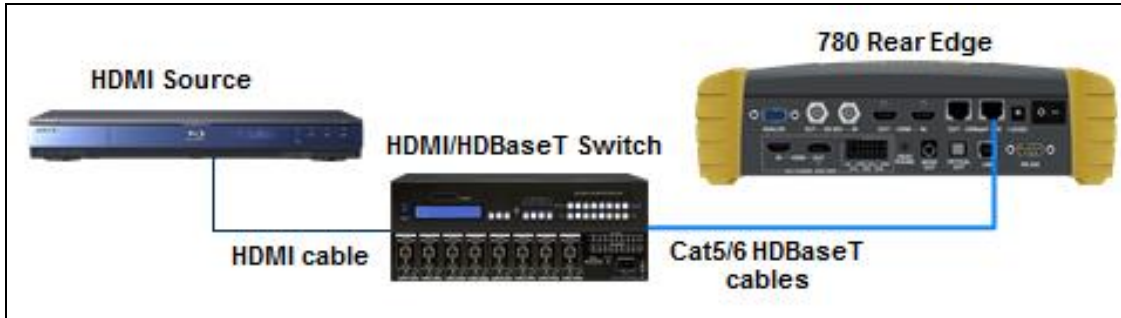
8.2.4 Configurations for Monitoring DDC Transactions with ACA on HDMI Source Devices

This subsection provides configuration diagrams that depict ACA monitoring of HDMI source devices, with or without a repeater, while the 780C is emulating an HDMI sink device.



8.2.5 Configurations for Monitoring DDC Transactions with ACA on HDBaseT Source Devices

This subsection provides configuration diagrams that depict ACA monitoring of HDBaseT source devices, with or without a repeater, while the 780C is emulating an HDBaseT sink device.

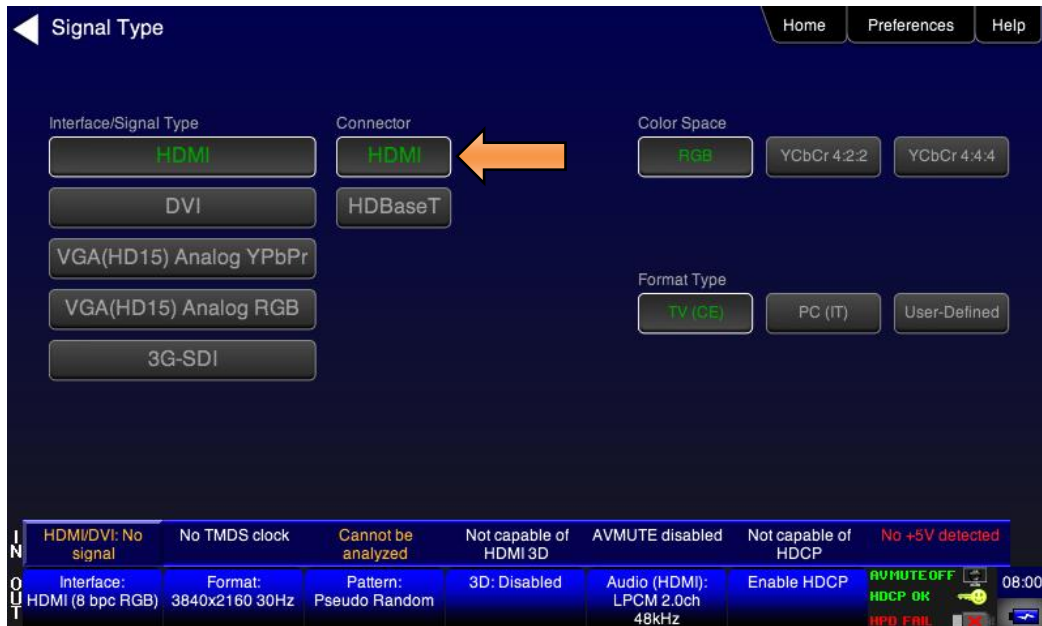


8.2.6 Procedures for Monitoring the DDC Transactions using the Auxiliary Channel Analyzer on HDMI or HDBaseT Source Devices

This subsection provides procedures for ACA monitoring of HDMI and HDBaseT source devices, with or without a repeater while the 780C is emulating an HDMI or HDBaseT sink device with HDCP capabilities.

Note: You will have to obtain a license key for the ACA option to use the feature.

1. Connect the HDMI or HDBaseT source devices to the 780C in either of the ways shown in the diagrams above and described as follows:
 - a. The HDMI source device output is connected the 780C HDMI IN connector.
 - OR
 - b. The HDMI/HDBaseT repeater device output is connected to the 780C HDMI/HDBaseT IN connector.
 - c. The HDMI source device output is connected to the HDMI/HDBaseT repeater device input.
2. Enable the HDMI or HDBaseT interface as the active digital interface input as shown below.



3. From the Home screen (shown below) touch select the Aux Channel Analyzer activation button.

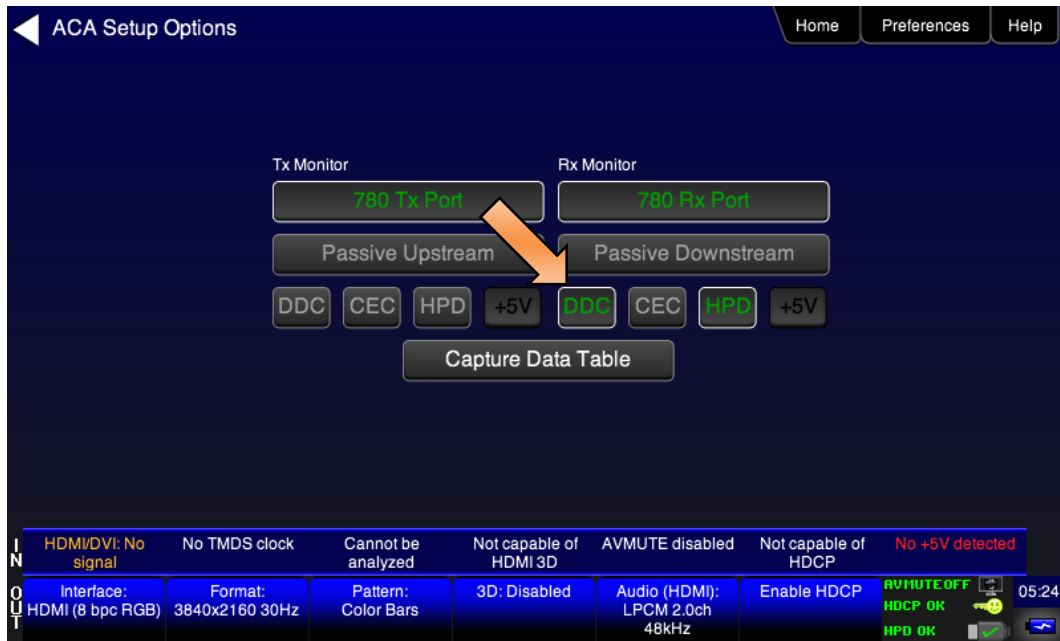


The **ACA Setup Options** screen appears:



4. Select the data types that you wish to monitor on the **Rx Port** side.
5. Determine what data types you wish to monitor. Typically you will want to monitor the DDC, hot plug (shown in the example above).

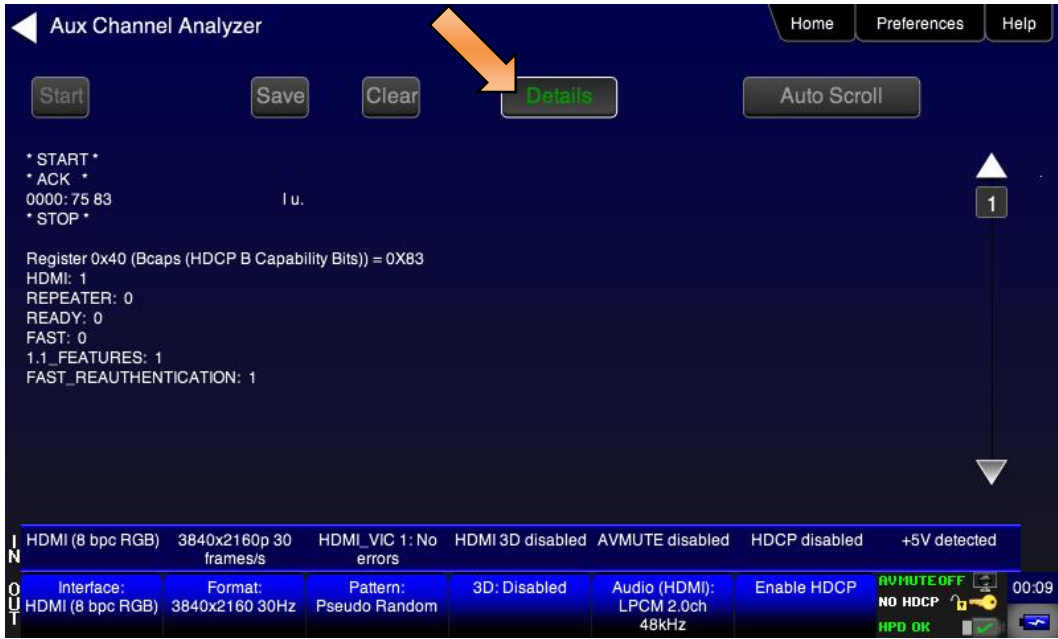
Note: By default the two activation buttons labeled **780C Tx Port** and **780C Rx port** are enabled. You cannot disable them. Transactions will be shown based on which ports (HDMI/HDBaseT OUT and/or HDMI/HDBaseT IN) are connected to HDMI/HDBaseT devices and which set of transactions you have enabled (i.e. DDC, HPD on Tx or Rx side).



6. Take whatever action necessary to initiate a new HDCP authentication. Typically this would be a hot plug event, for example a disconnection and reconnection on the 780C **HDMI/HDBaseT IN** port.
7. Touch select the **Capture Data Table** activation button to access the Auxiliary Channel Analyzer screen. Then touch select **Start** to initiate the capturing of the data. A screen similar to the one shown below will appear.



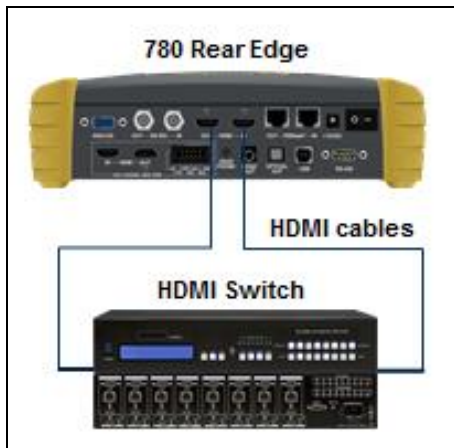
8. Touch select the **Details** activation button (top center) to view the details of any specific transaction that you have selected. The following screen is an example of the details screen. The screen below shows a detailed view of the BCAPS register.

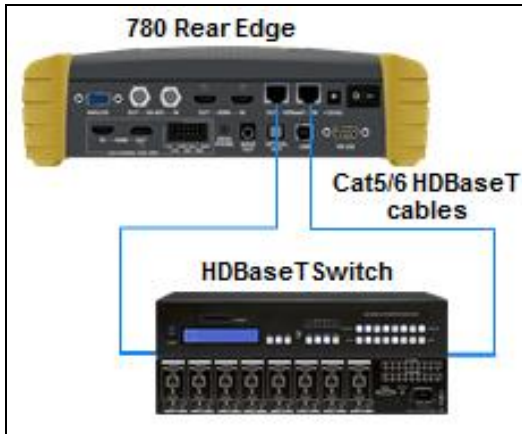


9. Touch select **Stop** activation button (top left) to halt the collection of messages.
10. Touch select **Clear** activation button (top center) to clear the collected of messages.

8.3 Configuration for Monitoring DDC Transactions with the ACA on an HDMI or HDBaseT Repeater or distribution device

This subsection provide a configuration diagram that depicts ACA monitoring of HDMI/HDBaseT repeater devices while emulating both an HDMI/HDBaseT source device and an HDMI/HDBaseT sink device.

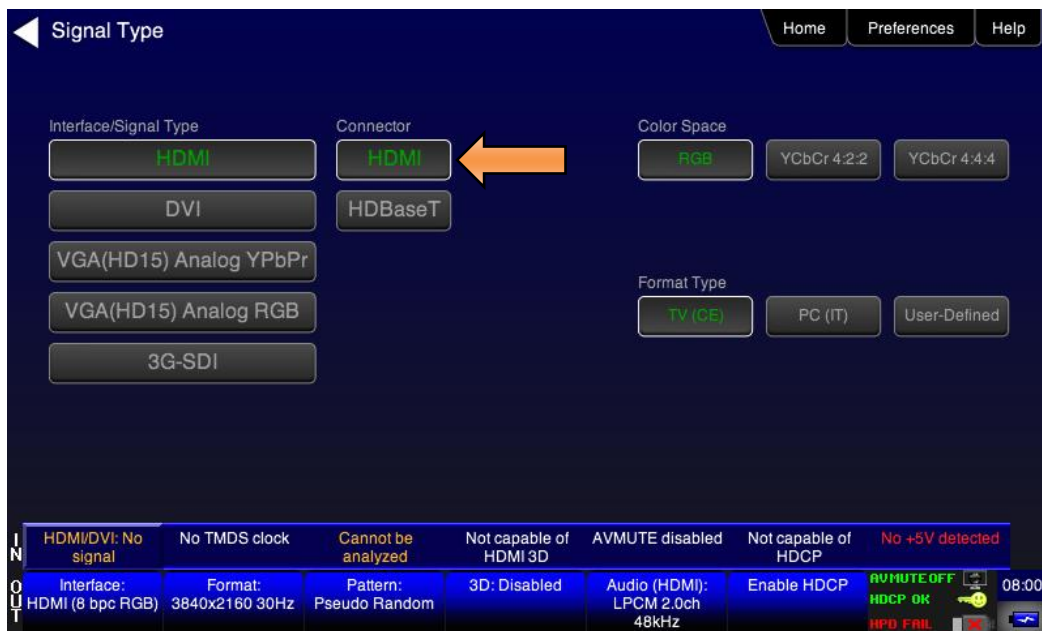




8.3.1 Procedures for Running an Auxiliary Channel Analyzer Test on HDMI/HDBaseT Repeater or Distribution Devices

This subsection provides procedures for ACA monitoring of HDMI/HDBaseT repeater devices while the 780C is emulating both an HDMI/HDBaseT sink device and an HDMI/HDBaseT source device.

1. Connect the HDMI system devices to the 780C as shown in the diagrams above and described as follows:
 - a. The HDMI/HDBaseT repeater device input is connected the 780C **HDMI/HDBaseT OUT** connector.
 - b. The HDMI/HDBaseT repeater device output is connected to the 780C **HDMI/HDBaseT IN** connector.
2. Enable the HDMI or HDBaseT interface as the active digital interface input as shown below.



3. From the Home screen (shown below) touch select the Aux Channel Analyzer activation button.

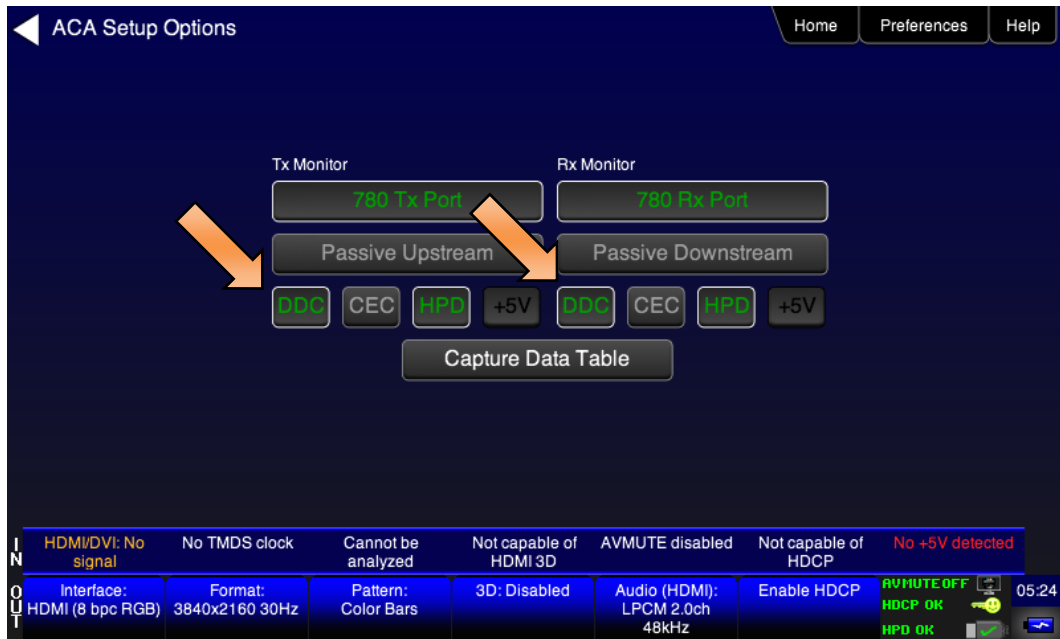


The **ACA Setup Options** screen appears:



- Determine what data types you wish to monitor. Typically you will want to monitor the DDC and hot plug (+5V is only available for monitoring with the passive monitoring option). Select the data types that you wish to monitor.

Note: By default the two activation buttons labeled **780C Tx Port** and **780C Rx Port** are enabled. You cannot disable them. Transactions will be shown based on which ports (**HDMI OUT** and/or **HDMI IN**) are connected to HDMI devices and which transaction types (i.e. DDC and HPD) you have enabled.



5. Enable HDCP on the 780C **HDMI OUT** port. Use the procedures in the section entitled: [Configurations for Testing HDCP on an HDMI Sink Device](#).
6. Take whatever action necessary to initiate a new HDCP authentication. Typically this would be a hot plug event at the sink device you are testing. Alternatively you can simply disable and re-enable HDCP on the 780C.
7. Touch select the **Capture Data Table** activation button to initiate the capturing of the data. A screen similar to the one shown below will appear.



Note: There are both upstream and downstream transactions mixed in the screen example above.

8. Touch select the **Details** activation button (top center) to view the details of any specific transaction that you have touch selected. The following screen is an example of the details screen. A detailed view of the BCAPS register is shown. Touch Details again to return to the ACA transaction screen.



9. Touch select **Stop** activation button (top left) to halt the collection of messages.
10. Touch select **Clear** activation button (top center) to clear the collected of messages.

8.4 Auxiliary Channel Analyzer – Passive Monitoring

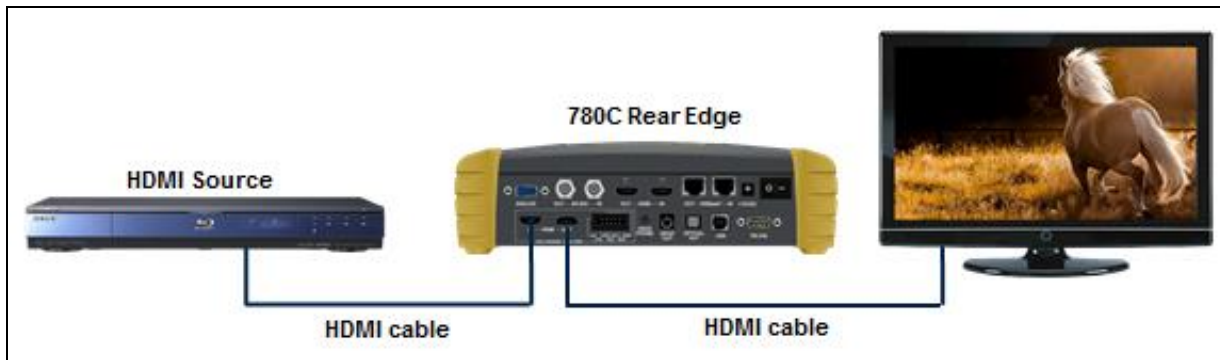
The Aux Channel Analyzer test monitors the CEC and DDC channel transactions and hot plug events. You can monitor the events while emulating either an HDMI source or sink device or you can passively monitor the transactions. This subsection provides procedures on passive monitoring. ***The features and functions described in this section are included only if you have purchased the Auxiliary Channel Analyzer – Passive Monitoring option.***

You can view the details of each transaction and save the traces for viewing on the external ACA application available from the Quantum Data website.

8.4.1 Configurations for Passively Monitoring CEC and or DDC Transactions with ACA on an HDMI System

This subsection provides configuration diagrams that depict ACA passive monitoring of an HDMI system.

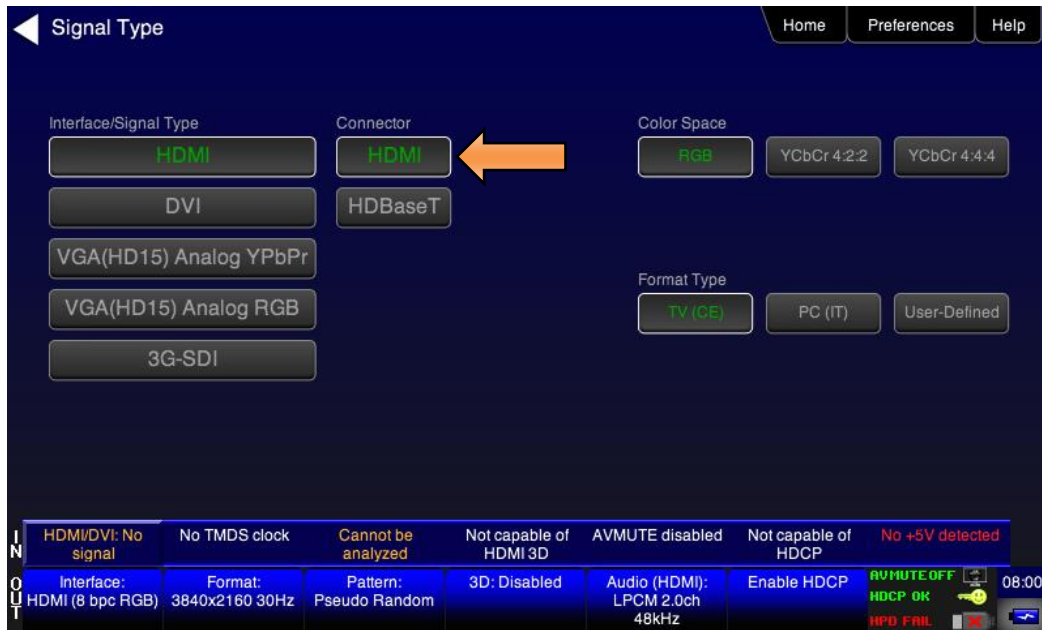
1. Connect the HDMI system devices to the 780C as shown in the diagram below and described as follows:
 - a. The HDMI source is connected to the 780C **ACA IN** connector.
 - b. The HDMI sink device (e.g. HDTV) is connected to the 780C **ACA OUT** connector.



8.4.2 Procedures for Passive Monitoring DDC transactions and hot plug events with the Auxiliary Channel Analyzer on HDMI Devices

This subsection provides procedures for ACA passive monitoring of HDMI devices.

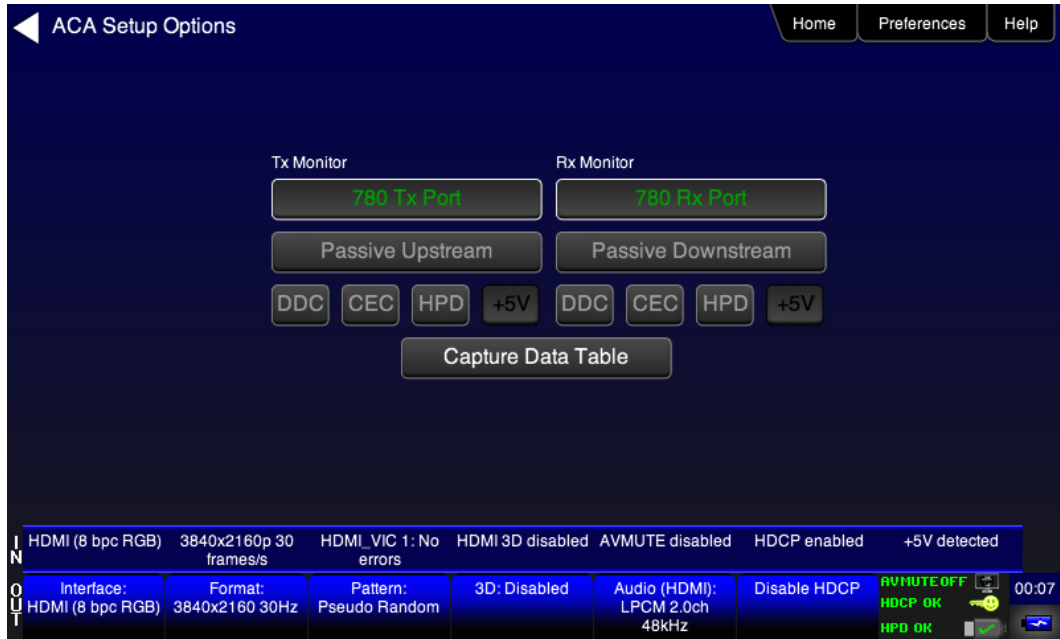
1. Enable the HDMI interface as the active digital interface input as shown below.



2. From the **Home** screen (shown below) touch select the **Aux Channel Analyzer** activation button.



The **ACA Setup Options** screen appears:



3. Select the data types that you wish to monitor. In this application you would select either **Passive Upstream** or **Passive Downstream**.
4. Determine what data types you wish to monitor. Typically you will want to monitor the DDC and hot plug and +5V. Refer to the screen example below.



5. Enable HDCP on the HDMI source device under test. Use the procedures in the section entitled: [Testing HDCP on an HDMI HDTV or HDMI Repeater Device](#).
6. Take whatever action necessary to initiate a new HDCP authentication. Typically this would be a hot plug event at the sink device you are testing.
7. Touch select the **Capture Data Table** activation button to initiate the capturing of the data. A screen similar to the one shown below will appear.



- Touch select the **Details** activation button (top center) to view the details of any specific transaction that you have selected. The following screen is an example of the details screen. This example shows the BCAPS register details. Touch select the **Details** activation button again to return to the trace view.



- Touch select **Stop** activation button (top left) to halt the collection of messages.
- Touch select **Clear** activation button (top center) to clear the collected of messages.

8.5 Auxiliary Channel Analyzer – Monitoring of CEC Messages

The Aux Channel Analyzer test monitors the CEC channel message while emulating HDMI/HDBaseT devices. **The features and functions described in this section are included only if you have purchased the Auxiliary Channel Analyzer option.**

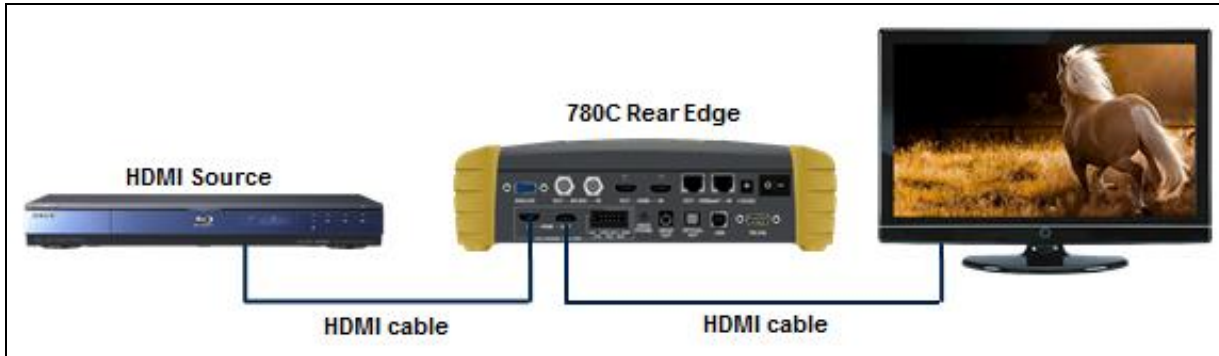
You can view the details of each transaction and save the traces for viewing on the external ACA application available from the Quantum Data website.

8.5.1 Procedures for Passive Monitoring HDMI CEC messages with the Auxiliary Channel Analyzer

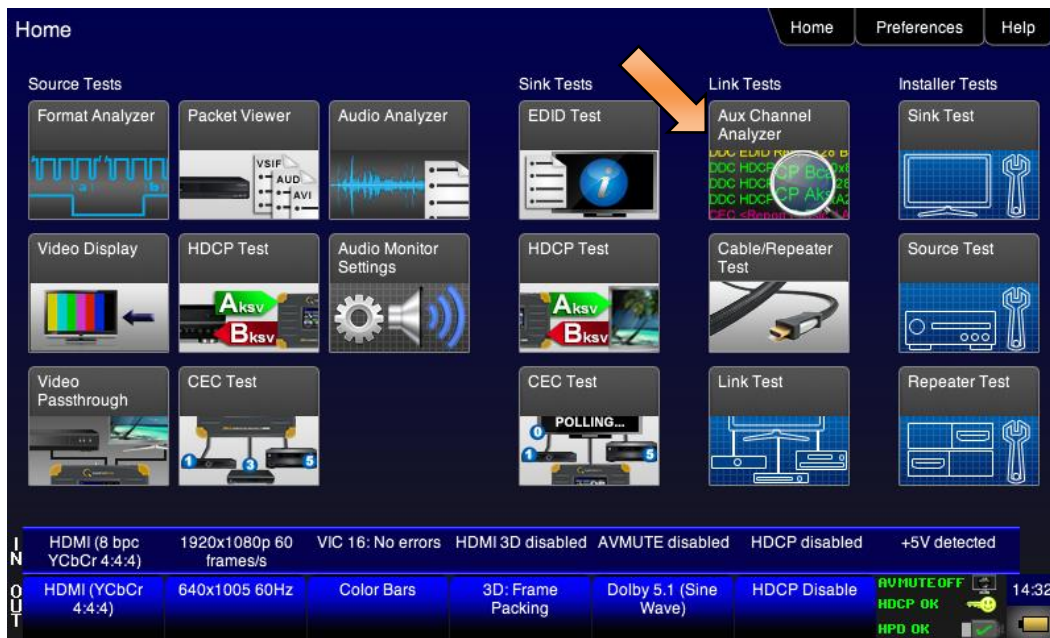
This subsection provides procedures for ACA passive monitoring of CEC messages on HDMI devices.

Note: You will have to obtain a license key for the ACA passive monitoring option to use the feature.

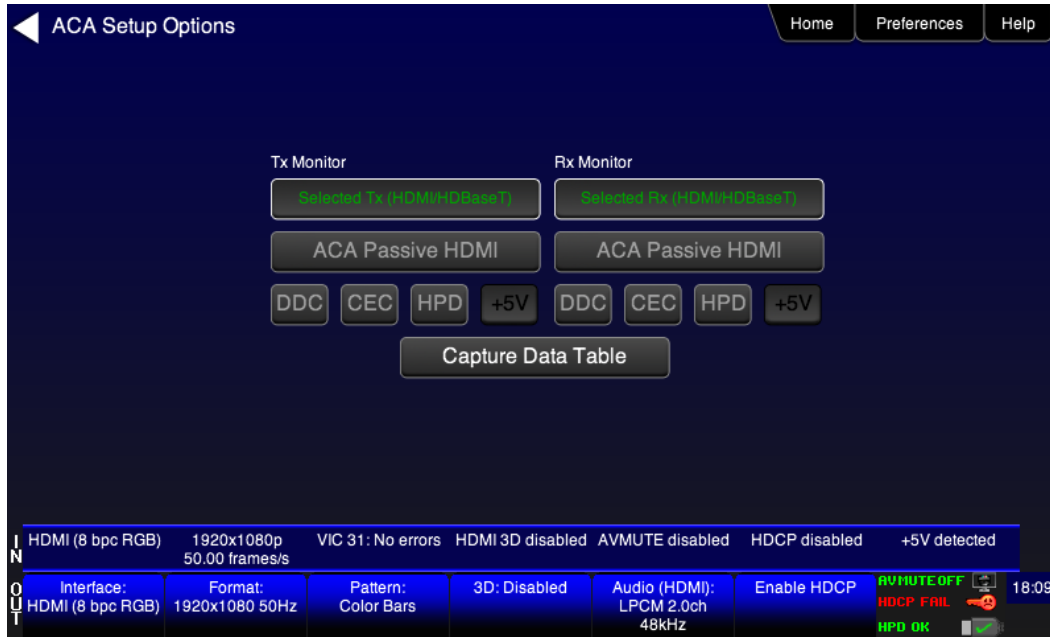
1. Connect the HDMI system devices to the 780C as shown in the diagram above and described as follows:
 - a. The HDMI source is connected to the 780C **ACA IN** connector.
 - b. The HDMI sink device (e.g. HDTV) is connected to the 780C **ACA OUT** connector.



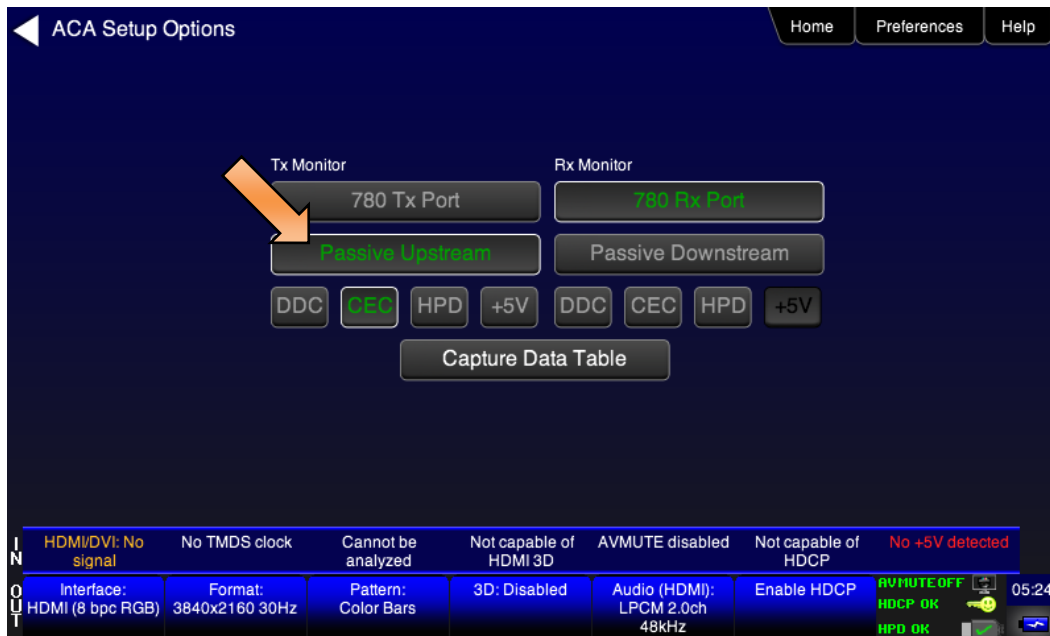
2. From the **Home** screen (shown below) touch select the **Aux Channel Analyzer** activation button.



The **ACA Setup Options** screen appears:



3. Select the CEC to monitor. In this application you would select **Passive Upstream**. Note that you need only set either the **Passive Upstream** or **Passive Downstream**.



4. Enable HDCP on the HDMI source device under test. Use the procedures in the section entitled: [Testing HDCP on an HDMI HDTV or HDMI Repeater Device](#).
5. Take whatever action necessary to initiate CEC messages.
6. Touch select the **Capture Data Table** activation button to initiate the capturing of the data. A screen similar to the one shown below will appear.



Touch select the **Details** activation button (top center) to view the details of any specific transaction that you have selected. The following screen is an example of the details screen. These screen examples show polling example.



7. Touch select **Stop** activation button (top left) to halt the collection of messages.
8. Touch select **Clear** activation button (top center) to clear the collected of messages.

9 Using the 780C Test Instrument to Test HDMI Cable or Repeaters

This section provides procedures for testing HDMI cables, cable extenders, splitters, repeaters, etc. The HDMI/DVI Cable Test runs a pixel error test on the TMDS leads and a continuity check on the 5V & hot plug leads and the DDC leads. The Repeater test runs a pixel error test on the TMDS leads and a continuity check on the 5V & hot plug leads and the DDC leads but additionally tests the hot plug delay and the hot plug width.

The cable test and repeater test can be used when the source and sink ends are collocated, in other words can be connected to the 780C Tx and Rx ports. For a cable or distribution system that is installed and where the source and sink ends cannot be connected to the 780C, you can use the Frame Compare feature. The Frame Compare feature captures a reference frame and then compares a series of captured frames pixel by pixel to the reference frame.

The features and functions described in this section are included only if you have purchased the HDMI Cable and Link Test option.

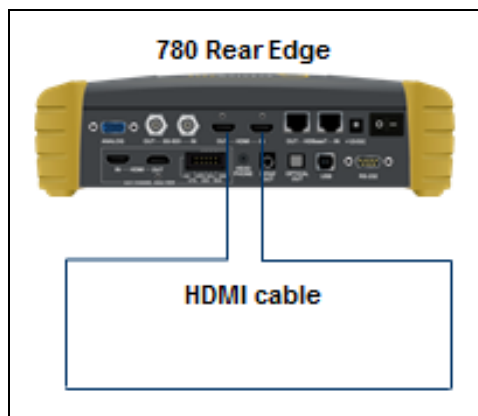
9.1 HDMI/HDBaseT Cable or Repeater Test

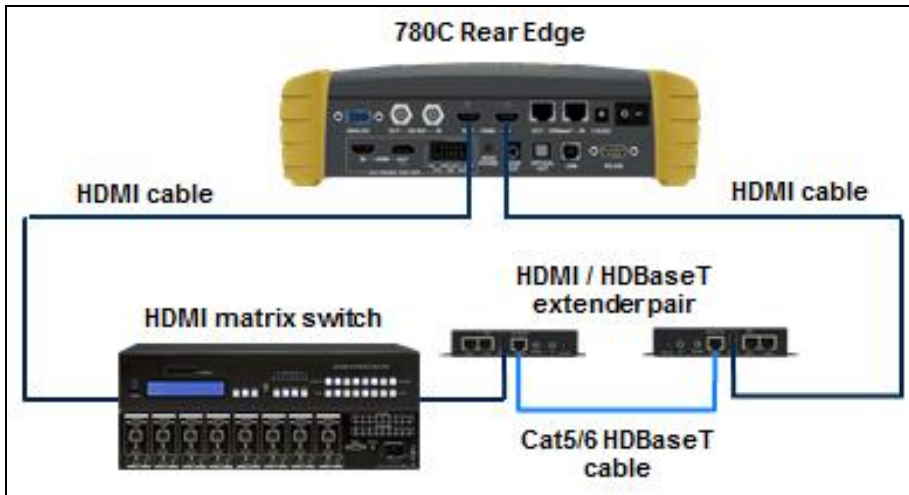
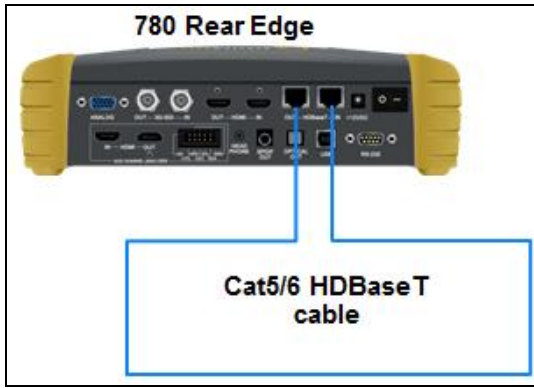
The HDMI/DVI/HDBaseT Cable Test runs a test on all the leads in the HDMI/HDBaseT (CAT) cable and HDMI or HDBaseT networks (when extenders, splitters, switchers and repeaters are used) except the power bus as follows:

- Pixel error test using a pseudo-noise pattern on the TMDS lines using three separate timings:
 - 480p60 using 8 bit/component color
 - 720p60 using 8 bit/component color
 - 1080p60 using 8 bit/component color
 - 1080p60 using 12 bit/component (deep color)
 - 2160p30 using 8 bit/component color
- Read/write test on the DDC leads and the CEC bus. It reads an EDID at the output from the input.
- Continuity test on the 5V/Hot plug leads.
- Hot plug delay and hot plug pulse width. The hot plug delay is the time that elapses between the falling edge of the hot plug line on the on the sink side of a repeater and the falling edge of the hot plug line on the source side. The hot plug pulse width is the time that the hot plug pulse goes low as detected on the HDMI Tx side.

9.1.1 Configurations for Running an HDMI/HDBaseT Cable or Repeater Test

This subsection provides configurations supported when performing an HDMI/HDBaseT cable test or a test of an HDMI network comprised of repeaters, splitters, extenders, switches, etc.





9.1.2 Procedures for Running an HDMI/HDBaseT Cable or Network (“Repeater”) Test

This subsection provides procedures for performing an HDMI cable test or a test of an HDMI network comprised of repeaters, splitters, extenders, switches, etc.

1. For testing an HDMI cable, connect one end of the HDMI cable to the 780C **HDMI OUT** connect and the other end to the 780C **HDMI IN** connector.

For testing an HDBaseT cable, connect one end of the HDBaseT CAT cable to the 780C **HDBaseT OUT** connect and the other end to the 780C **HDBaseT IN** connector.

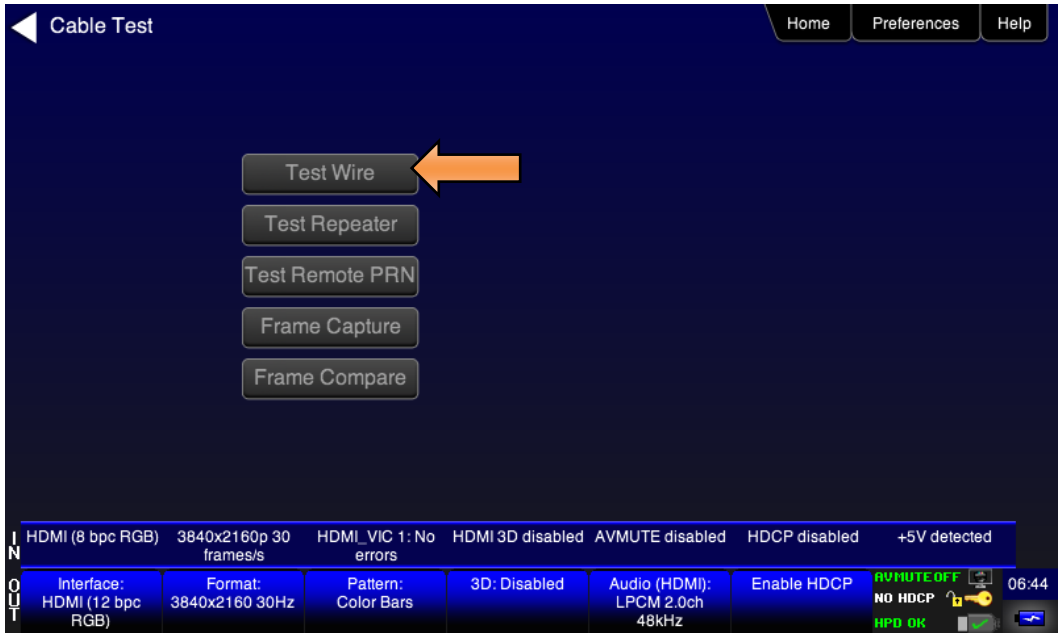
For testing an HDMI repeater device such as a repeater, video or audio processor, extender, switch, etc, connect the 780C **HDMI OUT** connector to the repeater device input and connect the 780C **HDMI IN** connector to the repeater device output.

2. Touch select **Cable/Repeater Test** from the **Home** menu shown below.

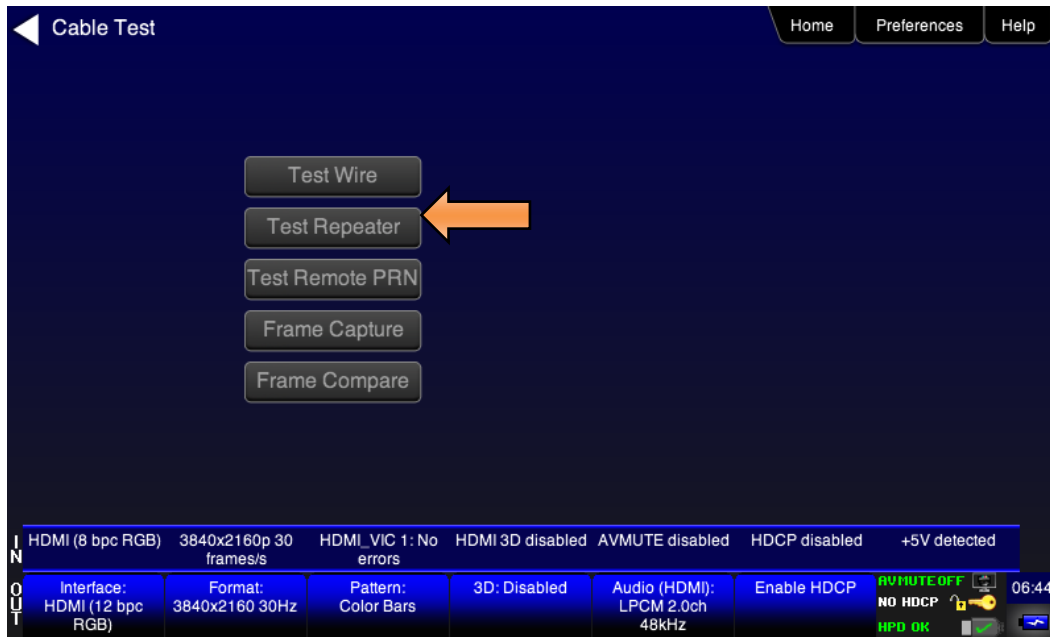


3. For testing an HDMI cable touch select **Test Wire** to initiate the test.

The pixel errors are displayed for each timing on the screen as shown below. The +5V, Hot Plug and DDC test results are shown as Pass/Fail.



For testing an HDMI repeater device touch select **Test Repeater** to initiate the test.



When a repeater device is tested using the **Test Repeater** function, the hot plug pulse delay and the hot plug pulse width are shown in addition to the information and results displayed for the Cable Test. In the Test Repeater function, the 780C initiates a hot plug event on its sink (HDMI IN) port. The hot plug delay is the time that elapses between the falling edge of the hot plug line on the sink side of a repeater and the falling edge of the hot plug line on the source side. The hot plug pulse width is the time that the hot plug pulse goes low as detected on the HDMI OUT side.



The following is an example of test on an HDBaseT CAT cable.

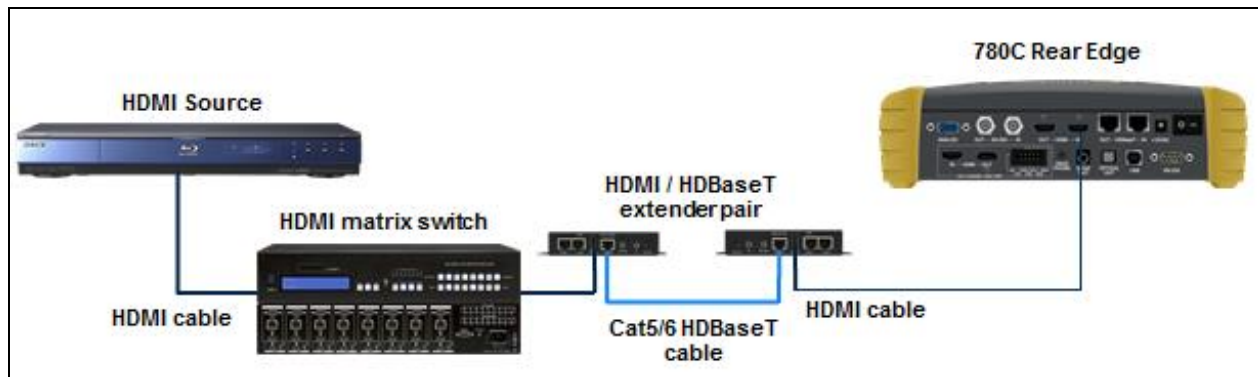


9.2 HDMI Frame Compare Test

The cable test and repeater test can be used when the source and sink ends are collocated, in other words can be connected to the 780C Tx and Rx ports. For a cable or distribution system that is installed and where the source and sink ends cannot be connected to the 780C, you can use the Frame Compare feature. The Frame Compare feature captures a reference frame and then compares a series of captured frames pixel by pixel to the reference frame.

9.2.1 Configuration for Running an HDMI Frame Compare Test

This subsection shows a typical configuration when performing an HDMI Frame Compare test for an HDMI cable or network comprised of repeaters, splitters, extenders, switches, etc.



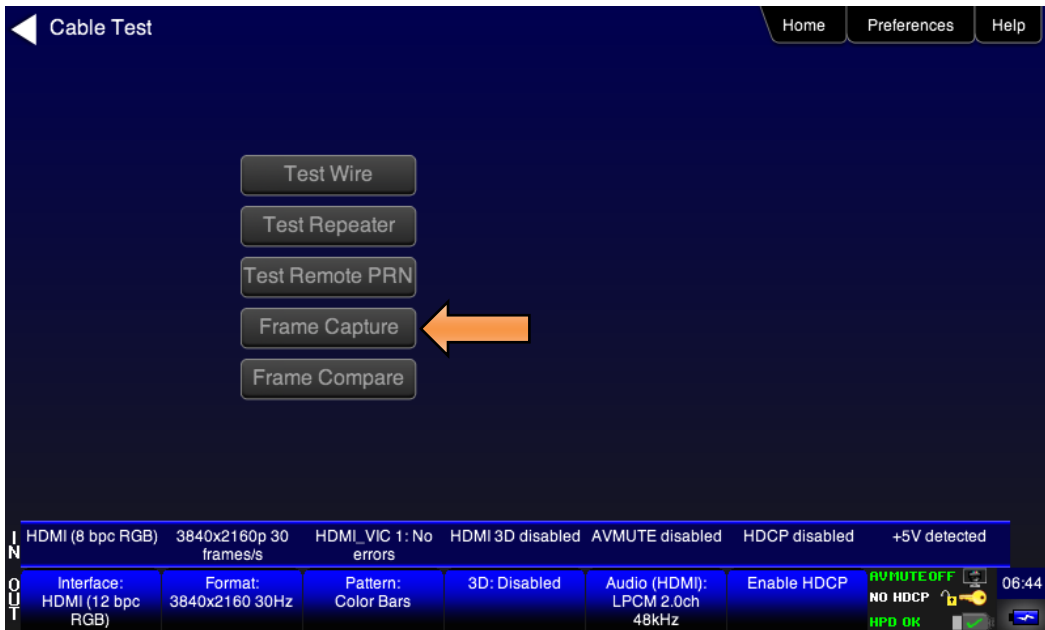
9.2.2 Procedures for Running the Frame Compare Test

This subsection provides procedures for performing an HDMI Frame Compare test on an HDMI network comprised of repeaters, splitters, extenders, switches, etc.

1. Connect the far end of the HDMI cable (at the display or HDTV) to the 780C HDMI IN connect as shown in the diagram above.
2. Touch select **Cable/Repeater Test** from the **Home** menu shown below.

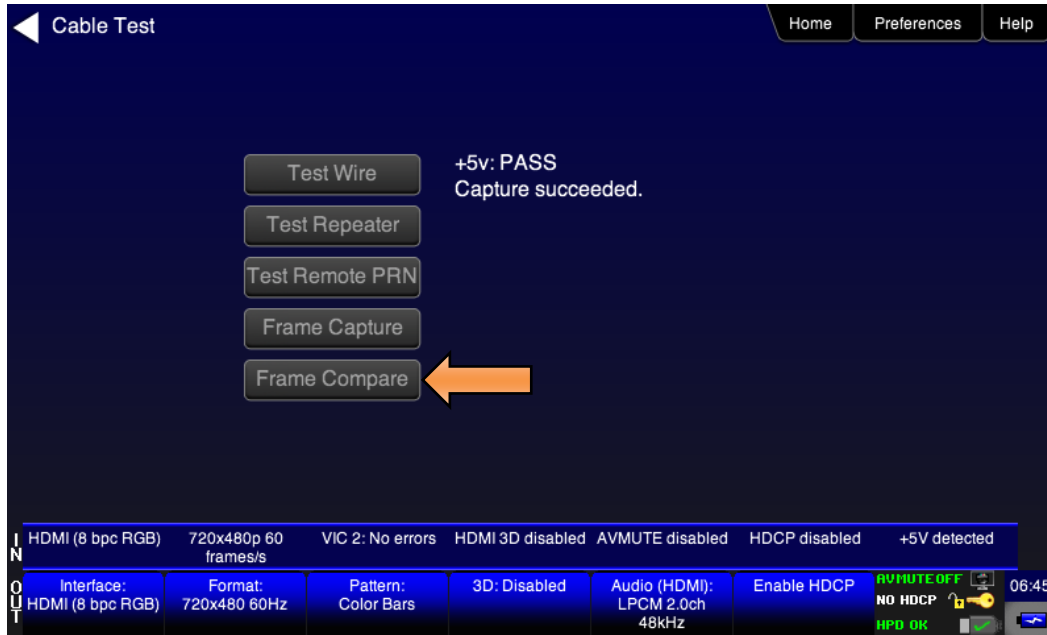


The following screen appears:



3. Select **Frame Capture** to capture a reference frame.

The 780C will capture a frame and indicate that the +5V was detected properly or not. The screen below shows these results.



4. Select **Frame Compare** to compare a series of frames to the reference frame.

The following screen example shows the results of the **Frame Compare** test. Note that the incoming resolution is shown with the number of pixel errors detected.



9.2.3 Procedures for Running the Remote PRN Test

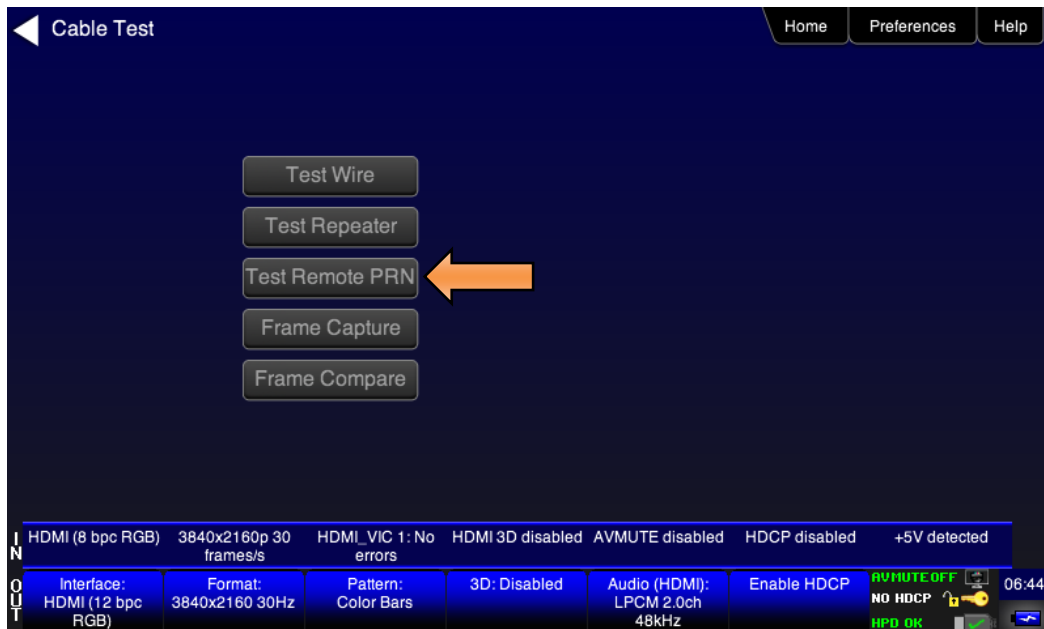
This subsection provides procedures for performing an HDMI Remote PRN test on an HDMI network comprised of repeaters, splitters, extenders, switches, etc. This test differs in that there is a 780 at both ends of the network—source and sink ends.

1. Follow the procedures above for rendering a Test Pattern on an HDMI HDTV Rendering Test Patterns on an HDMI HDTV.

2. Disconnect the source device at the near end of an HDMI distribution network and connect the HDMI cable to the first 780's HDMI output connector.
3. Disconnect the sink device at the far end of an HDMI distribution network and connect the HDMI cable to the second 780's HDMI input connector.
4. Touch select **Cable/Repeater Test** from the **Home** menu shown below.



The following screen appears:



5. Select **Test Remote PRN** to capture a reference frame.

The 780C will run the PRN test at the format resolution set for the 780 at the source end. Repeat the test at other resolutions and bit depths.



10 Running the Automated EDID Tests on HDMI Source Devices

This section provides procedures for running the *optional* Auto EDID test on HDMI source devices.

The HDMI Auto-EDID Test is included only if you have purchased the Auto EDID Test option.

10.1 HDMI Auto EDID Test

The Auto EDID Test enables you to verify that an HDMI source (or upstream HDMI network) properly handles a series of EDIDs. The test checks the incoming timing against what is expected based on the contents of the EDID such as the preferred timing. The test also verifies that the video parameters are consistent with the capabilities of the EDID that is emulated. The 780C is configured with a set of EDIDs that it will emulate on its HDMI Rx port. The EDIDs can be commercial EDIDs, test EDIDs or even known-bad EDIDs. The HDMI source is connected to the HDMI Rx port and the test is initiated. The results are presented on the embedded screen. As an option you can define a report for later viewing and dissemination to other colleagues and subject matter experts.

10.1.1 Procedures for Configuring a Set of EDIDs for the Auto EDID Test

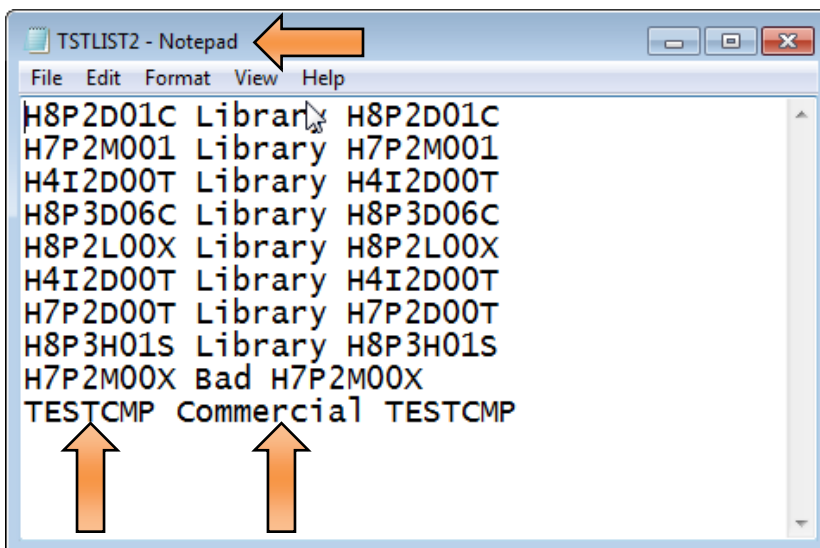
This subsection provides procedures for configuring the 780C with the desired set of EDIDs for testing. Note that the test comes with a default set of EDIDs for running the test. However, typically you will want to create your own set of test EDIDs. You will have to create a text file with the names (and descriptions) of the EDIDs that you wish to use for testing.

Quantum Data offers an [EDID Library](#) free of charge which has a variety of EDIDs for use in testing. The EDID Library provides details procedures on how to download and install EDIDs on a PC. The procedures below assume that you have a set of EDIDs on your PC that you wish to use for the Auto EDID test. This procedure also assumes that you have transferred those EDIDs into the EDID directory of the 780C. Refer to the section in this manual [Adding Reference EDIDs for Use in Testing HDMI Devices](#) for instructions on transferring EDIDs into the proper directory of the 780C.

1. Open up your favorite text editor program (example Notepad). Create a text file listing the EDIDs. Each EDID listing in the file is structured as follows:

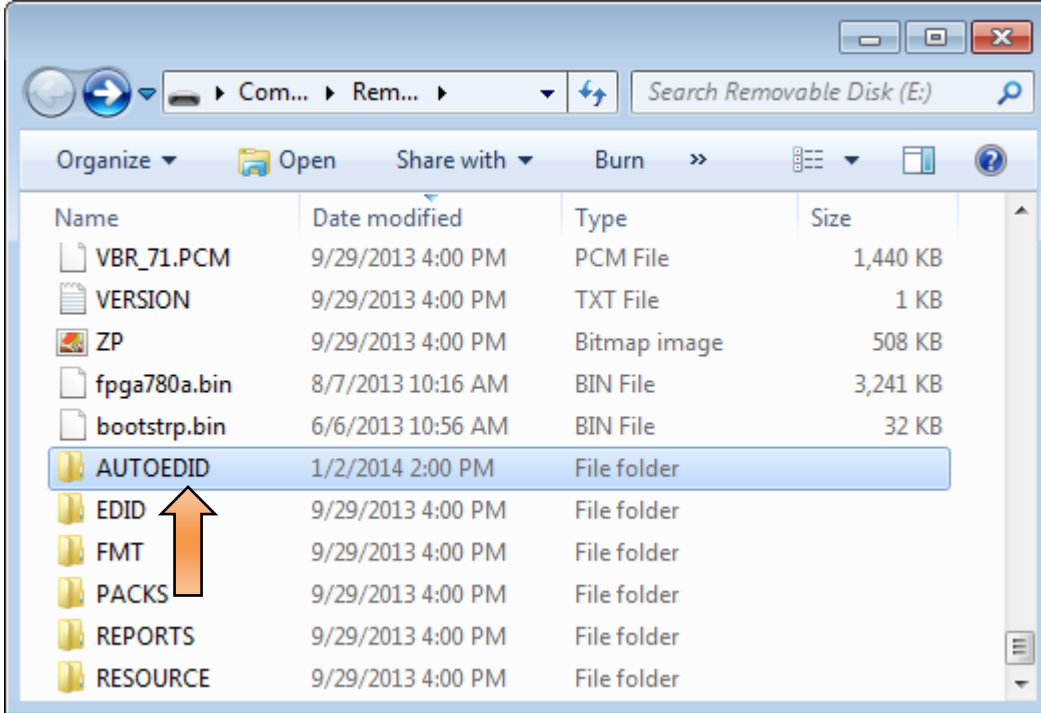
```
<name> <description>
```

Where name is the name of the EDID as it appears in the 780C file system and description is the name you assign and appears in the Name field on the Auto EDID test results screen. The following is an example of the text file:

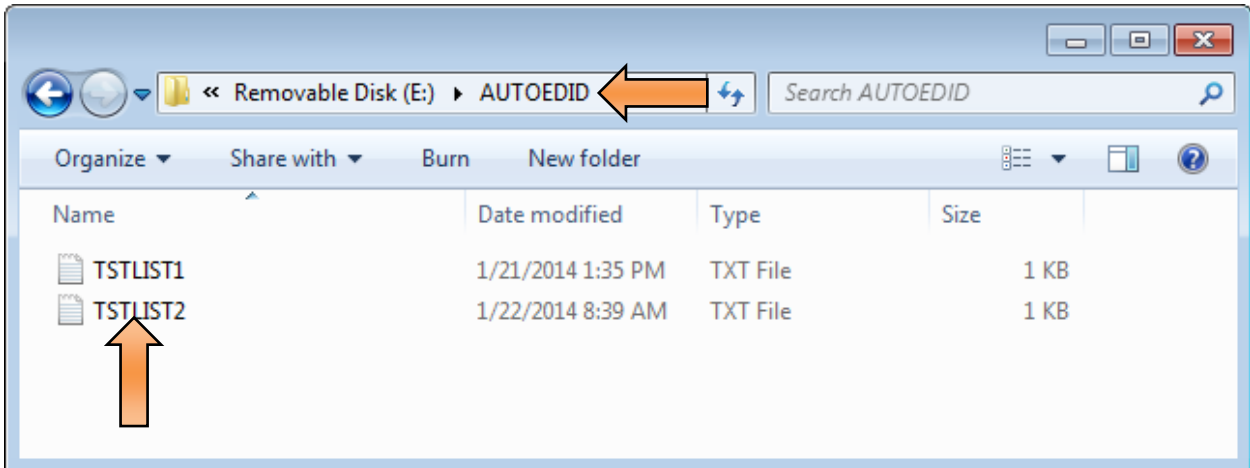


Note: In the example above the first white space separates the name of the EDID which matches the EDID file in the 780C for testing and the description that appears on the AutoEDID test screen. The second white space is part of the description.

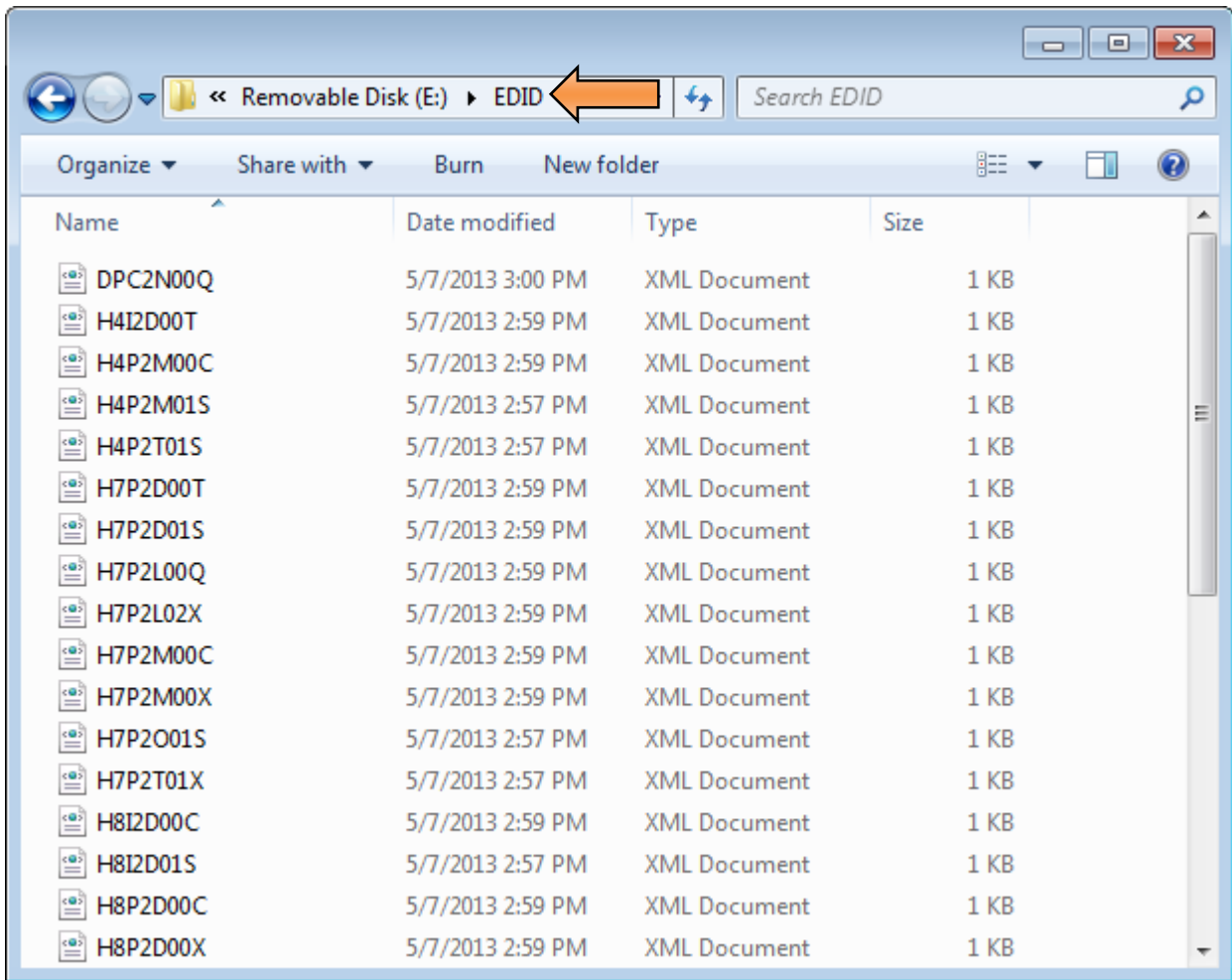
2. Transfer this text file to the AutoEDID directory of the 780C. Use the procedures in [Procedures for Importing EDIDs into the 780C](#) to transfer the this text file to the 780C. Refer to the figure below for reference on the AutoEDID directory.



The AutoEDID directory should now include your EDID list file:

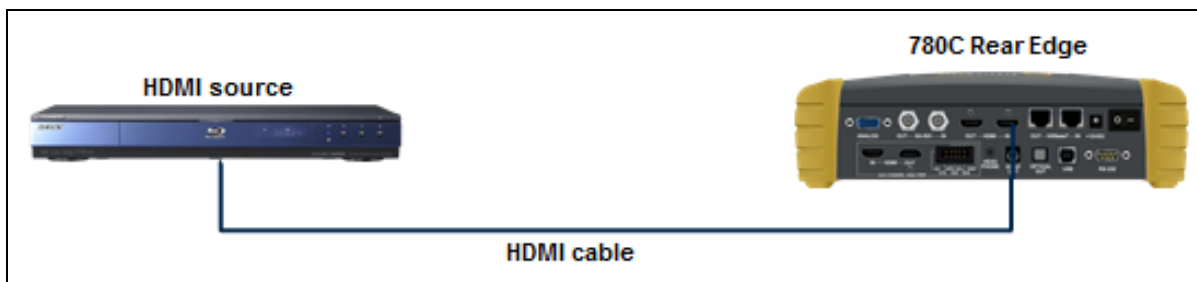


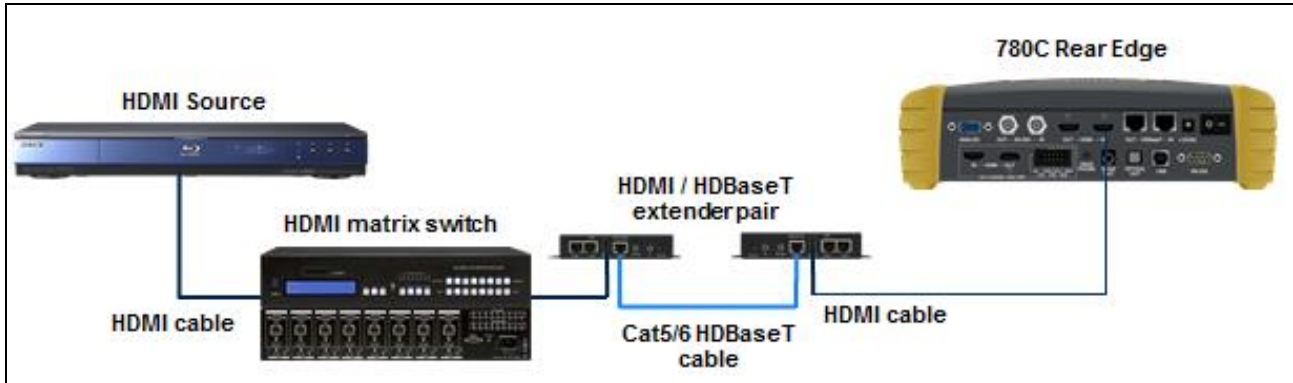
The EDID directory would look similar to the following:



10.1.2 Configurations for Running an Auto EDID Test

This subsection provides configurations supported when performing an HDMI Auto EDID test on a source device which could be an entire upstream HDMI network.



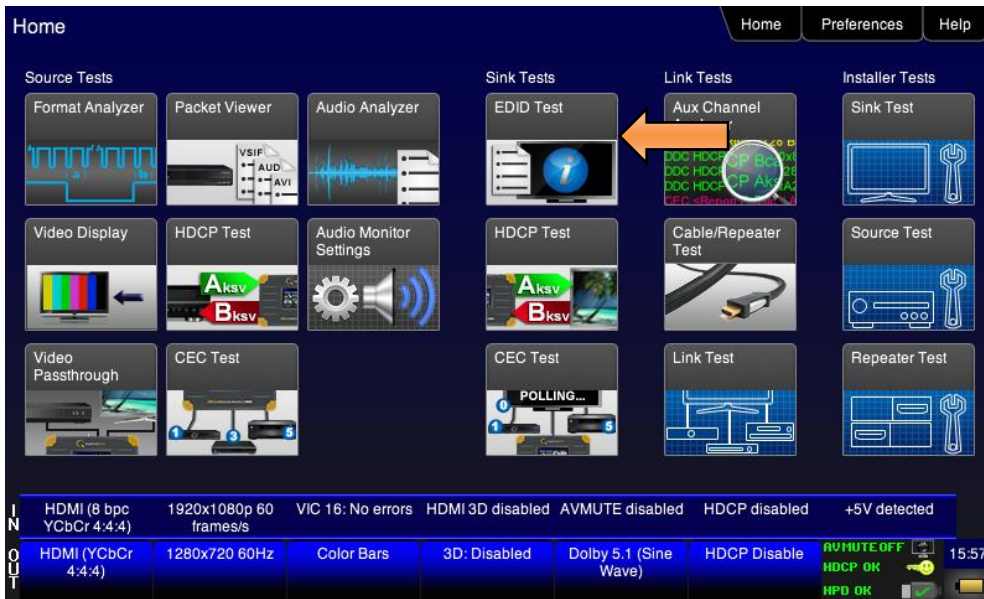


10.1.3 Procedures for Running the Auto EDID Test

This subsection provides procedures for running the optional Auto EDID Test on an HDMI source or upstream network. The procedure assumes that you have the EDIDs saved on the 780C and also the AutoEDID test list file using the procedures above. The procedures also assume that you have the source device connected to the 780C's HDMI Rx port.

Important Note: If you wish to run the optional text report, you will have to have installed a suitable SDCard into the 780C at the SDCard input on the front edge. You will have to *install the SDCard before you boot up the 780C* and run the test.

1. From the **Home** screen touch select the **EDID Test** application on the **Sink Test** region.



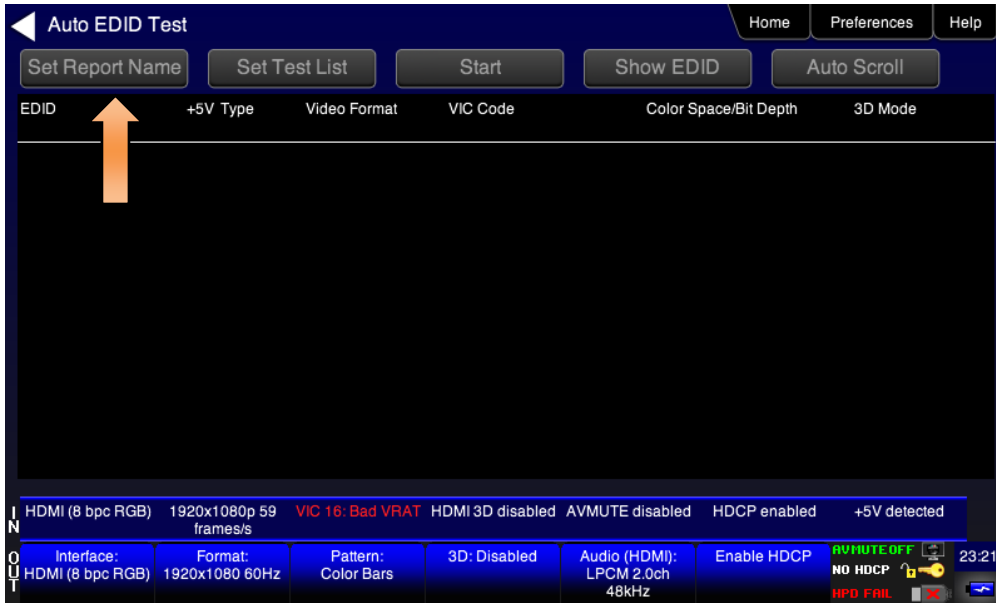
The **EDID Test** screen appears.

- From the **EDID Test** screen, touch select **Auto-EDID Test** as shown below.



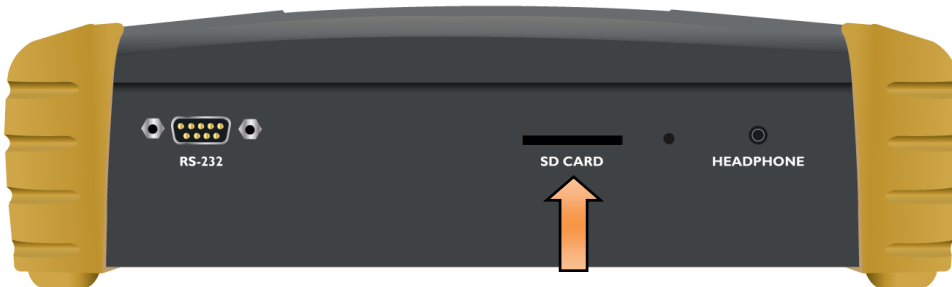
The **Auto-EDID Test** screen appears.

- From the **Auto-EDID Test** screen optionally select **Set Report Name** as shown below.



A Virtual Keyboard screen appears enabling you enter a name for the report. This screen is shown in the next step in this procedure.

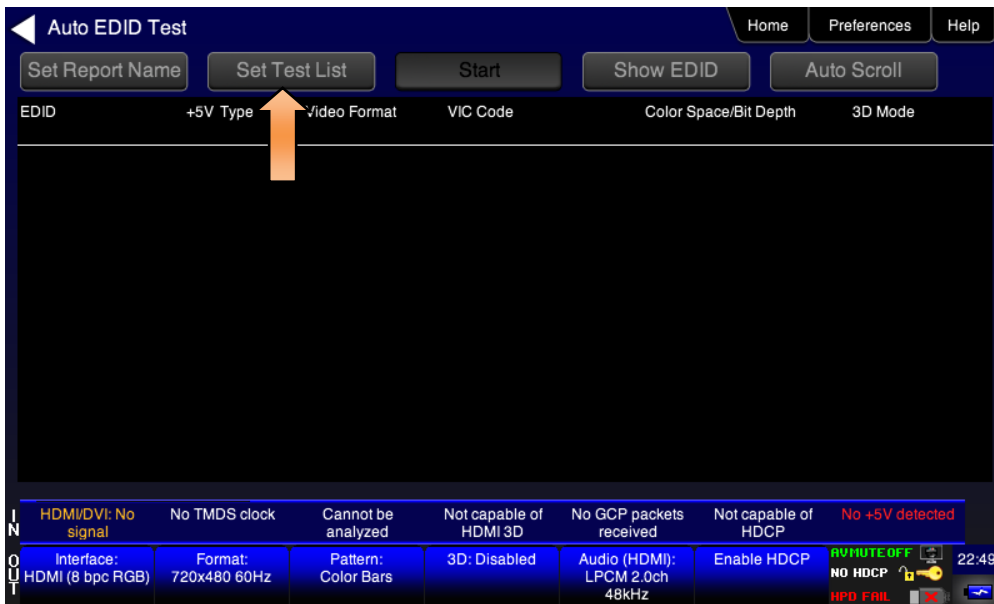
Important Note: You will have to have installed a suitable SDCard into the 780C at the SDCard input on the front edge. Refer to the image below. You will have to *install the SDCard before you boot up the 780C* and run the test. If you have not installed the SDCard. Install the SDCard now, power cycle the 780C and repeat the previous steps.



4. (Optional) If you wish to create a report, enter a name for the report using 8.3 naming convention. Touch select the **Enter** key when you are finished entering the name. An example is shown below:



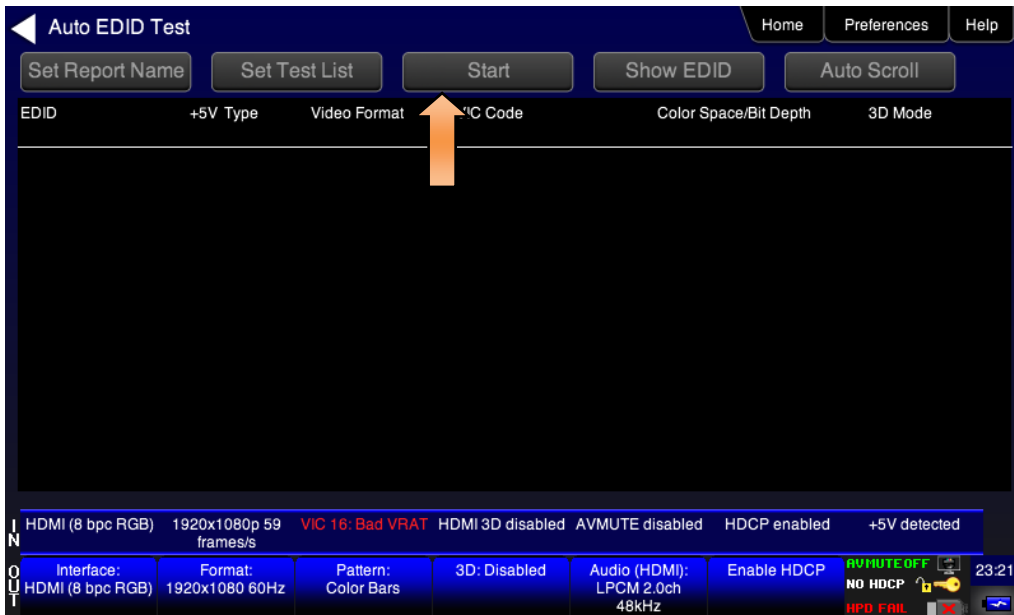
- 5. (Optionally) Touch select the **Set Test List** activation button if you wish to use your specific list of EDIDs for testing.

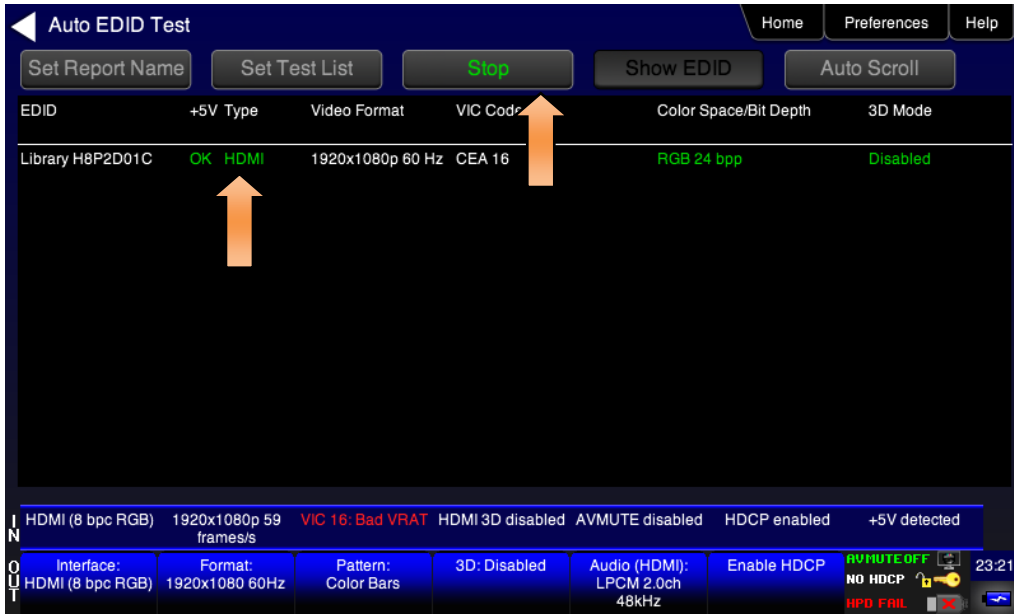


The **Auto Test Lists** screen will appear enabling you to select your previously defined test list. Refer to the screen below.



- 6. Select the desired EDID test list as shown in the screen above.
- 7. Initiate the test with the **Start** button as shown below.





The test will begin executing and you will see the results one by one as each EDID it tested. The following screen shows another example. Note that you can stop the test anytime by touch selecting the **Stop** activation/toggle button (indicated above).

The following screen shows an example of a completed report:



Notes on the example above:

Red text in the example above, indicates anomalous conditions in the handling of an EDID.

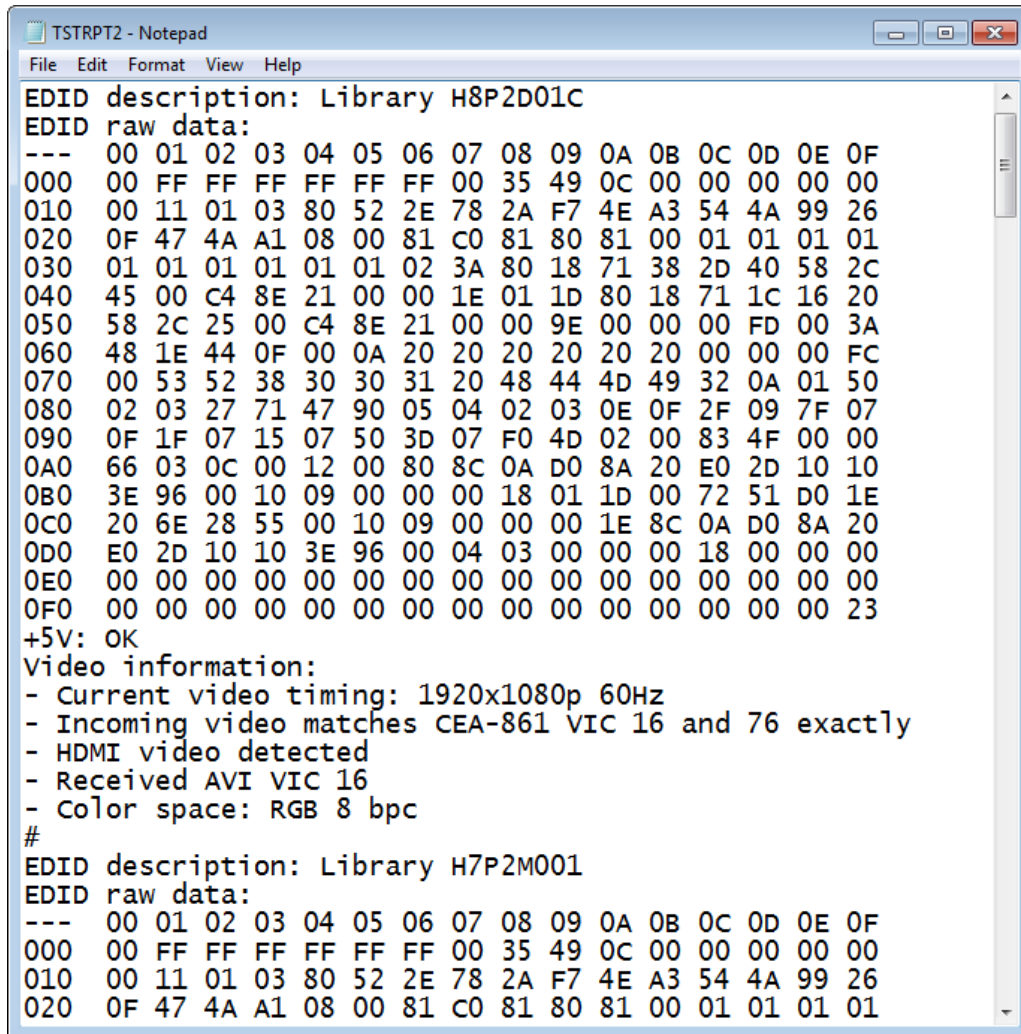
Examples show:

1. Incoming video timing resolution is not present in EDID (2 cases).
2. EDID with bad checksum where incoming video is interpreted as DVI (since there are no infoframes).

10.1.4 Viewing the Auto-EDID Test report.

This subsection discusses viewing of the AutoEDID test text report. The test report is a text file stored on the SDCard that you inserted in the SDCard slot. You will need an SDCard reader or an SDCard slot on your PC to

view the text report. You can view the Auto-EDID test report directly from the SDCard or transfer it to your PC. An example of the report is shown below.



```

TSTRPT2 - Notepad
File Edit Format View Help
EDID description: Library H8P2D01C
EDID raw data:
--- 00 01 02 03 04 05 06 07 08 09 0A 0B 0C 0D 0E 0F
000 00 FF FF FF FF FF FF 00 35 49 0C 00 00 00 00 00
010 00 11 01 03 80 52 2E 78 2A F7 4E A3 54 4A 99 26
020 0F 47 4A A1 08 00 81 C0 81 80 81 00 01 01 01 01
030 01 01 01 01 01 01 02 3A 80 18 71 38 2D 40 58 2C
040 45 00 C4 8E 21 00 00 1E 01 1D 80 18 71 1C 16 20
050 58 2C 25 00 C4 8E 21 00 00 9E 00 00 00 FD 00 3A
060 48 1E 44 0F 00 0A 20 20 20 20 20 20 00 00 00 FC
070 00 53 52 38 30 30 31 20 48 44 4D 49 32 0A 01 50
080 02 03 27 71 47 90 05 04 02 03 0E 0F 2F 09 7F 07
090 0F 1F 07 15 07 50 3D 07 F0 4D 02 00 83 4F 00 00
0A0 66 03 0C 00 12 00 80 8C 0A D0 8A 20 E0 2D 10 10
0B0 3E 96 00 10 09 00 00 00 18 01 1D 00 72 51 D0 1E
0C0 20 6E 28 55 00 10 09 00 00 00 1E 8C 0A D0 8A 20
0D0 E0 2D 10 10 3E 96 00 04 03 00 00 00 18 00 00 00
0E0 00 00 00 00 00 00 00 00 00 00 00 00 00 00 00
0F0 00 00 00 00 00 00 00 00 00 00 00 00 00 00 23
+5V: OK
Video information:
- Current video timing: 1920x1080p 60Hz
- Incoming video matches CEA-861 VIC 16 and 76 exactly
- HDMI video detected
- Received AVI VIC 16
- Color space: RGB 8 bpc
#
EDID description: Library H7P2M001
EDID raw data:
--- 00 01 02 03 04 05 06 07 08 09 0A 0B 0C 0D 0E 0F
000 00 FF FF FF FF FF FF 00 35 49 0C 00 00 00 00 00
010 00 11 01 03 80 52 2E 78 2A F7 4E A3 54 4A 99 26
020 0F 47 4A A1 08 00 81 C0 81 80 81 00 01 01 01 01

```

You can disseminate the test report to subject matter experts or colleagues.

11 Creating and Using Custom Formats, EDIDs, Bitmaps and Menus

This chapter provides procedures on creating and using custom formats, EDIDs, bitmaps and Menus.

11.1 Creating and Using Custom Formats

You can also create your own formats using the Quantum Data Format Editor available at: www.quantumdata.com/downloads. The Format Editor will create an .xml format file that you can store in the 780C. The instructions for using the Format Editor are included with the 882 User Guide also available on at: www.quantumdata.com/downloads. Once created you can load your custom formats either through the command line or by selecting them through the User buttons on the Signal Type menu.

11.1.1 Workflow for Using Custom Formats

In order to import and use custom formats in the 780C you must take the following high level steps (detailed procedures are provided further below):

- Create custom formats with the Quantum Data Format Editor available from www.quantumdata.com/downloads page. The instructions for using the Format Editor are provided in the 882 User Guide also available from www.quantumdata.com/downloads page.
- Store the .xml format files on your PC.
- Place the 780C's USB interface in the **Disk** mode. This is not the default mode for the USB interface.
- Transfer the .xml format file(s) to the FMT directory of 780C over the USB interface.
- Establish a command line session with the 780C from your PC over the USB port.
- Select the custom format through the User Signal Type menu.
- Apply the custom formats using the FMTL and FMTU commands.

11.1.2 Procedures for Creating and Loading Custom Formats

Use the following procedures to add custom formats to your 780C.

1. Create a new custom format or modify an existing formats with the Quantum Data Format Editor. You can use some of the sample formats available from the Quantum Data website as a starting point for creating a new format. Be sure to save the file. The format files will be saved as .xml files by the Format Editor.
2. Select the **Preferences** from the 780C top level menu.

The following screen will appear:



3. Choose **Disk** mode.

The Disk selection for **USB Mode** in the above screen will be highlighted in green.

4. Power cycle the 780C using the rocker switch on the back panel.

The 780C will appear as a mass storage device on your PC like any other USB drive.

Note: If this is the first time you have used the 780C in the **Disk** mode you will have to reformat the disk. The system will prompt you through the format process.

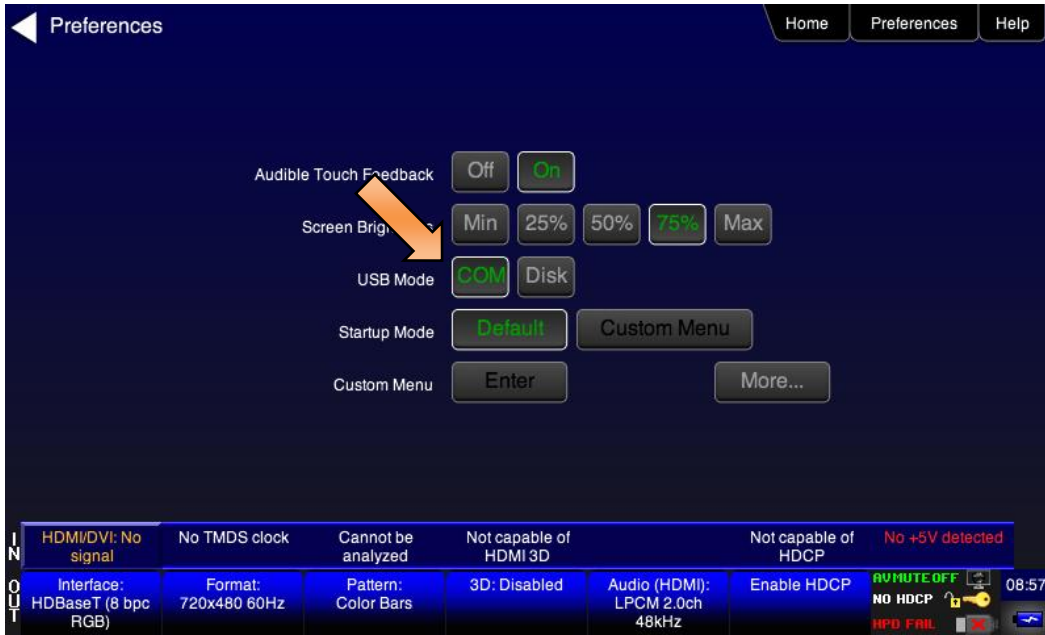
5. Connect the 780C to a PC host via the USB cable provided.

The 780C should appear as a USB storage device.

6. Transfer your custom format .xml files from your PC to the FMT directory of the 780C using standard Windows methods for transferring files to a USB drive, i.e. by dragging and dropping or copying and pasting.

Note: Your formats are limited to 8 characters with an extension (.xml).

7. Touch select the **Preferences** from the 780C top level menu. Refer to the screen below.



8. Touch select **COM** for the **USB Mode** (refer to the screen above).
9. Power cycle the 780C.
10. Navigate to the **Signal Type** menu of the desired interface and select **User-Defined** for the Format Type as indicated below.



The following screen appears which shows the list of custom formats.



11. (Alternatively) Establish a command line session with the 780C from your PC using the procedures described in [Procedures for Enabling the Command Line Interface](#).
12. Load a custom format using the following commands:

```
FMTL <formatName> // where formatName is the name of the custom format
FMTU
```

11.2 Adding Reference EDIDs for Use in Testing HDMI Devices

You can import EDIDs for use in testing HDMI source and sink devices. You can compare a reference EDID stored in the 780C with the EDID of an HDMI sink device the 780C is connected to. You can also test HDMI source devices to test how they will respond to a variety of EDIDs you have stored in the 780C.

11.2.1 Workflow for Importing EDIDs into the 780C

In order to import and use EDIDs in the 780C you must take the following high level steps (detailed procedures are provided further below):

- Place the 780C’s USB interface in the **Disk** mode. This is not the default mode for the USB interface.
- Create.xml EDID files using Quantum Data EDID Editor utilities available with the 882 or the 980. You can use the EDID Editor utility provided with the 980 Manager application available from the Quantum Data website on the downloads page at: www.quantumdata.com/downloads.
- Transfer the .xml EDID file(s) to the EDID directory of 780C over the USB interface.
- Navigate to EDID Test screen to view and use the EDIDs

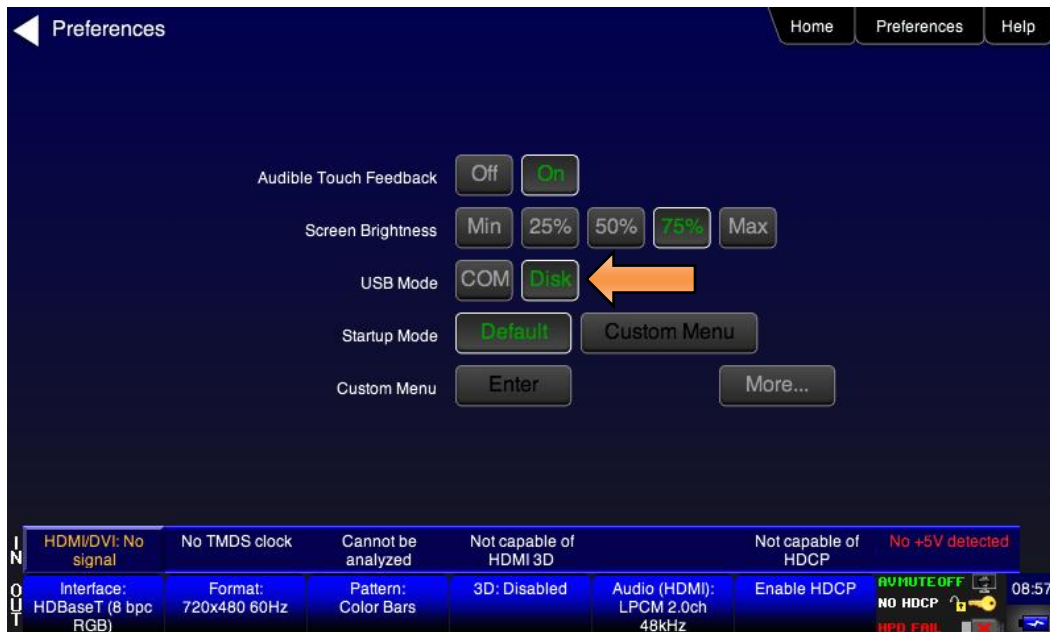
Alternatively you can load an EDID from an HDMI sink device and store its EDID for use as a reference EDID in the EDID compare test. Procedures for this feature are also provided below.

11.2.2 Procedures for Importing EDIDs into the 780C

Use the following procedures to add custom EDIDs to your 780C.

1. Create a new custom EDID or modify an existing EDID with the Quantum Data EDID Editor. Be sure to save the file. These will be saved as .xml files by the EDID Editor.
2. Select the **Preferences** from the 780C top level menu.

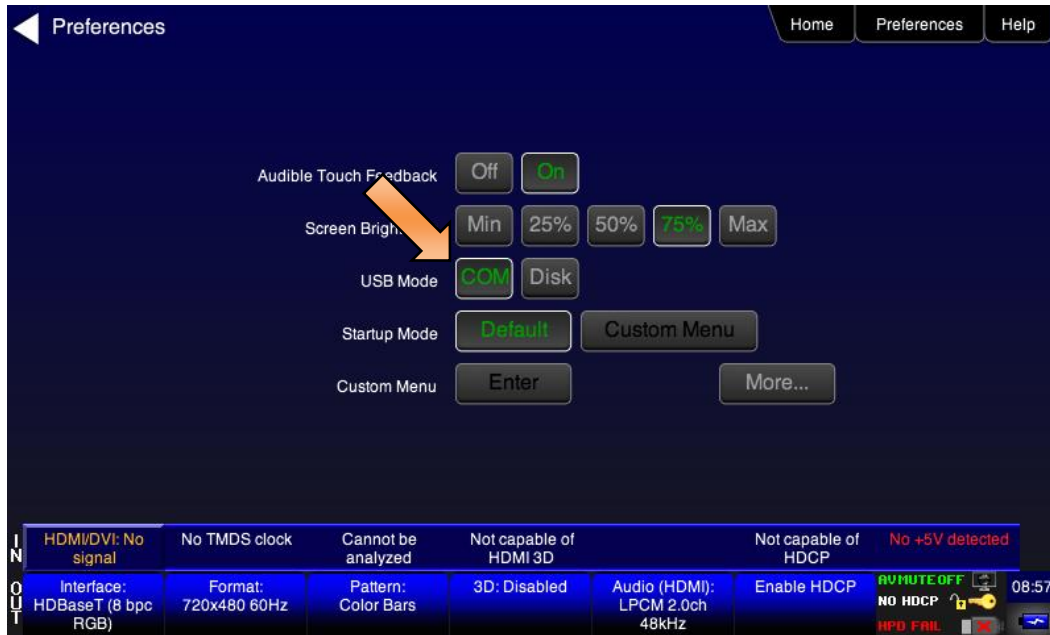
The following screen appears:



3. Choose **Disk** mode.

The Disk selection for **USB Mode** in the above screen will be highlighted in green.

4. Power cycle the 780C using the rocker switch on the back panel.
The 780C will appear as a mass storage device on your PC like any other USB drive.
Note: If this is the first time you have used the 780C in the **Disk** mode you will have to reformat the disk. The system will prompt you through the format process.
5. Connect the 780C to a PC host via the USB cable provided.
The 780C should appear as a USB storage device.
6. Transfer your custom EDID .xml files from your PC to the **EDID** directory of the 780C using standard Windows methods for transferring files to a USB drive, i.e. by dragging and dropping or copying and pasting.
Note: Your EDID names are limited to 8 characters with an extension (.xml).
7. Touch select the **Preferences** from the 780C top level menu. Refer to the screen below.

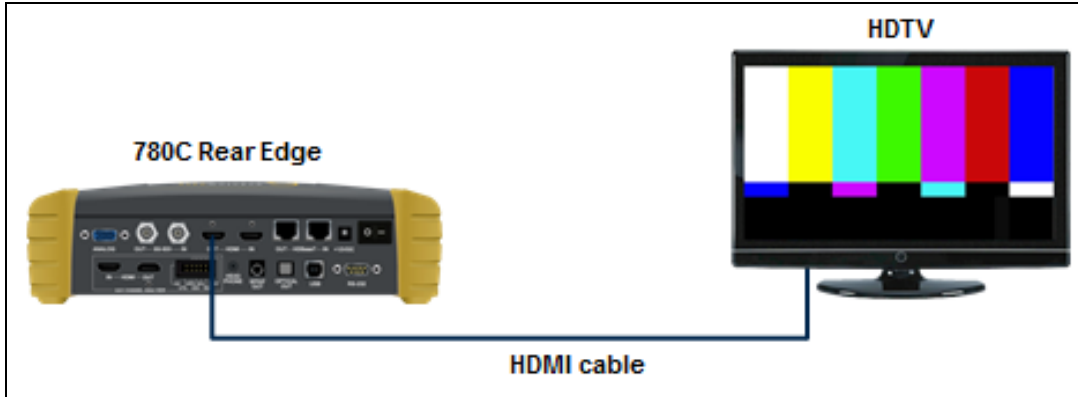


8. Touch select **COM** for the **USB Mode** (refer to the screen above).
9. Power cycle the 780C.
10. Navigate to the **EDID Test** menu.
You should now see the new EDIDs on the list.

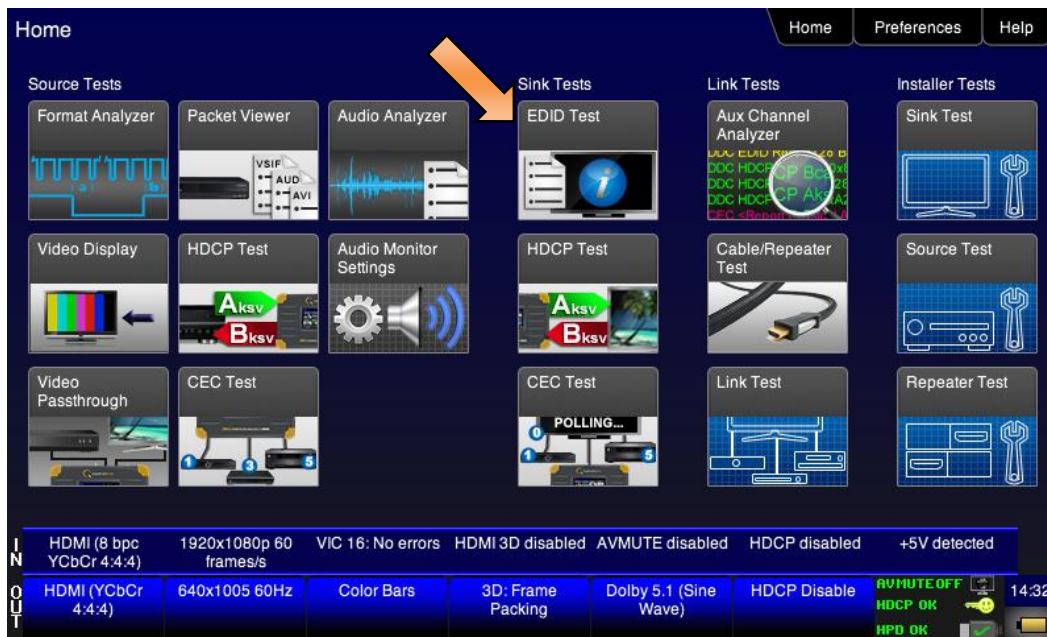
11.2.3 Procedures for Saving an EDID into the 780C

Use the following procedures to add an EDID to your 780C from a connected HDMI sink device.

1. Make the physical connections between the 780C **HDMI** or **HDBaseT OUT** connector and the display device whose EDID you wish to store.



2. Enable the HDMI output using the procedures at [Selecting a Signal Type and Resolution](#).
3. Touch select **EDID Test** from the **Home** menu shown below.



4. Touch select the Read activation button from the **EDID Test** menu shown below.

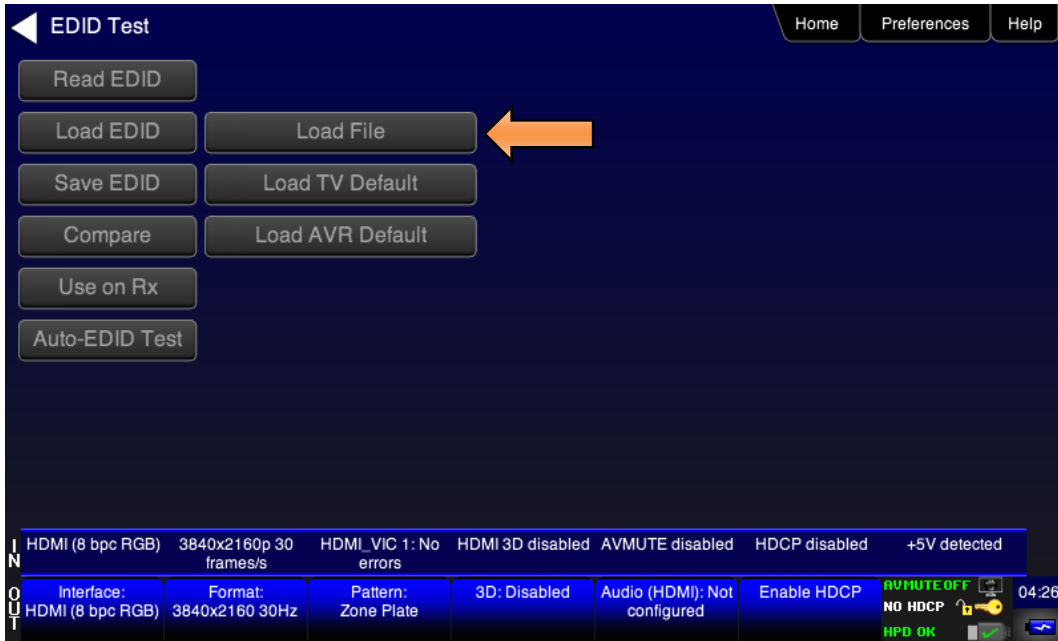
The EDID information is presented on multiple pages on the display. An example of a page of the EDID listing is shown below. You scroll through all the pages using the scroll bar at the right side of the listing.



5. Touch select the **Save** activation button from the **EDID Test** menu shown below. A keypad appears as shown below allowing you to save the EDID to a file.



6. Spell out a name for the EDID (limit 8 characters) by touch selecting the virtual keys (e.g. above “MYEDID”). Then touch select the **Enter** key.
7. Power cycle the 780C.
8. Navigate to the EDID Test screen and touch select **Load** from the **EDID Tests** menu. The following screen results.



9. Touch select the **Load File** option to view your new EDID.



11.3 Using Custom Bitmaps

You can import your own bitmaps into the 780C through the USB interface or load them from an SD card. Note that when bitmaps are imported into the 780C, they are **rendered at their native resolution, i.e. they do not scale** to the resolution of the video format you have selected as the standard test patterns do. Therefore, if you want to test with a specific bitmap pattern for each resolution and you want the bitmap to fill the entire display, you would need to import a separate bitmap of that image for each resolution you wish to test.

Note: Bitmap images are RGB and will not display properly on the 3G-SDI output.

The 780C can accommodate up to 50 custom bitmap images in its internal memory and additional bitmaps stored on the SD card.

Important Note: It is highly recommended that you not select bitmap images when outputting compressed audio clips.

11.3.1 Workflow for Importing Bitmaps

In order to import and use bitmaps in the 780C you must take the following high level steps (detailed procedures are provided further below):

- Place the 780C's USB interface in the **Disk** mode. This is not the default mode for the USB interface.
- Create a text file called "UserPats.txt" that lists each bitmap stored for use. The name in the file has to match the name of the bitmap. The procedures below provide an example of this text file.
- Transfer the UserPats.txt file to the 780C over the USB interface.
- Transfer the bitmap(s) over to the 780C flash memory through the USB interface.



11.3.2 Workflow for loading bitmaps from the SD card

In order to load bitmaps from the 780C's SD card you must take the following high level steps (detailed procedures are provided further below):

- Create a text file called "UserPats.txt" that lists each bitmap stored for use. The name in the file has to match the name of the bitmap. The procedures below provide an example of this text file.
- Transfer the UserPats.txt file to the 780C to an SC card using a card reader.
- Insert the SD card into the 780C SD slot on the front.

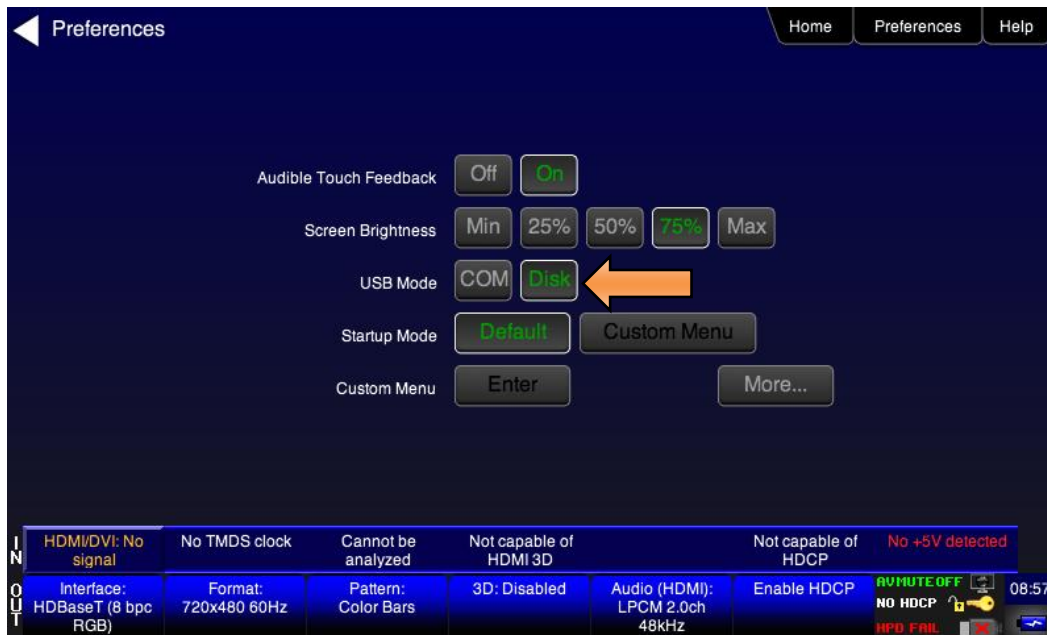
Important notes about SD card use and formatting:

1. The SD card (not an SDHC and not an SDXC).
2. The SD card should be a 1GB or less.
3. The SD card should be formatted using an SD format program available from www.sdcard.org.
4. The SD card must be formatted FAT16.

11.3.3 Procedures for Importing Bitmaps

Use the procedures below to import bitmaps.

1. Connect the 780C to a PC host via the USB cable provided.
2. Select the **Preferences** from the 780C top level menu.



3. Choose **Disk** mode.
The Disk selection for **USB Mode** in the above screen will be highlighted in green.
4. Power cycle the 780C using the rocker switch on the back panel.
The 780C will appear as a mass storage device on your PC like any other USB drive.
5. If this is the first time you have used the 780C in the **Disk** mode you will have to reformat the disk. The system will prompt you through the format process.
6. Create the **userpats.txt** text file listing your bitmaps. Use the information in Table 11-1 below to construct your text file:

Table 11-1: Importing Bitmaps – UserPats.txt file		
Bitmap Name (use 8.3 naming convention)	Bitmap Resolution	UserPats.txt Text File Structure
Mast480.bmp	720x480	The structure of the UserPats file is: <Bitmap Name> space <Description> The contents of the UserPats.txt text file would be: Mast480.bmp Master 720x480 Mast720.bmp Master 1280x720 Mast1080.bmp Master 1920x1080 Note 1: The bitmap name has to match the name of the stored bitmap. Note 2: The description is limited to 20 characters.
Mast720.bmp	128x720	
Mast1080.bmp	1920x1080	

Important Note: It is very important to ensure that the names in the userpats.txt file match the names of the bitmaps.

Example: Given the following bitmap file names:

- Mast720.bmp
- Mast1080.bmp
- MYPLG07.bmp
- MYPLG10.bmp
- MYGEO07.bmp
- MYGEO10.bmp
- MYBRSTS07.bmp
- MYBRSTS 10.bmp

Your userpats.txt file would be something like the following:

Note: Must use 8.3 naming system. Eight (8) characters. The names in the name field (first field) must match the bitmap names.

- Mast720.bmp Master 720
- Mast1080.bmp Master 1080
- MYPLG07.bmp BlkPlug 720
- MYPLG10.bmp BlkPlug 1080
- MYGEO07.bmp Geom178 720
- MYGEO10.bmp Geom178 1080
- MYBRSTS07.bmp RGMultBurst 720
- MYBRSTS10.bmp RGMultBurst 1080

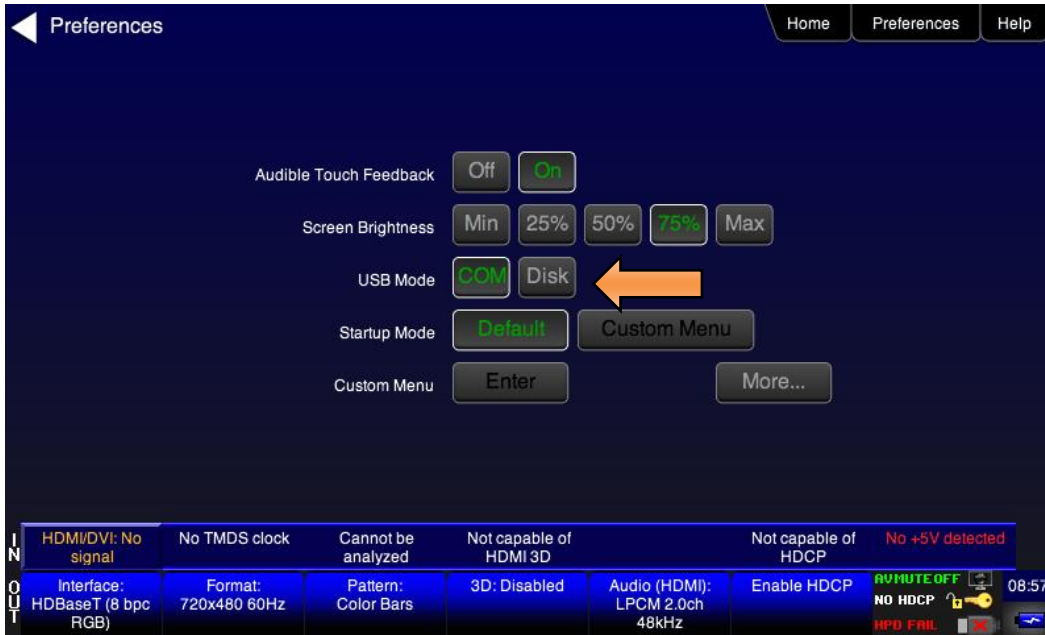
7. Transfer your userpats.txt file from your PC to the 780C using standard Windows methods for transferring files to a USB drive, i.e. by dragging and dropping or copying and pasting.

Note: Your bitmaps are limited to 8 characters with an extension (.bmp).

8. Transfer your bitmap(s) from your PC to the 780C using standard windows procedures for transferring files to a USB drive, i.e. dragging and dropping or copying and pasting.



9. Touch select the **Preferences** from the 780C top level menu. Refer to the screen below.



10. Touch select **COM** for the **USB Mode** (refer to the screen above).
 11. Power cycle the 780C.
 12. Navigate to the **Video Pattern** menu.
- You should now see the new bitmap image(s) on the pattern list (below).



11.3.4 Procedures for Loading Bitmaps from SD Card

Use the procedures below to load bitmaps from an SD card.

1. Load your bitmaps on to the SD card from your PC using a USB SD card reader.
2. Create the **UserPats.txt** text file listing your bitmaps. Use the information in Table 10-2 below to construct your text file:

Table 10-2: Importing Bitmaps – UserPats.txt file		
Bitmap Name (use 8.3 naming convention)	Bitmap Resolution	UserPats.txt Text File Structure

Table 10-2: Importing Bitmaps – UserPats.txt file		
Bitmap Name (use 8.3 naming convention)	Bitmap Resolution	UserPats.txt Text File Structure
Mast480.bmp	720x480	The structure of the UserPats file is: <Bitmap Name> space <Description> The contents of the UserPats.txt text file would be: Mast480.bmp Master 720x480 Mast720.bmp Master 1280x720 Mast1080.bmp Master 1920x1080 Note 1: The bitmap name has to match the name of the stored bitmap. Note 2: The description is limited to 20 characters.
Mast720.bmp	128x720	
Mast1080.bmp	1920x1080	

- Transfer your UserPats.txt file from your PC to the SD card using standard Windows methods for transferring files to a USB drive, i.e. by dragging and dropping or copying and pasting.

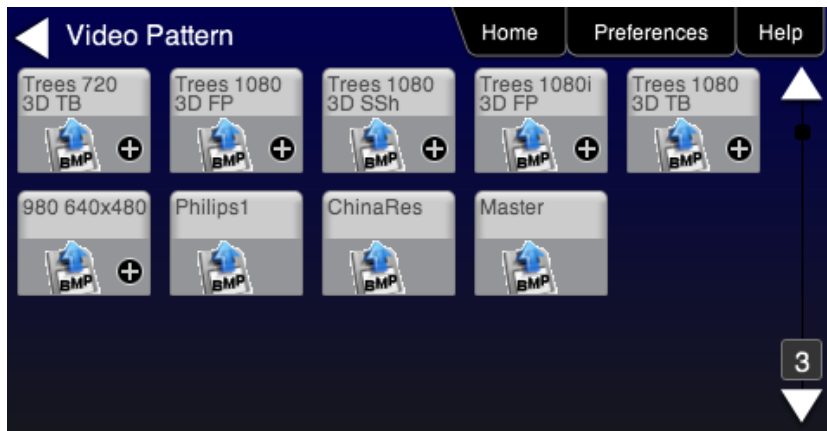
In this example, you would have created a bitmap called for example 980_640.bmp and stored it on the SD card. In this example the bitmap is 640 x 480 resolution. You would then create a userpats.txt file as follows:

- 980_640.bmp 980 640x480

Note: Your bitmaps are limited to 8 characters with an extension (.bmp).

- Insert the SD card into your 780C.
- Power cycle the 780C.
- Navigate to the **Video Pattern** menu.

You should now see the new bitmap image(s) (980 640x480) on the pattern list (below).



11.4 Creating Custom Menus

This section describes how to configure custom menus on the 780C. Custom menus enable you to display a menu of commonly used functions on the 780C touch display. This allows you to save time by quickly executing a specific set of resolution and image combinations.

The custom menus are setup using two text files that you create on your PC and transfer over to the 780C. The two files are: 1) UserKeys.txt and 2) SeqMap.txt. The UserKeys.txt is a set of commands with menu key codes. Each set of commands is a line in the text file.

11.4.1 To create a custom menu:

Use the following procedure to create a custom menu on your 780C.

1. Create a UserKeys.txt file or edit an existing file. An example of a UserKeys.txt file is shown below.

```
#F0 fmtl 720p60;imgl user01;fmtu
#F1 fmtl 1080p60;imgl pgcwrngb;fmtu
#F2 fmtl 480p60;imgl smptebar;fmtu
#F3 fmtl dmt0660;imgl ramp;fmtu
#F4 fmtl 1080i30;imgl focus;fmtu
#FF fmtl dmt0660;imgl smpte;fmtu
```

Note that the commands are separated by a semicolon. In the example above in the first line there is a custom bitmap image “user01” that is used.

2. Create a SeqMap.txt file or edit an existing file. An example of a SeqMap.txt file is shown below.

The SeqMap.txt then maps the commands listed in the UserKeys.txt file to a name and a location on the custom menu. The following is an example of a SeqMap.txt file.

```
#F0 720p Master
#F1 1080p PGCWrgb
#F2 480p SMPTEbar
#F3 DMT0660 Ramp
#F4 1080i Focus
#FF Go Home
```

The result of these two files would be the following custom menu:



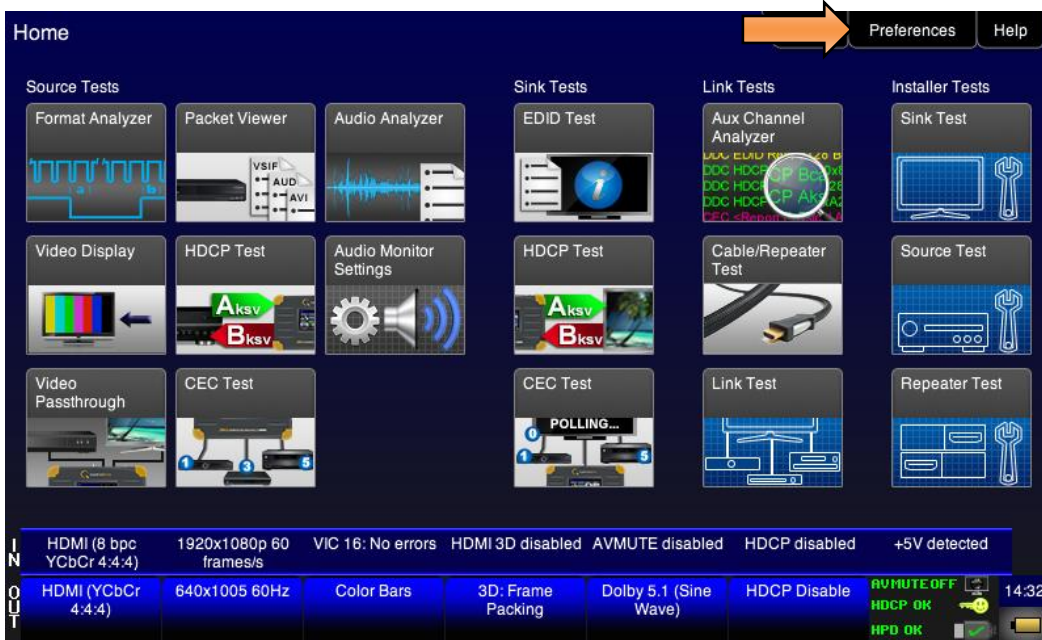
Touch selecting the key labeled “1080p PGCWrgb” would cause the following command sequence to execute:

```
#F1 fmtl 1080p60;imgl pgcwrngb;fmtu // loads 1080p60 format,
                                        displays pgcwrngb test pattern
```

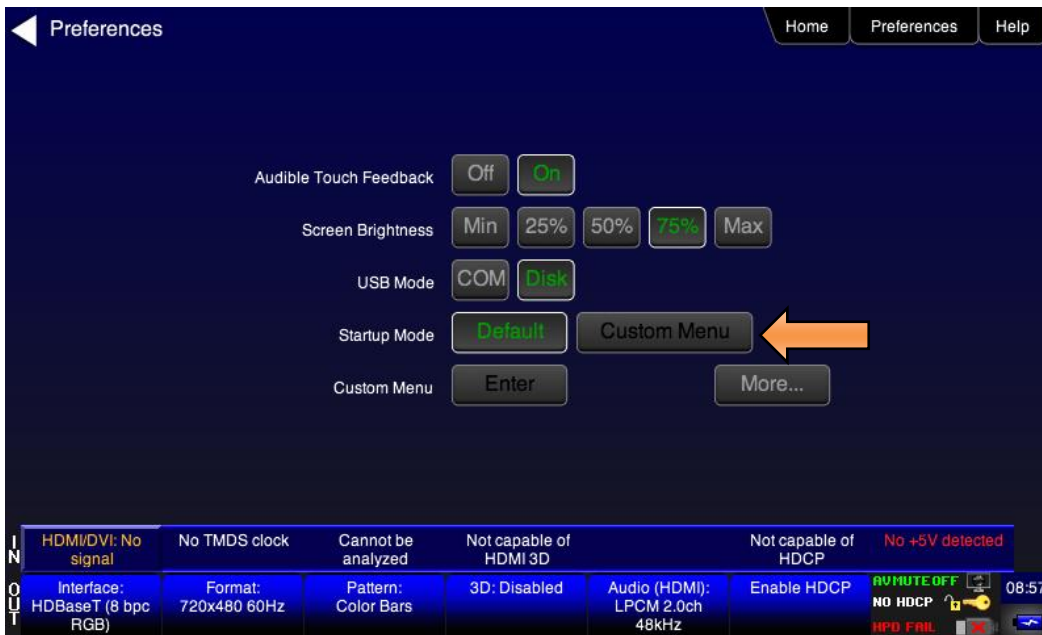
11.4.2 To access custom menus:

Use the following procedure access the custom menu on your 780C.

1. Navigate to the **Preference** menu by selecting the **Preferences** tab from the **Home** menu.



2. Navigate Touch select **Custom Menu** from the Preference screen as shown below.



The following screen appears.



12 Command Interface

This chapter describes how to use the command line to control the 780C. The command line is useful for automated control applications.

12.1 Guidelines for Using the Command Line

The command line is available through the 780C USB port and additionally through an RS-232 connector on the 780C. In order to use the command line through the USB port you need to set the 780C USB port in COM mode. You may need to download an .INF file from the Quantum Data website on the downloads page.

12.2 Procedures for Enabling the Command Line Interface through USB Port

Use the following procedures for command line control of the 780C via the USB port.

Please note if you experience a different behavior on your PC, refer to the 780C release notes on the Quantum Data website at: <http://www.quantumdata.com/downloads/index.asp>.

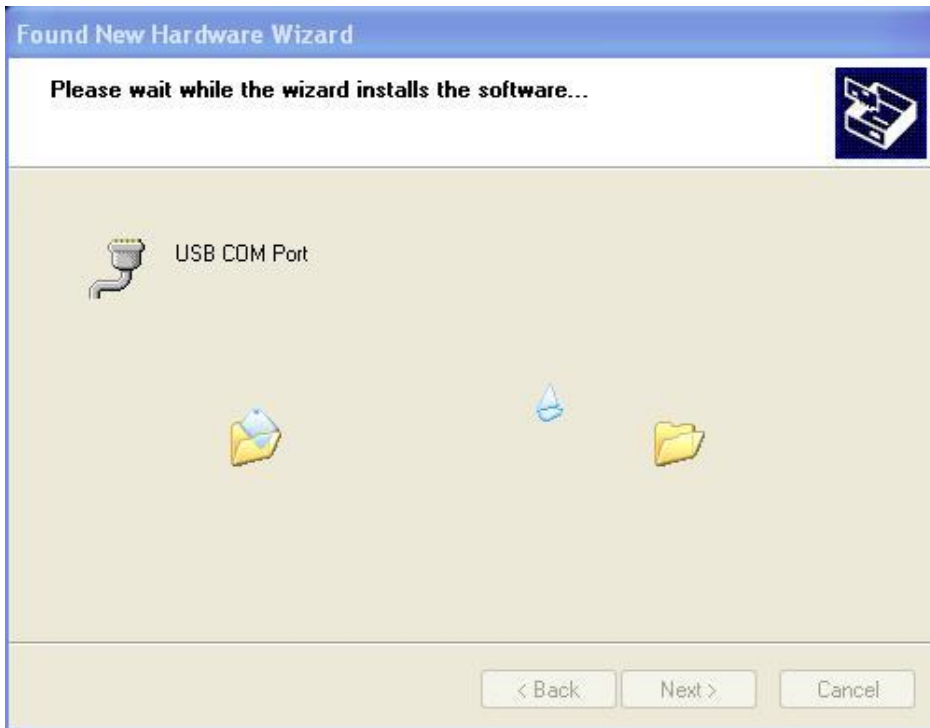
1. Download the .INF file from the Quantum Data website <http://www.quantumdata.com/downloads/index.asp> to your PC and unzip the file. Store it in a convenient location on your PC.
2. Power up the 780C and touch select **Preferences** from the 780C top level menu.
3. Choose **COM** for the **USB Mode** (refer to the screen below).



4. Connect the 780C to your host PC via the USB cable provided.
The first time you connect 780C to your PC in COM mode, the Found New Hardware Wizard will appear.



5. Follow the instructions provided on the dialog box to browse to the location of the .INF file. Once you locate the .INF file the required software will load as shown below.



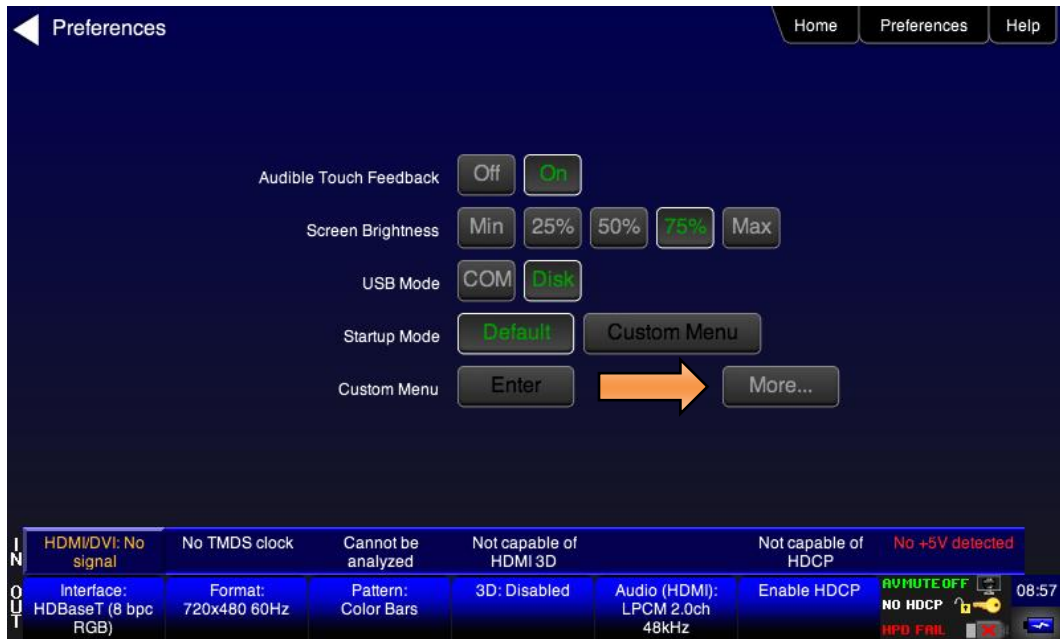
6. Power cycle the 780C.

12.3 Procedures for using the Command Line Interface through RS-232 Port (780C only)

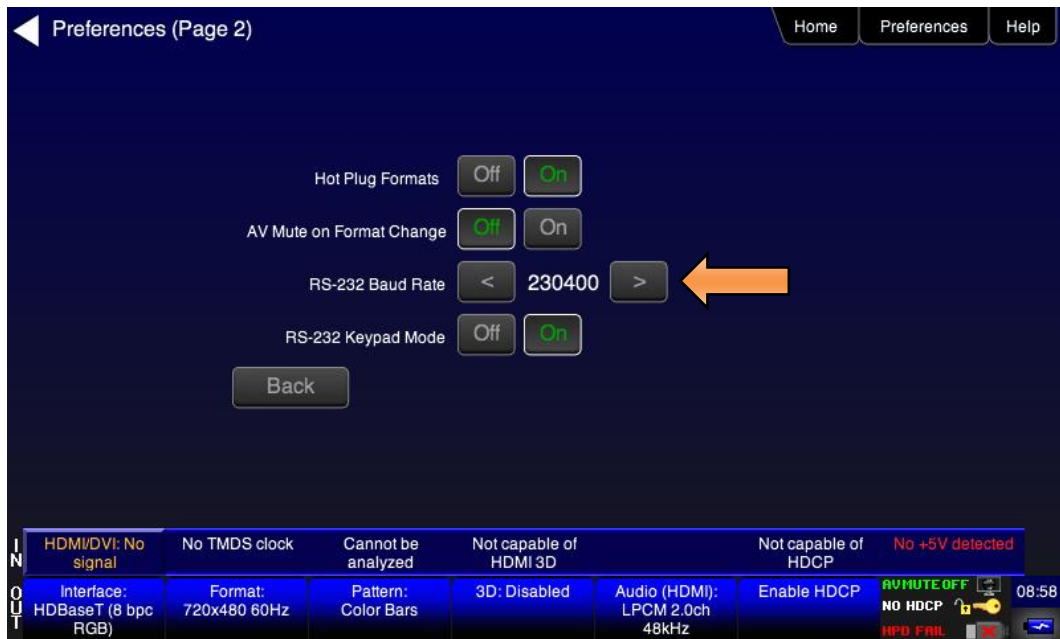
Use the following procedures for command line control of the 780C via the RS-232 serial port.

Please note if you experience a different behavior on your PC, refer to the 780C release notes on the Quantum Data website at: <http://www.quantumdata.com/downloads/index.asp>.

1. Power up the 780C and touch select **Preferences** from the 780C top level menu.
2. Select **More** to view the second Preferences page.



3. Choose the baud rate for the RS-232 port.



4. Connect the 780C to your host PC via an RS-232 cable.
You will have to use a standard RS-232 cable.

12.4 Procedures for Entering Commands

Use the following procedure to connect to the 780C through the USB port.

1. Open up a terminal program such as Hyperterm on your Windows PC. Configure the terminal session with the following settings:
 - Bits per second = 2400, 4800 or 9600
 - Data bits = 8
 - Parity = none
 - Stop bits = 1
 - Flow control = Hardware
2. Press the Return key on your PC and you should receive the **R:\>** prompt.
Now you are ready to enter commands.
3. Use the following tables as a guideline for enter commands.

Note: Changes you make through the command line will not be reflected on the 780C touch panel. For example if you make a selection through the touch panel for the signal type, format and pattern and then override these changes through the command line, the 780C touch screen will still show the selections you made through the touch screen but the interface, format and pattern selections you made through the command line will be active.

Table 12-1 below provides the list of commands supported or testing HDMI sink devices:

Note: The commands are not case sensitive.

Table 12-1: List of Commands (alphabetical) – For Testing HDMI Sink Devices				
Command	Description	Syntax	Parameters	Command Example
ACRG	Enables or disables (“Gates” on or off) the ACR packets sent to a sink.	ACRG <i>0, 1</i> ASSG? < <i>0, 1</i> >	Where <i>1, 0</i> are one of: 0 – disable 1 - enable	To disable ACR packets: ACRG 0 ALLU
ALLU	Activates a change to the video output.	ALLU	Not applicable	To load and invoke a format load command: FMTL 1080i60 ALLU
ASSG	Enables or disables adding composite sync to all three analog components.	ASSG <i>R, G, B</i> ASSG? < <i>R, G, B</i> >	Where <i>R, G, B</i> are one of: 0 – disable 1 - enable	To enable composite sync on green: ASSG 0, 1, 0 FMTU
ASSS	Sets or queries the analog sync signal swing.	ASSS < <i>swing</i> > ASSS?	Where <i>swing</i> is between the range of: min = 0.000 volts max = 0.500 volts	To set the analog sync signal swing: ASSS 0.286 ALLU
AVMG	Sets or clears AVmute on the HDMI output.	AVMG < <i>enable</i> > AVMG?	Where <i>enable</i> is one of: disable = 0 enable = 1	To set avmute: AVMG 1 ALLU

Table 12-1: List of Commands (alphabetical) – For Testing HDMI Sink Devices				
Command	Description	Syntax	Parameters	Command Example
AVMM	Enables or disables AVmute upon format change on the HDMI output.	AVMM <enable> AVMM?	Where <i>enable</i> is one of: disable = 0 enable = 1	To enable avmute on an HDMI format change: AVMM 1 ALLU
AVSS	Sets the maximum peak-to-peak swing for all three analog video channels.	AVSS<level> AVSS?	Where <i>level</i> is between the range of: min = 0.000 volts max = 1.000 volts	To set the analog video type: AVSS 0.9 ALLU
AVST	Selects the analog video format type.	AVST <format_type> AVST?	Where <i>format_type</i> is one of: 2 – Analog RGB 6 - Analog YPbPr	To set the analog video type: AVST 2 ALLU
BKSV?	Shows value of sink device's BKSV (in hex) when connected to 780C Tx	BKSV?	Not applicable	To read a sink device's BKSV: BKSV? 152BDD2533
BOXG	To enable or disable the moving box on an image.	BOXG <enable>	Where <i>enable</i> is: 0 = disable 1 = enable	To enable the moving box: BOXG 1 ALLU
CECx:PING?	Runs a CEC ping test from: the HDMI Tx (x = 1) or the HDMI Rx (x = 2) port.	CECx:PING <LA> <results>	Where x = 0 for the HDMI Rx port and x = 1 for the HDMI Tx port. Where LA = the logical address of the device you want to ping.	To ping an HDTV from the 780C HDMI Tx port: CEC1:PING 00 TV (LA=0) found
CSPG	Enable and disable the digital composite sync outputs when digital composite sync is selected via the SSST command.	CSPG <enable> CSPG?	Where <i>enable</i> is: 0 = disable 1 = enable	To enable digital composite sync: SSST 2 CSPG 1 ALLU
CSPP	Sets or queries the polarity of the composite sync pulse.	CSPP <polarity> CSPP?	Where <i>polarity</i> is: 0 = active low (negative going) 1 = active high (positive going)	To set the composite sync pulse to a positive going: CSPP 1 FMTU or ALLU

Table 12-1: List of Commands (alphabetical) – For Testing HDMI Sink Devices

Command	Description	Syntax	Parameters	Command Example
DACG	Specifies which audio channels are activated (gated on) for LPCM audio.	DACG <mask>	Where <i>mask</i> is an 8 bit value. Each bit corresponds to a channel with the first bit (bit 0) associated with channel 1, bit 1 for channel 2 and so on to bit 7 corresponding to channel 8. The bit position values are: Bit 0 – Ch 1 = 1 Bit 1 – Ch 2 = 2 Bit 2 – Ch 3 = 4 Bit 3 – Ch 4 = 8 Bit 4 – Ch 5 = 16 Bit 5 – Ch 6 = 32 Bit 6 – Ch 7 = 64 Bit 7 – Ch 8 = 128 You can enable multiple channels.	To enable channel 1 only: DACG 1 ALLU To disable all channels: DACG 0 ALLU To enable all channels: DACG 255 ALLU To enable channel 8 only: DACG 128 ALLU To enable channels 1-6: DACG 127 ALLU
DVSM	Sets or queries the digital video sampling mode. Applies only for HDMI.	DVSM <sampling> DVSM?	Where <i>sampling</i> is one of: 0 – RGB (4:4:4) 2 – YCbCr (4:2:2) 4 – YCbCr (4:4:4)	To set the HDMI sampling mode to RGB (4:4:4): DVST 10 DVSM 0 ALLU
DVST	Sets or queries the digital video type. Applies only for HDMI.	DVST<type> DVST?	Where <i>type</i> is one of: 10 – RGB 14 – YCbCr	To set the HDMI sampling mode to YCbCr (4:4:4): DVST 14 DVSM 4 ALLU
DVQM	Sets or queries the digital video quantizing range. Applies only for HDMI.	DVQM <mode> DVQM?	Where <i>range</i> is one of: 0 – 0-255 (8 bit) 1 – 1-254 (8 bit) 2 – 16-235 (8 bit RGB 16-240 (8 bit YCbCr)	To set the HDMI quantizing range to 0-255: to RGB: DVQM 0 ALLU
EDID?	Shows the EDID (in hex) of the sink device connected to the 780C Tx port.	EDID?	Not applicable	To read a sink device's EDID: EDID? 01FFFFFF01...
FMTL	Loads a format.	FMTL <format>	Where <i>format</i> is one of the formats listed in Table 7-2 and Table 7-3	See example below for FMTU
FMTU	Activates a format that has been loaded and queries for the currently active format.	FMTU FMTU?	Not applicable	To load and invoke a format load command: FMTL 1080i60 FMTU

Table 12-1: List of Commands (alphabetical) – For Testing HDMI Sink Devices				
Command	Description	Syntax	Parameters	Command Example
FRAT?	Queries the frame rate of the outgoing HDMI format.	FRAT?	Not Applicable	To read the frame rate of the outgoing HDMI signal: FRAT? +60.000E+00
HDCP?	Runs an HDCP authentication test on an HDMI sink device	HDCP? <frames>	Number of frames: Where <i>frames</i> is number of frames rounded to the nearest 128 frames. Results: where <i>results</i> are: 0 = pass 1 = fail	To run an HDCP authentication test on an HDMI sink device or repeater device: To run an HDCP test for 128 frames: (pass reported) HDCP? 255 To run an HDCP test for 256 frames: HDCP? 257 0 To run an HDCP test for 512 frames (with a failure reported): HDCP? 1
HPAG?	Query the incoming sink for hot plug pin status.	HPAG? <hotplug>	Where <i>hotplug</i> can be 0 (no hot plug detected) or 1 (hot plug detected)	To check for hot plug on the HDMI Out port: HPAG?
HRAT	Sets the horizontal rate of the video timing.	HRAT <rate> HRAT? <rate>	Where <i>rate</i> can be within the range of: 1000Hz to 130000Hz	To set the horizontal rate to 15000Hz: HRAT 15000 ALLU or FMTU
HRES	Sets the horizontal resolution of the video timing.	HRES <pixels> HRES? <pixels >	Where <i>pixels</i> can be within the range of: 100 to 4000 pixels	To set the horizontal resolution to 1282 pixels: HRES 1282 ALLU
HTOT	Sets the horizontal total number of pixels of the video timing.	HTOT <pixels> HTOT? <pixels >	Where <i>pixels</i> can be within the range of: 100 to 4000 pixels	To set the horizontal total to 1376 pixels: HTOT 1376 ALLU or FMTU
HSPP	Sets of the polarity of the horizontal sync pulse.	HSPP <polarity> HSPP? <polarity>	Where <i>polarity</i> can be within the range of: 0 = high to low transition 1 = low to high transition	To set the horizontal sync pulse polarity to low to high transition: HSPP 1 ALLU or FMTU
HSPW	Sets the horizontal sync pulse width of the video timing in pixels.	HSPW <pixels> HSPW? <pixels >	Where <i>pixels</i> can be within the range of: 1 to HTOT-HRES-HSPD	To set the horizontal sync pulse width to 32 pixels: HSPW 32 ALLU or FMTU

Table 12-1: List of Commands (alphabetical) – For Testing HDMI Sink Devices				
Command	Description	Syntax	Parameters	Command Example
HSPG	Sets enable gate of the horizontal sync pulse.	HSPG <enable> HSPG? < enable >	Where <i>enable</i> is: 0 = disable 1 = enable	To enable the horizontal sync pulse: HSPG 1 ALLU or FMTU
IMGL	Loads an image (pattern).	IMGL <image>	Where <i>image</i> is one of the images listed in Table 7-4	See example below for IMGU
IMGU	Activates an image that has been loaded and queries for the currently active image.	IMGU IMGU?	Not applicable	To load and invoke a image load command: IMGL SMPTEbar IMGU
NBPC	Sets or queries the number of bits per component. Applies only to HDMI	NBPC <bit_depth> NBPC?	Where <i>bit_depth</i> is one of: 8 – 8 bits per component 10 – 10 bit per component 12 – 12 bits per component	To set the HDMI bit depth to 10: NBPC 10 ALLU or FMTU
PRAT?	Queries the pixel rate of the outgoing HDMI format.	PRAT?	Not Applicable	To read the pixel rate of the outgoing HDMI signal: PRAT? +74.2500E+06
RGBW	Sets RGB values on with Raster and Window test patterns	RGBW <pattern> <R> <G> RGBW? <pattern> <R> <G> 	Where <i>pattern</i> is either 4 for Window pattern or 33 for raster pattern. Where <i>R G B</i> are the respective values for the RGB color components	To set the Window pattern to dark brown: imgl window imgu rgbw 4 115 82 68 or rgbw 4 115 87 74
SCAN	Defines whether the active timing is progressive or interlaced or queries the state of the active timing.	SCAN <scan> SCAN? < scan >	Where <i>scan</i> is: 1 = progressive 2 = interlaced	To set the scan to interlaced: SCAN 2 ALLU or FMTU
SIRE	Sets IRE levels for certain images: Window1/2, Raster, Flat_Wht/Grn/Red/Blu/Cyn/Mag/Bik	SIRE <range>	Where <i>range</i> is a value from 0 to 100.	To set the IRE range for any of the images listed: SIRE 50 ALLU
SSST	Sets or queries the sync type. Applies only to analog outputs.	SSST <sync_type> SSST?	Where <i>format_type</i> is one of: 1 – separate sync 3 – sync on green	To set the analog sync type to separate sync: SSST 1 ALLU
VRES	Sets or queries the vertical resolution of the active timing. Express in number of lines.	VRES <lines> VRES? < lines >	Where <i>lines</i> can be within the range of: Min = 1 (if scan = 1) = 2 (if scan = 2) Max = VTOT – 1 (if scan = 1) = VTOT – 3 (if scan = 2)	To set the horizontal resolution: VRES 480 ALLU

Table 12-1: List of Commands (alphabetical) – For Testing HDMI Sink Devices				
Command	Description	Syntax	Parameters	Command Example
VRAT?	Queries the vertical rate (field rate for interlaced formats) of the outgoing video format.	VRAT?	Not Applicable	To read the vertical rate of the outgoing HDMI signal of 1080i30: VRAT? +60.000E+00
VSPD	Sets or queries the vertical sync pulse delay of the active timing. Express in number of lines.	VSPD <lines> VSPD? < lines >	Where <i>lines</i> can be within the range of: Min = 1 (if scan = 1) = 2 (if scan = 2) Max = VTOT – 1 (if scan = 1) = VTOT – 3 (if scan = 2)	To set the horizontal sync pulse delay: VSPD 11 ALLU
VSPW	Sets or queries the vertical sync pulse width of the active timing. Express in number of lines.	VSPW <lines> VSPW? < lines >	Where <i>lines</i> are the number of lines for the vertical pulse width	To set the horizontal sync pulse width: VSPW 3 ALLU
VSPP	Sets the polarity of the vertical sync pulse.	VSPP <polarity> VSPP? <polarity>	Where <i>polarity</i> can be one of: 0 = high to low transition 1 = low to high transition	To set the horizontal sync pulse polarity to low to high transition: VSPP 1 ALLU
VSPG	Enables or disables the vertical sync pulse.	VSPG <enable> VSPG? < enable >	Where <i>enable</i> is: 0 = disable 1 = enable	To enable the vertical sync pulse: VSPG 1 ALLU
VTOT	Sets the vertical total number of lines of the video timing.	VTOT <lines> VTOT? < lines >	Where <i>lines</i> are the total number of lines.	To set the vertical total to 525 lines: VTOT 525 ALLU
XVSI	Selects the interface.	XVSI <interface> XVSI?	Where <i>interface</i> is one of: 2 – DVI (Computer) 3 – DVI (TV) 4 - HDMI 9 – Analog YPbPr or RGB)	To set the interface: XVSI 4 ALLU
XVSG	Determines which video components are active when a format is selected.	XVSG R G B FMTU or ALLU XVSG? R G B	Where <i>R G</i> and <i>B</i> are: R = 0 (Off) or 1 (On) G = 0 (Off) or 1 (On) B = 0 (Off) or 1 (On)	To set gate on or off red, green or blue components: XVSG 1 0 1 (Red On; Green Off; Blue On) ALLU

Table 12-1: List of Commands (alphabetical) – For Testing HDMI Sink Devices				
Command	Description	Syntax	Parameters	Command Example
XAVI	Enables you to send specific parameter values of the AVI infoframes out the HDMI outputs independent of the HDMI video stream parameters.	XAVI:aviparameter <value>	Where aviparameter is one of the values identified below and value is an associated value provided in CEA-861-E. S – Scan information. Sets the scan information value or retrieves the value transmitted. B – Bar information. Sets the bar information value or retrieves the value transmitted. A – Active format information. Sets the active format information value or retrieves the value transmitted. C – Colorimetry. Sets the colorimetry value or retrieves the value transmitted. Y – Video type. Sets the video type value or retrieves the value transmitted. Q – RGB Quantization range. Sets the RGB Quantization range or retrieves the value transmitted. YQ – YCC quantization range. Sets the YCC quantization range or retrieves the value transmitted. R – Active Format Aspect Ratio. Sets active format aspect ratio value or retrieves the value transmitted. M – Picture Aspect Ratio. Sets the picture aspect ratio value or retrieves the value transmitted. EC – Extended Colorimetry. Sets the extended colorimetry value or retrieves the value transmitted. SC – Non-uniform Picture Scaling. Sets the non-uniform picture scaling value or retrieves the value. ETB – Line number at start of top bar. Sets the pixel number start top value or retrieves the value transmitted. SBB – Line number at start of bottom bar. Sets the pixel number start bottom value or retrieves the value transmitted. ELB – Pixel number at start of left bar. Sets the pixel number start left value or retrieves the value transmitted. SRB – Pixel number at start of right bar. Sets the pixel number start right value or retrieves the value transmitted. VIC – Video Identification Code. Retrieves the value transmitted. PR – Pixel repetition. Sets the pixel repetition value or retrieves the value transmitted. ITC – IT Content. Sets the IT content value or retrieves the value transmitted. CN – Content Type. Sets the content type value or retrieves the value transmitted. CSUM – Checksum. Sets the checksum value or retrieves the value transmitted.	To set the scan parameter to overscanned: XAVI:S 1 IFGU To set the video type to RGB and aspect ratio to 4:3: XAVI:Y 0; M 1 IFGU To return the value of the video parameter type: XAVI:Y?

Table 12-1: List of Commands (alphabetical) – For Testing HDMI Sink Devices

Command	Description	Syntax	Parameters	Command Example
XAUD	Enables you to send specific parameter values of the AUD infoframes out the HDMI output independent of the HDMI audio stream.	<i>XAUD:audparameter <value></i>	Where <i>audparameter</i> is one of the values identified below and <i>value</i> is an allowed value associated with the parameter provided in CEA-861-E. CA – Channel assignment. Sets the channel assignment value or retrieves the value transmitted. CC – Channel count. Sets the channel count value or retrieves the value transmitted. CT – Audio coding type. Sets the audio coding type value or retrieves the value transmitted. SS – Sample size. Sets the sample size value or retrieves the value transmitted. SF – Sampling frequency. Sets the sampling frequency value or retrieves the value transmitted. DMI – Down-mix inhibit. Sets the down-mix inhibit value or retrieves the value transmitted. LSV – Level shift value. Sets the level shift value or retrieves the value transmitted. PBL – LFE playback level. Sets the LFE playback level or retrieves the level transmitted. CSUM – Checksum. Sets or gets the checksum value for the corresponding InfoFrame.	To set the channel count to 3: <i>XAUD:CC 2</i> <i>IFGU</i> To set the sampling size to 24: <i>XAUD:SS 3</i> <i>IFGU</i> To return the value of the channel count parameter type: <i>XAUD:CC?</i>
XHVI	Enables you to send specific parameter values of the Vendor Specific infoframe out the HDMI output independent of the HDMI stream.	<i>XHVI:hviparameter <value></i>	Where <i>hviparameter</i> is one of the values identified below and <i>value</i> is an allowed value associated with the parameter provided in CEA-861-E. HVF – HDMI Video Format field. Values: 0 = no info, i.e. 2D; 1 = 4Kx2K; 2 = 3D. HVIC – HDMI Video Identification Code (VIC). Sets VIC for 4Kx2K use. H3DS– HDMI 3D structure. Sets the 3D structure indication. 3DMG – 3D metadata present gate. Indicates whether 3D metadata is present or not present. 3DED – 3D External data. LEN – HDMI VSIF length in bytes. CSUM – Checksum. Sets or gets the checksum value for the corresponding InfoFrame.	To enable 3D: <i>XHVI:HVF 2</i> <i>IFGU</i> To indicate that 3D metadata is present: <i>XHVI:3DMG 2</i> <i>IFGU</i> To query if 3D metadata is present: <i>XHVI:3DMG?</i>

Table 12-1: List of Commands (alphabetical) – For Testing HDMI Sink Devices				
Command	Description	Syntax	Parameters	Command Example
XSPD	Enables you to send specific parameter values of the Source Product Descriptor infoframe out the HDMI output independent of the HDMI stream.	XSPD: <i>spdparameter</i> <value> Where <i>spdparameter</i> is one of the values identified below and <i>value</i> is an allowed value associated with the parameter provided in CEA-861-E. XSPD [VNS [PDS [SDI]] Where: XSPD – Vendor string name. PDS – Product description string. SDI – Source device information (see EIA/CEA-861-E standard)		To assign a vendor string name: XSPD QDI HDMI-Analyzer IFGU To query the vendor string name: XSPD?
Note: The commands are not case sensitive.				

Table 12-2 below provides the list of commands supported or testing HDMI sink devices:

Note: The commands are not case sensitive.

Table 12-2: List of Commands (alphabetical) – For Testing HDMI Audio in Sink Devices				
Command	Description	Syntax	Parameters	Command Example
ARAT	Sets the audio rate on Optical, SPDIF and HDMI LPCM audio.	ARAT <i>rate</i> ARAT? < <i>rate</i> >	Where <i>rate</i> is one of: 32000, 44100, 48000, 88200, 96000, 176400, 192000.	To set the audio sampling rate to 48kHz: ARAT 48000 FMTU
SAMP	Sets the amplitude on either a specific channel or channels.	SAMP < <i>amp</i> > < <i>ch</i> > SAMP? < <i>amp</i> > < <i>ch</i> >	Where <i>amp</i> is between the range of: min = -99 dB max = 0 dB Where <i>ch</i> is in one of: 0 - 7	To set the amplitude of the audio signal on channel 1 (FR) to -3dB: SAMP -3 1 FMTU To set the amplitude of the audio signal on all channels to -6dB: SAMP -6 FMTU
SRAT	Sets the sine wave frequency on either a specific channel or all channels.	SRAT < <i>rate</i> > < <i>ch</i> > SRAT? < <i>rate</i> > < <i>ch</i> >	Where <i>rate</i> is between the range of: min = 8Hz max = 20000Hz Where <i>ch</i> is in one of: 0 - 7	To set the sinewave frequency of the audio signal on channel 1 (FL) to 2000 Hz: SRAT 2000 0 FMTU To set the sinewave frequency of the audio signal on all channels to 4000Hz: SRAT 4000 FMTU

Table 12-2: List of Commands (alphabetical) – For Testing HDMI Audio in Sink Devices				
Command	Description	Syntax	Parameters	Command Example
NBPA	Sets the number of bits per sample in the SPDIF, Optical and HDMI PCM audio.	NBPA <bits> NBPA? <bits>	Where <i>bits</i> is one of: 16, 20, 24	To set the audio bit depth to 24: NBPA 24 FMTU
NDAC	Sets the number of digital audio channels for an LPCM audio signal.	NDAC <channels> NDAC? <channels>	Where <i>channels</i> is: 2 or 8	To set the number of channels to 8: NDAC 8 FMTU
DASI	Sets the digital audio interface.	DASI <interface> DASI? <interface>	Where <i>interface</i> is one of: 0 = disabled 1 = SPDIF 4 = Optical 6 = HDMI	To set the digital audio interface to HDMI: DASI 6 FMTU

Table 12-3 below provides the list of commands supported or testing HDMI source devices:

Table 12-3: List of Commands – For Testing HDMI Source Devices			
Command	Description	Syntax	Command Example
AKSV?	Shows value of source device's AKSV (in hex) when connected to 780C Rx.	AKSV?	To read a source device's AKSV: AKSV? 152BDD2533
AUDA	Queries the Audio Clock Regeneration (ACR) N and CTS values received from a source.	AUDA:N? AUDA:CTS?	To view the N value from a source: AUDA:N? 458779

Table 12-3: List of Commands – For Testing HDMI Source Devices			
Command	Description	Syntax	Command Example
AUDA:RPTP?	Queries the audio infoframe and channel status bits and issues a text report.	AUDA:RPTP?	To view the audio infoframe and channel status bits: AUDA:RPTP? Audio InfoFrame data: Channel count: 2 channels Coding type: 0 (Refer to stream header) Word length: Refer to stream header Sampling freq.: Refer to stream header Channel allocation: --- --- --- --- --- --- FR FL Channel status bits: Application: Consumer Sample words: LPCM Copyright asserted: Yes Format info: Default Mode: 0 Category code: 00 Source number: 0 Channel number: 0 Sampling freq.: 48 KHz Word length: 24 bits
CECx:PING?	Runs a CEC ping test from: the HDMI Tx (x = 1) or the HDMI Rx (x = 2) port.	CECx:PING <LA> <results> Where x = 0 for the HDMI Rx port and x = 1 for the HDMI Tx port. Where LA = the logical address of the device you want to ping.	To ping an HDTV from the 780C HDMI Tx port: CEC1:PING 00 TV (LA=0) found
CPAG	Enables or disables HDCP on the HDMI Rx port.	CPAG <enable> CPAG? Where enable is: 0 = disable 1 = enable	To disable HDCP on the HDMI Rx port: CPAG 0 ALLU
DIDL	Loads an EDID file into memory in preparation to apply it to the Rx port with the DIDU command.	DIDL <file.xml> Where file.xml is an EDID file stored in the 780C memory.	To load an EDID file and apply it to the Rx port: DIDL my720p.xml DIDU

Table 12-3: List of Commands – For Testing HDMI Source Devices			
Command	Description	Syntax	Command Example
DIDU	Applies an EDID file loaded with DIDL to the Rx and issues a hot plug pulse. Note: can be used in conjunction with the HPPW command to produce hot plug pulses of varying widths.	DIDU	To load an EDID file, apply it to the Rx port and issue a hot plug pulse: DIDL my720p.xml DIDU
HPPW	Sets the hot plug pulse width.	HPPW <pulse> HPPW? <pulse>	Where <i>pulse</i> can be within the range of: 100 to 4000 milliseconds
IFAU	Reads infoframes.	IFAU	Not applicable
IFAD?	Displays the contents of a specific type of infoframe.	IFAU IFAD? <infoframe packet>	Where <i>infoframe packet</i> is the header number assigned to the infoframe type in the HDMI specification: - VSIF = 81 - AVI = 82 - SPD = 83 - AUD = 84 - MPEG = 85
TMAU	Invokes timing analyzer.	TMAU	To initiate a timing test: TMAU Note: Then use one or more of the TMAX commands below.
TMAX:HTOT?	Reads horizontal total pixels.	TMAX:HTOT?	To read horizontal total pixels: TMAX:HTOT?
TMAX:HRES?	Reads horizontal active pixels.	TMAX:HRES?	To read horizontal active pixels: TMAX:HRES?
TMAX:HSPD?	Reads horizontal sync pulse delay	TMAX:HSPD?	To read horizontal sync pulse delay: TMAX:HSPD?
TMAX:HSPW?	Reads horizontal sync pulse width	TMAX:HSPW?	To read horizontal sync pulse width: TMAX:HSPW?
TMAX:VTOT?	Reads vertical total pixels (lines)	TMAX:VTOT?	read vertical total pixels (lines): TMAX:VTOT?
TMAX:VRES?	Reads vertical active pixels (lines)	TMAX:VRES?	To read vertical active pixels (lines): TMAX:VRES?
TMAX:VSPD?	Reads vertical sync pulse delay	TMAX:VSPD?	To read vertical sync pulse delay: TMAX:VSPD?
Note: The commands are not case sensitive.			

Table 12-4 below provides the list of commands supported for testing HDMI source devices:

Table 12-4: List of Commands – For Testing HDMI Cables and Distribution Networks			
Command	Description	Syntax	Command Example
CBLT?	Cable Test. Runs pseudo random noise error test on the TMDS R,G,B channels of an HDMI cable.	CBLT? < <i>x errors</i> > Where <i>x errors</i> is the number of errors detected on R, G and B channels.	To run a pseudo random noise error test on the TMDS R,G,B channels of an HDMI cable: CBLT? 0 errors
CBL2?	Runs continuity test on +5V, Hot Plug and DDC leads in an HDMI cable.	CBL2? <+5v results> >Hot Plug results> <DDC results> Where +5V results, hot plug results and DDC results indicate Pass or Fail for each lead or lead pair.	To run a cable test on the +5V, DDC and hot plug leads: CBL2? +5v: PASS Hot Plug: PASS DDC: PASS

Table 11-5 below provides the list of commands supported for running the Frame Compare test:

Table 12-5: List of Commands – For Testing Distribution Networks with the Frame Compare Test			
Command	Description	Syntax	Command Example
PDAX:CAPF	Initiates the capture of a reference frame for the Frame Compare test.	PDAX:CAPF	To capture a reference frame: PDAX:CAPF
PDAX:FRMS	Specifies the number of frames to capture during the Frame Compare test.	PDAX:FRMS < <i>frames</i> > Where <i>frames</i> are the number of frames that you want to capture and compare to the reference frame. Valid values are 0-250. Default value is 10. You can query the current value with: PDAX:FRMS?	To specify that 100 incoming frames will be used to compare with the reference frame: PDAX:FRMS 100
PDAX:REFG	Enables or disables auto reference capturing for the Frame Compare test. If this parameter is disabled you have to manually capture a reference frame.	PDAX: REFG < <i>enable</i> > Where <i>enable</i> is either 0 to disable or 1 to enable auto reference capturing. Default value is 0 to disable. You can query the current value with: PDAX: REFG?	To enable auto reference capturing: PDAX: REFG 1

Table 12-5: List of Commands – For Testing Distribution Networks with the Frame Compare Test

Command	Description	Syntax	Command Example
PDAU	Initiates the capture of the number of frames specified by the PDAX:FRMS command and compares those frames with the captured reference frame.	PDAU	To capture a reference frame and compare 100 of incoming frames to the reference frame: PDAX:CAPF PDAX:FRMS 100 PDAU
PDAX:ERRQ?	Returns the number of pixel errors that occurred during the comparison.	PDAX:ERRQ?	To query for the number of errors following the pixel error comparison (PDAU): PDAX:ERRQ?

Table 12-6 below lists the format names, their resolutions and frame rates for television formats. For command line control you would use the format name as the argument for the FMTL command.

Table 12-6: List of HDTV Format Names for Command Line Applies to: HDMI, DVI (TV), Analog YPbPr Video Signal Types			
Syntax for Format Name	Resolution	Frame Rates (Hz)	Command example
480i[frame rate] e.g.: 480i29	H: 720; V: 480	29.97, 30, 59.94, 60, 119.88, 120	FMTL 480i60 FMTU
480p[frameRate] e.g.: 480p59	H: 720; V: 480	59.94, 60, 119.88, 120	FMTL 480p60 FMTU
576i[frame rate] e.g.: 576i25	H: 720; V: 576	25, 50, 100	FMTL 576i25 FMTL
576p[frameRate] e.g.: 576p50	H: 720; V: 576	50, 100	FMTL 576p50 FMTU
720p[frameRate] e.g.: 720p25	H: 1280; V: 720	24, 25, 29.97, 30, 59.94, 60, 100, 119.88, 120	FMTL 720p60 FMTU
1080i[frameRate] e.g.: 1080i25	H: 1920; V: 1080	25, 29.97, 30, 50, 59.94, 60	FMTL 1080i59 FMTU
1080p[frameRate] e.g.: 1080p30	H: 1920; V: 1080	25, 29.97, 30, 50, 59.94, 60	FMTL 1080p60 FMTU

Table 12-7 lists some of the format names for computer formats. For command line control you would use the format name as the argument for the FMTL command as shown in the example

Note: The following table *only shows a sample of some of the more common formats*. The other names can be obtained from the list on the 780C itself.

Table 12-7: Partial List of Computer Format Names for Command Line Applies to: DVI (Computer) Analog RGB Video Signal Types	
Format Name	Command example
640x480_72Hz	FMTL 640x480_72Hz FMTU
800x600_56Hz	FMTL 800x600_56Hz FMTU
1024x768_60Hz	FMTL 1024x768_60Hz FMTU
1280x768_60Hz	FMTL 1280x768_60Hz FMTU
1280x1024_60Hz	FMTL 1280x1024_60Hz FMTU
1600x1024_60Hz	FMTL 1600x1024_60Hz FMTU
1920x1440_60Hz	FMTL 1920x1440_60Hz FMTU

Table 12-8 below lists the image names. For command line control you would use the image name as the argument for the IMGU command.

Table 12-8: List of Image parameter names for command line					
Image Name	Example	Image Name	Example	Image Name	Example
SMPTEBar	IMGL SMPTEBar IMGU	Regulate	IMGL Regulate IMGU	Flat_Yel	IMGL Flat_Yel IMGU
H_Stair (Horizontal)	IMGL H_Stair IMGU	Checker (6x6)	IMGL Checker IMGU	Flat_BlK	IMGL Flat_BlK IMGU
Pluge	IMGL Pluge IMGU	Focus	IMGL Focus IMGU	Crosshtch (Grid)	IMGL Crosshtch IMGU
Needle	IMGL Needle IMGU	Multibrst	IMGL Multibrst IMGU	Anmorphic	IMGL Anmorphic IMGU
HiLoTrk (White Pluge)	IMGL HiLoTrk IMGU	SplitGray (11 vertical bars)	IMGL SplitGray IMGU	GrayBar	IMGL GrayBar IMGU
Overscan	IMGL Overscan IMGU	LG_V_CBAR (Vertical bars)	IMGL LG_V_CBAR IMGU	Staircase	IMGL Staircase IMGU
Window1 (30 IRE)	IMGL Window1 IMGU	LG_H_CBAR (Horiz bars)	IMGL LG_H_CBAR IMGU	PulseBar	IMGL PulseBar IMGU
Window2 (80 IRE)	IMGL Window2 IMGU	V_3BARS (UL 3 bar pattern)	IMGL V_3BARS IMGU	Rev_Grid	IMGL Rev_Grid IMGU

Table 12-8: List of Image parameter names for command line					
Image Name	Example	Image Name	Example	Image Name	Example
Raster	IMGL Raster IMGU	Flat_Wht	IMGL Flat_Wht IMGU	Linearity	IMGL Linearity IMGU
DecodAdj (Color Adjust)	IMGL DecodAdj IMGU	Flat_Red	IMGL Flat_Red IMGU	PRN24Bit (pseudo noise)	IMGL PRN24Bit IMGU
DecodChk (Color Decode)	IMGL DecodChk IMGU	Flat_Grn	IMGL Flat_Grn IMGU	ZonePlate (Moving zone plate)	IMGL ZonePlate IMGU
ColorBar (75 IRE)	IMGL ColorBar IMGU	Flat_Blu	IMGL Flat_Blu IMGU	User00/24 (User bitmaps)	IMGL User01 IMGU
Ramp	IMGL Ramp IMGU	Flat_Cyn	IMGL Flat_Cyn IMGU	Aux Combo Test	IMGL AuxTest IMGU
Converge	IMGL Converge IMGU	Flat_Mag	IMGL Flat_Mag IMGU		

13 Using the Keypad

This section provides information and procedures for operating the 780C with a keypad. The 780C can support keypad operation to enable efficient production test operation. An RS-232 numeric keypad is used for this application. Supported keypad functions include selection of interface, timing, pattern, and test sequences.

13.1 Connecting a Keypad

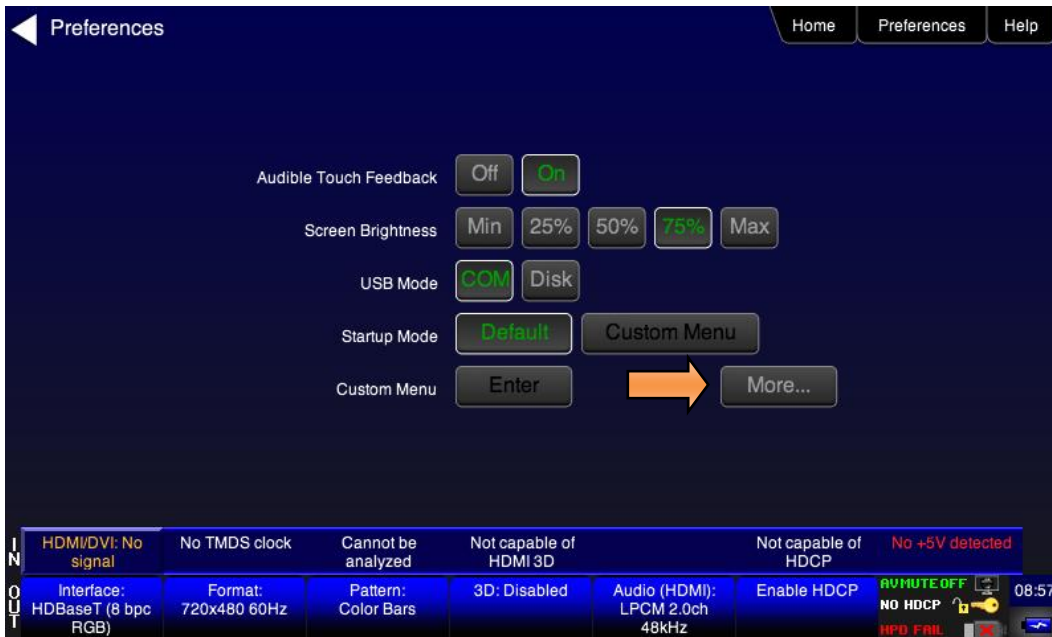
A serial terminal keypad can be connected to the 780C front edge RS-232 connector.



13.2 Enabling and Configuring an RS-232 Keypad

The RS-232 keypad must be enabled and configured from the 780C **Preferences** menu. Use the following procedures to enable a keypad.

1. From the 780C **Home** menu, select the **Preferences** tab. The **Preferences** menu will be displayed as shown below.



2. Navigate to the second page using the **More** button.



3. For the **RS-232 Keypad Mode** menu item, select the ON button. When selected, the ON button will be highlighted green.
4. Under **RS-232 Baud Rate**, use the arrow keys to select the correct baud rate for the keypad to be used. For the Genovation keypad supplied by Quantum Data, choose 1200 baud. After selecting the correct baud rate, power-cycle the 780C so that the changes take effect.

13.3 Keypad Functionality

For keypad support, the 780C uses four configuration files stored in the root directory of the internal flash. Here are the names and functions of the four files:

- **UserKeys.txt:** This file provides mappings of key codes so that the 780C knows which key has been pressed. This file may be different for each model of keypad that is used. This file should be configured by Quantum Data Engineering, and should not be changed by the customer unless you wish to create a specific test sequence. Procedures for creating a test sequence in the UserKeys.txt file are provided further below. Please contact Quantum Data Applications Engineering if you need this file changed, or if you want to use a different model of keypad.
- **fmtmap.txt:** This file provides mapping of format numbers to specific formats on specific interfaces. Each interface has a range of format numbers associated with it, and these ranges are specified in file intmap.txt. An example of the mapping for this file is depicted in Table 13-2.
- **intmap.txt:** This file specifies the ranges of format numbers assigned to each video interface. An example of the mapping for this file is depicted in Table 13-3.
- **imgmap.txt:** This file provides a mapping of test pattern numbers to the actual test patterns. An example of the mapping for this file is depicted in Table 13-4.

Keypad functions are assigned as shown in Table 13-1 below:

Table 13-1 – Keypad Functions	
Key	Function
Num Lock	Timing - Select a format
/	Pattern - Select an image
*	Program – Create a sequence

September 3, 2014	Revision A1
-------------------	-------------

. or Del	Out or End
-	Go to Previous item
+	Go to Next item

13.4 Selecting a Format (Timing)

A format can be selected by pressing the TIMING key followed by the number that represents the desired timing and interface. The following is an example of how you would select a format using the Format Map file shown in Table 13-2 below. Table 13-3 further below shows a sample mapping between formats (timings) and interfaces.

TIMING
 352
 ENTER

This will change the timing format to 1080p60 on the HDMI interface. Then the “Previous” and “Next” keys can be pressed to sequence through the format list. The following table is an example of a map between formats and keypad numbers that you would select.

Table 13-2 – Example Format Map File		
Format Number	Format Name	Interface-Specific
301	NTSC44	TV
302	NTSC-J	
303	NTSC-M	
304	PAL-BDGH	
305	PAL-N	
306	PAL-NC	
307	PAL-M	
308	PAL-60	
310	480i30	BNC (YPbPr)
311	576i25	
312	480p59	
313	576p50	
314	720p60	
315	720p59	
316	720p50	
317	1035i30	
318	1035i24	
319	1152i25	
320	1080i25	
321	1080i24	
322	1080i29	

323	1080i30	
324	1080p24	
325	1080p24	
326	1080p25	
327	1080p29	BNC (YPbPr)
328	1080p30	
329	1080p50	
330	1080p59	
331	1080p60	
332	480i24	
333	480p60	
334	1080i30	
335	720p60	
336	1080p59	
341	480i24	HDMI
342	480i24	
343	576i25	
344	480p60	
345	480p59	
346	576p50	
347	720p60	
348	720p50	
349	1080i30	
350	1080i25	
351	1080p50	
352	1080p60	
353	DMT0659	
354	DMT0860	
355	DMT1060	
368	1080p59	
370	720p59	
371	1080p50	
372	1080i25	
373	1080i24	
374	576i25	

375	480i30	
396	720p59	
397	DMT0660	
398	480p60	

Table 13-3 – Format Range per Interface Map	
Interface Number	Interface Name
301 - 309	TV
310 - 331	BNC + S-Video + CVBS (ED/HD)
332 - 336	DVI
341 - 398	HDMI
400 - 499	VGA(HD15) Analog RGB
500 - 599	VGA(HD15) Analog YPbPr

13.5 Selecting a Test Pattern (Image)

A test pattern (image) can be selected by pressing the PATTERN key followed by the number that represents the desired pattern. The following is an example of how you would select a test pattern using the Image Map file shown in Table 13-4 below.

```
PATTERN
001
ENTER
```

This will display the SMPTEBar pattern at the current format and on the current interface. Then the “Previous” and “Next” keys can be pressed to sequence through the pattern list.

Table 13-4 – Example Image Map File	
Image Number	Image Name
001	SmppteBar
002	TVBar100
003	TVBar_75
004	H_Stair
005	Pluge
100	Ramp
101	SplitGray
200	LG_V_CBAR
300	EcoFlower
301	Halation
302	Loading
400	Flat

401	Flat93
402	Flat87
403	Flat80
404	Flat73
405	Flat67
406	Flat60
407	Flat53
500	PRN24Bit

13.6 Programming a Test Sequence using the keypad

You can create and run test sequences in one of two ways.

- You can program a test sequence through the keypad using the procedures below.
- You can create a sequence by adding a set of commands to the UserKeys.txt file using the procedures below.

Keypad functions are assigned as shown in Table 13-5 below:

Table 13-5 – Keypad Functions	
Key	Function
Num Lock	TIMING - Select a format
/	PATTERN - Select an image
*	Program PROG – Create a sequence
. or Del	OUT or END
-	Go to Previous item
+	Go to NEXT item

1. Define a sequence as follows:

Note: Information after “//” are comments to help you understand.

```

OUT          // press the OUT key to start the creation of the sequence
001         // enter the sequence number
PROG        // press the PROG key to begin programming
TIMING
344         // 480p60 HDMI
PATTERN
001         // SmpteBar pattern
NEXT
TIMING
347         // 720p60 HDMI
PATTERN
004         // horizontal stair
NEXT
TIMING
    
```

```

352          // 1080p60 HDMI
PATTERN
100          // ramp
END          // press the END key to halt the of sequence programming

```

2. Play back a sequence as follows.

```

OUT
001
NEXT
NEXT
(repeat NEXT or PREVIOUS)

```

13.7 Programming a Test Sequence in the UserKeys file

You can also create a test sequence by including a set of commands in the UserKeys.txt file. The UserKeys.txt file is primarily used internally for mapping the keypad keys to a set of commands for general keypad use. However you can also use the UserKeys.txt file to store programming test sequences similar to macros.

The following is an example of a UserKeys.txt file which shows the keypad mapping and more importantly a test sequence instruction set (#F0, #F1 and #FF). Note that there are two macro test sequences defined #F0 and #F1. The #FF definition is a macro that simply disables manufacturing mode in the 804 test instrument. The #F0 macro also shows a special use case for the kbrd command. In this case the kbrd f0 command will cause the macro to loop back on itself such that the #F0 macro continuously loops.

Note: Do not change any of the keypad mapping commands. These are the commands such as xkpm, xkpkj, xkpu, xkpi. Modifying these commands will affect the general functions of the keypad.

```

S xkpm 2
T xkpm 1
U xkpm 4
V xkpj 1
W xkpj -1
X xkpu
Y xkpi 1
Z xkpi 2
[ xkpi 3
\ xkpi 4
] xkpi 5
^ xkpi 6
_ xkpi 7
` xkpi 8
a xkpi 9
b xkpi 0
c xkpm 3

#F0 xvsi 4;fmtl 720p60;imgl smptebar;fmtu;dlay 5000;fmtl 480p60;imgl
h_stair;fmtu;dlay 5000;fmtl 1080i30;imgl needle;fmtu;dlay 5000;fmtl
1080p60;imgl decodchk;fmtu;dlay 5000;fmtl 480i30;imgl v_3bars;fmtu;dlay
5000;kbrd f0

#F1 xvsi 4;fmtl cvt1460d;imgl checkby6;fmtu;dlay 5000;fmtl dmt1170_;fmtu;dlay
5000;fmtl dmt0660;fmtu;dlay 5000

#FF mfgm 0

```

To run a test sequence macro stored in the UserKeys.txt file you use the kbrd command on the command line as follows.

```
KBRD F0    // This command would run the F0 macro in the UserKeys.txt file  
           (case is not important)
```

14 Upgrading the 780C

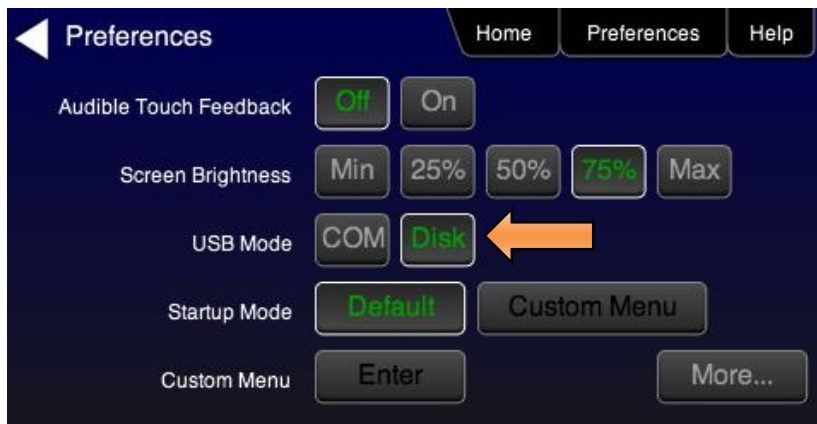
14.1 Upgrading the Firmware and Gateware on your 780C Handheld Test Instrument for HDMI

You can upgrade the firmware and gateware on your 780C through the USB interface. In order to upgrade the 780C firmware and gateware you have to put the 780C in the “Disk” mode. This is not the default mode.

Important Note: Be sure to check the Release Notes on the Quantum Data website for additional information on upgrading for a particular release. The instructions below may not apply in all upgrade scenarios. If you have any questions or encounter a problem with the upgrade, contact Quantum Data customer support.

Use the following procedure to upgrade the firmware and gateware for your 780C. Note that the files will also come with a bootstrap.bin file.

1. Download the 780C firmware and gateware (if necessary) files from the Quantum Data website <http://www.quantumdata.com/downloads/index.asp> to your PC and unzip the file.
2. Connect the 780C to a PC host via the USB cable provided.
3. Touch select the **Preferences** from the 780C top menu.
4. Choose **Disk** for the **USB Mode** (refer to the screen below).



5. Power cycle the 780C.
The 780C appears as a mass storage device like any other USB drive.
6. Transfer the bootstrap.bin from your PC to the 780C using standard Windows drag and drop techniques.
7. Transfer the new firmware (VP500app.bin) from your PC to the 780C using standard Windows drag and drop techniques.
8. (if necessary) Transfer the new gateware file (for 780: Xilinx.bin; for 780C: 780afpga.bin) from your PC to the 780C using standard Windows drag and drop techniques.
9. Use Windows Eject function on the 780C USB device then physically disconnect the 780C from your PC.
10. Reboot the 780C.
11. Navigate to the Help window.



- 12. Activate the gateway (if you are updating the FPGA Flash) by touching the associated **Update** button. A confirmation prompt is displayed. Touch select **Confirm** to initiate the firmware upgrade. (**Note:** The screen on your unit may appear slightly different.)



The screen will show several messages indicating the progress of the update. Once the gateway update has completed the following screen appears.



- 13. Reboot the 780C by power cycling.
- 14. Navigate back to the **Help** menu to access the upgrade screen.
- 15. Activate the firmware (Application Flash) by touch selecting the associated **Update** button. A confirmation prompt is displayed as shown below. Touch select **Confirm** to initiate the firmware upgrade.



The screen will show several messages indicating the progress of the update. Once the firmware update has completed the following screen appears.



- 16. Reboot the 780C by power cycling.
- 17. Touch select the **Preferences** from the 780C top menu.
- 18. Choose **COM** for the **USB Mode** (refer to the screen below).



- 19. Power cycle the 780C.
- 20. Navigate back to the Help menu to verify the upgraded versions.

END OF USER GUIDE