

Spurious Emission Measurement on 5G NR Base Station Transmitters and Receivers

APPLICATION NOTE



Introduction

Conducting spurious emission tests are an important measurement for cellular base station transmitters and receivers on most wireless transmission technologies. The 5G New Radio (NR) refreshed 3GPP specifications based on LTE (long term evolution) by providing faster speed, lower latency, and more spectrum bands to increase network capacity and coverage. With these new complex technologies and requirements, testing RF transmitters and receivers of base stations for spurious emissions is also more challenging.

Spectrum analyzers with high dynamic range are used to execute the spurious scan test. Different than other transmitter tests, spectrum analyzers used for spurious tests also need a wider frequency range coverage beyond just within the transmission band. 3GPP specifies the spurious emission test should be tested up to 12.75 GHz or the 5th harmonic for some frequency bands. This application note discusses how to use Tektronix real-time spectrum analyzers to perform spurious tests on 5G NR base stations.

Understanding the Standards

Spurious emission measurement requirements of the base stations of 5G NR are described in 3GPP TS 38.104.

Requirements about the spurious measurement limit are also included in these subchapters:

- Chapter 6: Conducted transmitter characteristics
 - 6.6.5 Transmitter spurious emissions
- Chapter 7: Conducted receiver characteristics
 - 7.6 Receiver spurious emissions
- Chapter 9: Radiated transmitter characteristics
 - 9.7.5 OTA transmitter spurious emissions
- Chapter 10: Radiated receiver characteristics
 - 10.7 OTA receiver spurious emissions

5G OPERATING FREQUENCY BANDS

The frequency ranges that NR can operate in, according to the current specification version (3GPP TS 38.104 V15.2.0 2018-06), are identified as:

Frequency range designation	Corresponding frequency range
FR1	450 MHz – 6 GHz
FR2	24.25 GHz – 52.6 GHz

Different countries are working on different frequency bands. The difficulties associated with mm wave means standards organizations and mobile operators will continue to rely heavily on the sub-6 GHz (FR1) spectrum. Therefore, FR1 is a more immediate solution for now. For example, 3.5 GHz is the most popular band added in 5G NR. For this band, the 12.75 GHz upper frequency limit isn't enough for the spurious emission test. The 5th harmonic, up to 18 GHz, needs to be covered in these tests.

TEST REFERENCE POINTS

Unlike previous generations of cellular network standards, which were deployed as standalone networks, 5G NR is designed to interwork fully with existing 4G LTE networks. Therefore, compared to a test configuration of 4G LTE, 5G NR kept the traditional ways of conducted tests. This type of base station is called BS type 1-C in 3GPP standard.

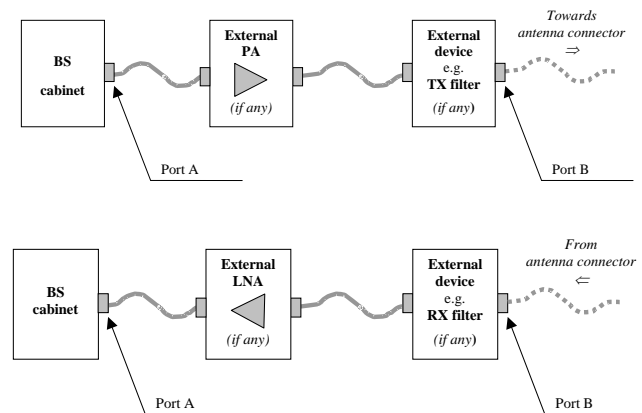

Figure 1: BS type 1-C transmitter receiver interface [1]

However, 5G will also utilize multiple antennas for massive MIMO and beam steering. The highly integrated ICs have no place to probe or put connectors for testing. A consequence of the integration is it has become impractical to use traditional conducted ways for RF testing, bringing the need for OTA (over the air) testing.

Three new types—BS type 1-H, 1-O, and 2-O—have been added for OTA hybrid operation for different frequency bands.

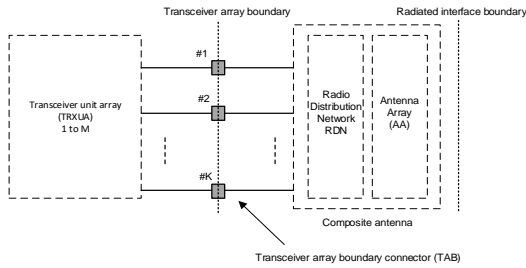

Figure 2: Radiated and conducted reference points for type 1-H [1]

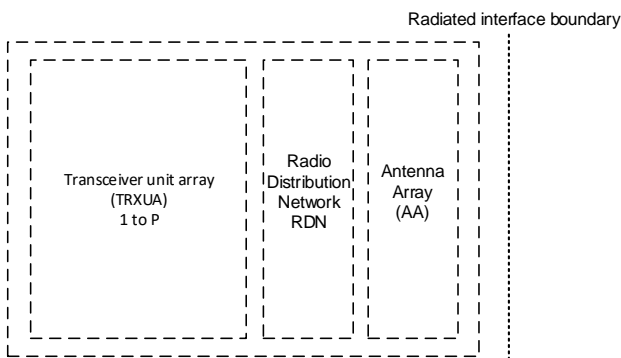

Figure 3: Radiated reference points for type 1-O (sub 6 GHz bands) and type 2-O (mm-wave bands) [1]

UNWANTED EMISSION FREQUENCY RANGE

Transmitter test frequency ranges on the 3GPP physical layer are different depending on specific tests. Both in-channel and out-of-channel areas need to be checked. Figure 4 shows the classification of tests based on frequency domains.

Most modulation analysis or in-band power checks are within the channel bandwidth. Unwanted emissions start from 9 kHz to the lower frequency edge of the channel and then from the higher edge of the channel up to 12.75 GHz or the 5th harmonic of the operating frequency.

Unwanted emissions include four test items:

- occupied bandwidth
- adjacent channel leakage power ratio (ACLR)
- operating band unwanted emissions
- spurious emissions

Figure 5 provides the frequency boarder definitions of each test item.

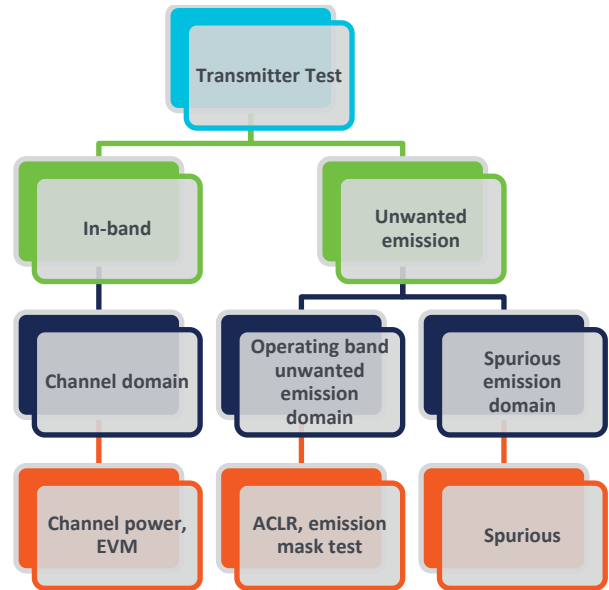

Figure 4: Frequency domain categories of 5G NR transmitter tests

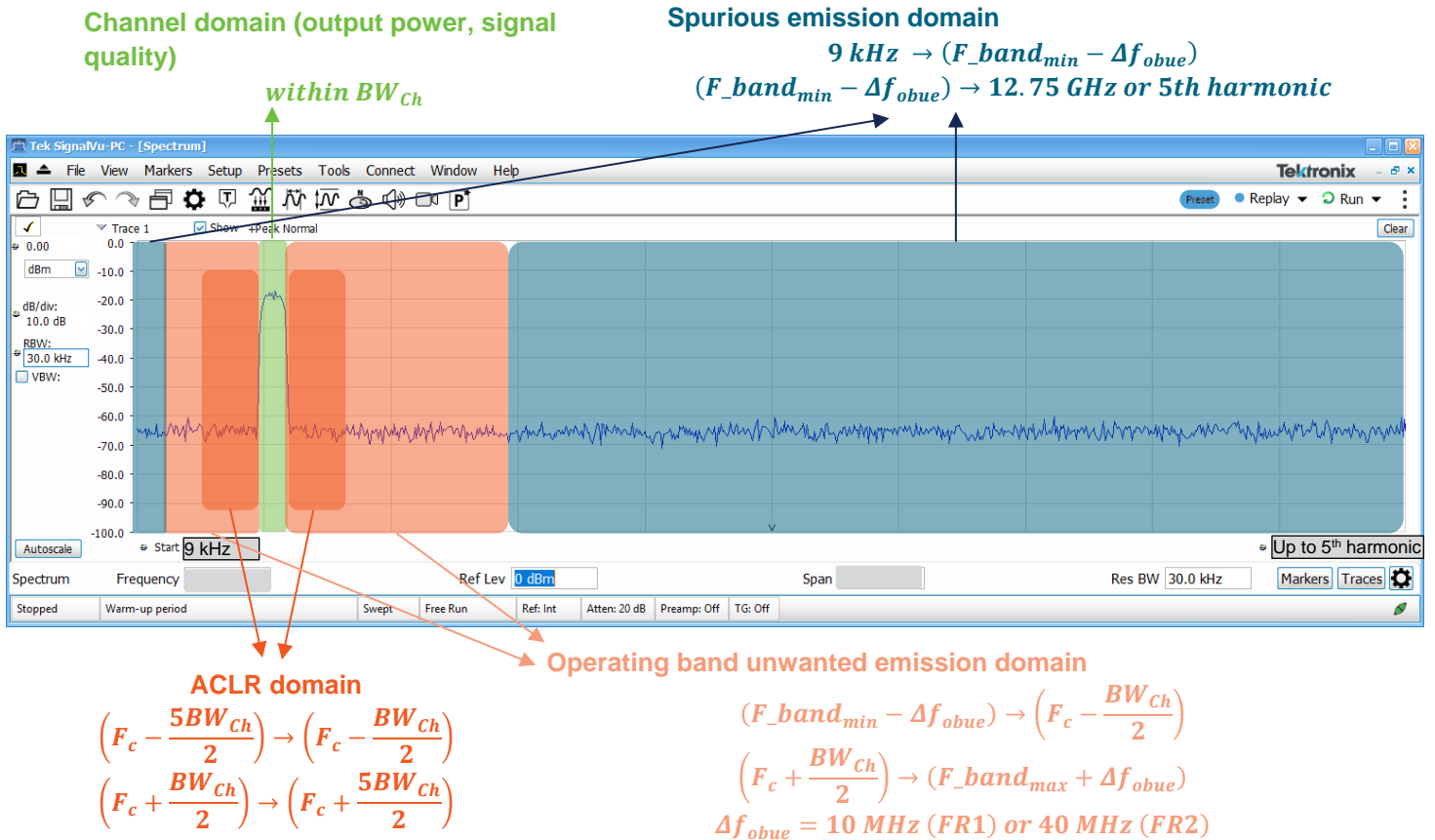

Figure 5: The frequency ranges of different transmitter measurements

GENERAL REQUIREMENTS

Once the test frequency range is clear, we will zoom in the spurious test requirements for 5G. The spurious emission tests usually have a general requirement.

Conducted methods: For spurious transmitter tests, two limits categories are defined. Category A limits (Table 1) are the attenuation values that calculate maximum permitted spurious domain emission power levels. Category B limits (Table 2) are more stringent spurious domain emission limits than Category A limits. They are based on limits defined and adopted in Europe and other countries.

For spurious receiver tests, only one limit table applied as general limits (Table 3).

Spurious frequency range	Basic limit	Measurement bandwidth
9 kHz – 150 kHz	-13 dBm	1 kHz
150 kHz – 30 MHz		10 kHz
30 MHz – 1 GHz		100 kHz
1 GHz – 12.75 GHz		1 MHz
12.75 GHz – 5 th harmonic of the upper frequency edge of the operating band in GHz		1 MHz

Table 1: Conducted BS spurious emission limits in FR1, Cat A

Spurious frequency range	Basic limit	Measurement bandwidth
9 kHz – 150 kHz	-36 dBm	1 kHz
150 kHz – 30 MHz		10 kHz
30 MHz – 1 GHz		100 kHz
1 GHz – 12.75 GHz		1 MHz
12.75 GHz – 5 th harmonic of the upper frequency edge of the operating band in GHz		1 MHz

Table 2: Conducted BS spurious emission limits in FR1, Cat B

Frequency range	Basic limits	Measurement bandwidth
30 MHz – 1 GHz	-57 dBm	100 kHz
1 GHz – 12.75 GHz	-47 dBm	1 MHz
12.75 GHz – 5 th harmonic of the upper frequency edge of the UL operating band in GHz	-47 dBm	1 MHz

Table 3: General RX spurious emissions limits

Radiated methods: The spurious emission limits of radiated test methods are calculated from the limits of the conducted methods.

- BS type 1-O: The total radiated power (TRP) of any spurious emission shouldn't exceed an OTA limit, specified as the basic limit of the conducted requirements + X, where X = 9 dB, unless stated differently in regional regulation. This rule applies to both transmitter and receiver tests.

FR2: The OTA transmitter spurious emission limits apply from 30 MHz to 2nd harmonic of the upper frequency edge of the downlink operating band, as seen in Table 4.

Frequency range	Limit	Measurement Bandwidth
30 MHz – 1 GHz	-13 dBm	100 kHz
1 GHz – 2 nd harmonic of the upper frequency edge of the DL operating band		1 MHz

Table 4: BS radiated TX spurious emission limits in FR2

Table 5 shows the receiver requirements for FR2.

Frequency range	Limit	Measurement bandwidth
30 MHz – 1 GHz	-57 dBm	100 kHz
1 GHz – 12.75 GHz	-47 dBm	1 MHz
12.75 GHz – 2 nd harmonic of the upper frequency edge of the UL operating band	-36 dBm	1 MHz

Table 5: Radiated RX spurious emission limits for BS type 2-O

ADDITIONAL REQUIREMENTS

There are some additional requirements to protect the base stations or other systems.

Protection of the BS receiver from own or different BS: This requirement applies to NR FDD operation in order to prevent BS receivers becoming desensitized by emissions from a BS transmitter.

BS class	Frequency range	Basic limit	Measurement bandwidth
Wide Area BS	F _{UL_low} – F _{UL_high}	-96 dBm	100 kHz
Medium Range BS	F _{UL_low} – F _{UL_high}	-91 dBm	100 kHz
Local Area BS	F _{UL_low} – F _{UL_high}	-88 dBm	100 kHz

Table 6: BS spurious emissions limits for the protection of BS receivers

For OTA test, the total power of any spurious emission from both polarizations of the co-location reference antenna connector output shouldn't exceed the basic limits in Table 6 + X dB, where X = -21 dB.

Additional regional requirements: Additional requirements may be applied for the protection of a system operating in frequency ranges other than the BS downlink operating band. Further details can be found in 3GPP TS 38.104, 6.6.5.2.3, and 6.6.5.2.4.

Performing the Measurements

MEASUREMENT SETUP

Spurious measurements of 5G NR or other wireless communication systems can be performed with the Tektronix spectrum analyzer standalone without additional notch filters. Setting up the spurious tests in Tektronix real time spectrum analyzers or SignalVu-PC vector signal analysis software is possible in five steps.

Step 1: Spur Search preset

SignalVu-PC includes standard configurations tailored to specific applications or analysis types. The Spur Search application preset sets the analyzer to display spurs that exceed the Threshold and Excursion values for the default frequency range.

Step 2: Edit or load the limit table

The limit line of the spurious search can be edited based on the standard, or users can recall the csv files we provided for the 5G spurious tests.

Step 3: Bypass the operating frequency band

The test usually requires a notch filter that suppresses the frequency range of the 5G carrier on the base station. However, the RSA series features multi-range spurious measurements, sweeping through only the frequency ranges of interest, and skips over the transmission band to prevent overload.

Step 4: Optimize the test

The RF attenuation must be set to the minimum possible value that doesn't result in compression of the analyzer signal path. The preamplifier in the spectrum analyzer is also useful to handle the low power signals in order to reach the required sensitivity for this measurement. Scale can be set to linear or log.

Step 5: Run the test

Run the scan. The pass/fail sign will be shown and the violated spurs listed in the result table.

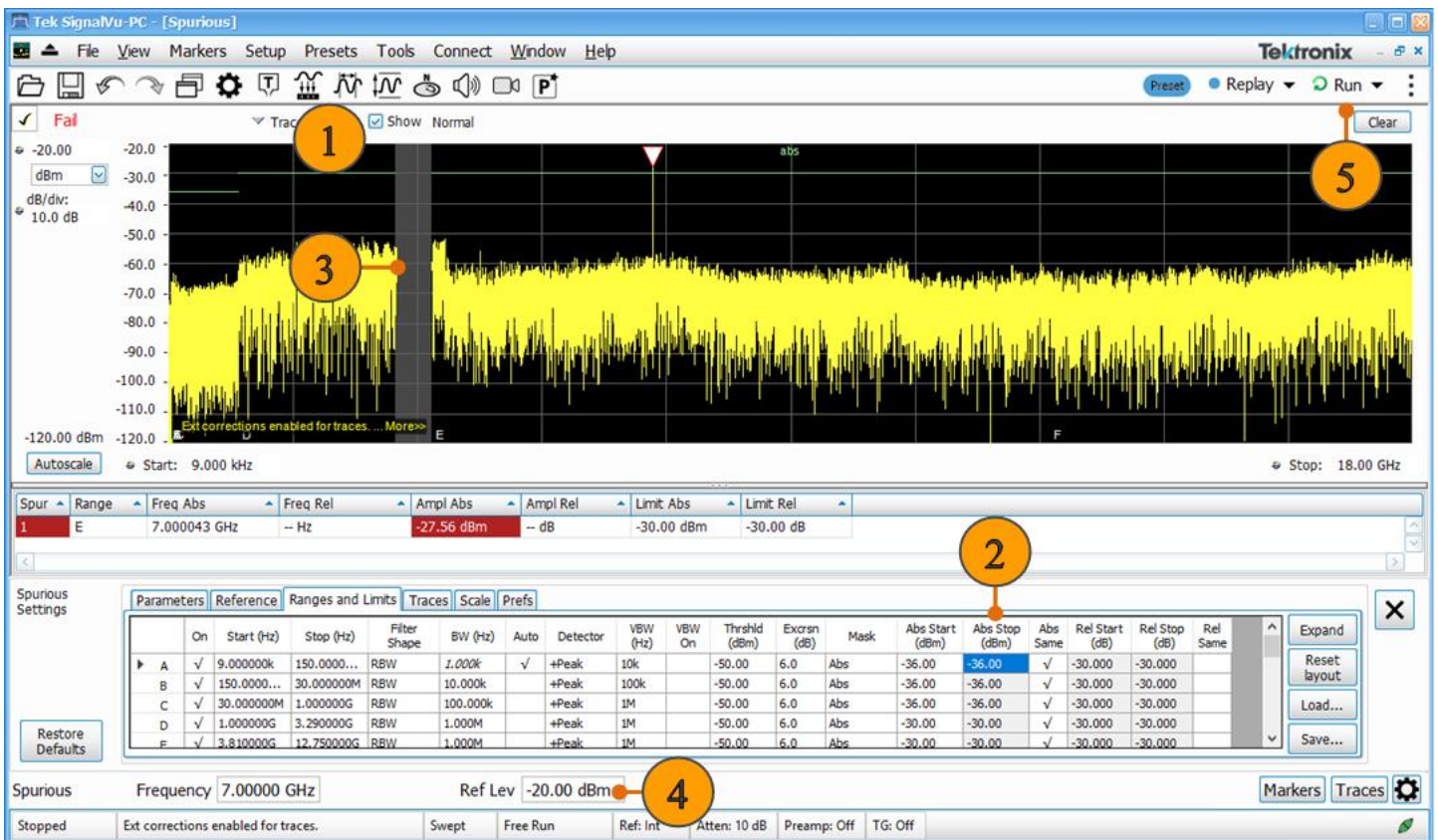

Figure 6: The spurious emission test of a 5G BS transmitter in FR1 category B using RSA518A

Troubleshooting with DPX real time analysis

Once issues have been found in spurious emission tests, you may need to troubleshoot the issues and locate the sources of RF emissions. Real-time DPX® technology in Tektronix spectrum analyzers can help discover the most difficult, hard-to-find problems by seeing RF characteristics invisible to a conventional spectrum analyzer. Figure 7 shows the DPX spectrum versus regular spectrum displays. The DPX spectrum indicates regularly occurring spurs, even though they are hidden below wideband noise.

Summary

Spurious emission tests are one of the most demanding measurements on 5G NR base station transmitters. The new radios in the 5G standard make the tests more complicated. This application note summarizes the test requirements of spurious emission tests of 5G NR base stations and provides guidance on how to perform the tests. Tektronix real time spectrum analyzer RSA518A provides high dynamic range and a multi-range scan feature up to 18 GHz, which helps make troubleshooting much easier.

References

- [1] "3GPP release 15 38.104 NR; Base Station (BS) radio transmission and reception," [Online].

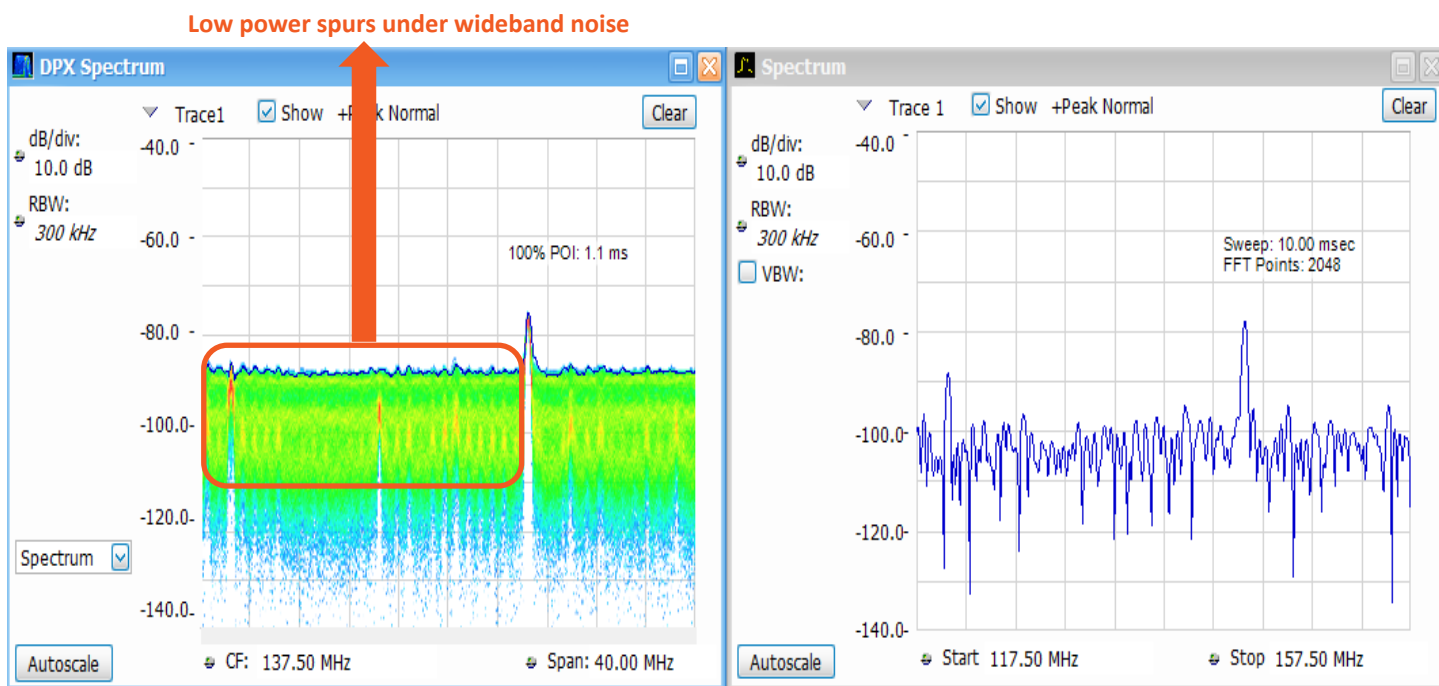

Figure 7: DPX real time spectrum analysis vs. regular swept spectrum analysis. DPX can detect transient signals and helps users gain insights of co-channel interference

Contact Information:

Australia 1 800 709 465
Austria 00800 2255 4835
Balkans, Israel, South Africa and other ISE Countries +41 52 675 3777
Belgium 00800 2255 4835
Brazil +55 (11) 3759 7627
Canada 1 800 833 9200
Central East Europe / Baltics +41 52 675 3777
Central Europe / Greece +41 52 675 3777
Denmark +45 80 88 1401
Finland +41 52 675 3777
France 00800 2255 4835
Germany 00800 2255 4835
Hong Kong 400 820 5835
India 000 800 650 1835
Indonesia 007 803 601 5249
Italy 00800 2255 4835
Japan 81 (3) 6714 3010
Luxembourg +41 52 675 3777
Malaysia 1 800 22 55835
Mexico, Central / South America and Caribbean 52 (55) 56 04 50 90
Middle East, Asia, and North Africa +41 52 675 3777
The Netherlands 00800 2255 4835
New Zealand 0800 800 238
Norway 800 16098
People's Republic of China 400 820 5835
Philippines 1 800 1601 0077
Poland +41 52 675 3777
Portugal 80 08 12370
Republic of Korea +82 (2) 565-1455
Russia / CIS +7 (495) 6647564
Singapore 800 6011 473
South Africa +41 52 675 3777
Spain 00800 2255 4835
Sweden 00800 2255 4835
Switzerland 00800 2255 4835
Taiwan 886 (2) 2656 6688
Thailand 1 800 011 931
United Kingdom / Ireland 00800 2255 4835
USA 1 800 833 9200
Vietnam 12060128

Find more valuable resources at TEK.COM

Copyright © 2016, Tektronix. All rights reserved. Tektronix products are covered by U.S. and foreign patents, issued and pending. Information in this publication supersedes that in all previously published material. Specification and price change privileges reserved. TEKTRONIX and TEK are registered trademarks of Tektronix, Inc. All other trade names referenced are the service marks, trademarks or registered trademarks of their respective companies.

[11-18] [37W-61489-0]

