

# USB 2.0 Electrical Compliance Testing Software for 5/6 Series MSO

## Option 5-CMUSB2/6-CMUSB2 Datasheet

*Get more visibility into your USB designs*



USB 2.0 is a widely used system bus, due to its reliability and cost-effectiveness. The bus uses differential signaling and its bit rate ranges from 1.5 Mb/s (low speed) to 480 Mb/s (high speed). To ensure that USB 2.0 implementations are robust and interoperable, the standard defines a series of tests, including mask testing and parametric testing of low-speed, full-speed, and high-speed for devices, hosts, and hubs. This datasheet describes TekExpress USB2 Electrical Compliance testing software (option 5-CMUSB2/6-CMUSB2) for the 5/6 Series MSO, which automates the standard tests.

Even without the USB2 Electrical Testing Software option, the 5/6 Series MSO offers a versatile range of signal analysis tools for design validation and debug.

It is recommended to perform an in house compliance testing of the measurements using the USB2.0 Electrical Compliance testing software (5/6-CMUSB2) to identify and address the potential USB 2.0 design issues and then send the product for a formal certification. This reduces the product failure risk at the USB workshop or at the test house. This can save time, reduce the expenses and also identify specification conditions.

The USB Implementers Forum, Inc. (USB-IF) defines a suite of tests that determine compliance with the USB 2.0 standard. The goal of the testing is to confirm a design's reliability and compatibility. Designers must pass all compliance tests recommended by the USB-IF to use the USB-IF logo on their packaging. However, many designers also use the tests to perform validation and margin testing, thereby increasing confidence in their designs.

Manually performing the standard tests is difficult and requires significant expertise, but the 5/6 Series MSO, equipped with Option 5-CMUSB2/6-CMUSB2, facilitates testing by handling oscilloscope setup, automating tests, evaluating pass/fail results, and report generation. The option is built on the proven TekExpress® automated serial compliance testing platform.

### Design validation and debug

Testing the design can easily be accomplished early in the design process and ahead of final certification testing by using the 5/6 Series MSO oscilloscope. The oscilloscope's standard measurement set, along with the optional 5-DJA/6-DJA Advanced Jitter and Timing Analysis software supports several of the key compliance tests including:

- Eye diagram analysis of USB signals
- Full characterization of jitter performance including TIE and histogram profiles
- Rise and fall time analysis

Eye pattern analysis is a proven technique to evaluate long data streams of complex communication signals. Eye pattern display is standard in the 5/6 Series MSO, but Advanced Jitter and Eye Analysis software (option 5-DJA/6-DJA) provides 31 additional measurements and jitter decomposition algorithms to help get to root cause.

Tektronix also offers an optional 5-SRUSB2 and 6-SRUSB2 decode and trigger solution to perform USB specific protocol level analysis on the design.

Using the signal analysis and protocol decoder increases the likelihood of passing compliance tests, and can provide broader insight beyond the standard compliance tests.

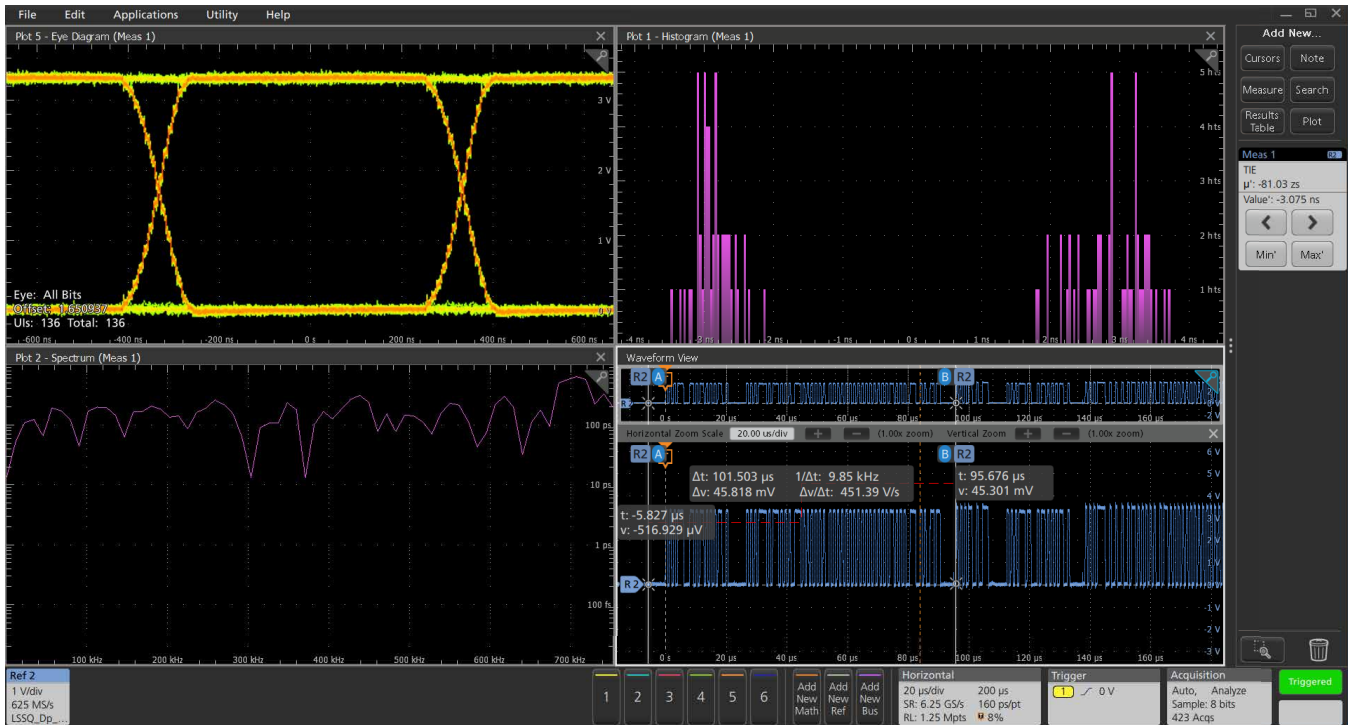

Detailed analysis of a USB 2.0 signal using the 5/6 Series MSO measurement plots and optional Advanced Jitter Analysis (5-DJA/6-DJA) measurements

## Automated USB 2.0 testing with option 5-CMUSB2/6-CMUSB2

USB 2.0 electrical testing requires an oscilloscope with minimum bandwidth of 2 GHz. TekExpress USB2 software for the 5/6 Series MSO (5-CMUSB2/6-CMUSB2) provides automated compliance testing for USB 2.0 serial bus verification, including:

- High-speed tests: Signal Quality, Receiver Sensitivity, Chirp, Reset, Reset from High Speed, Reset from Suspend, Resume, and Suspend
- Eye diagram, Jitter, Rise time, Fall time, and EOP width
- Packet Parameter and Monotonicity
- Power measurements: Droop and Inrush current

TekExpress USB2 supports Device, Host, and Hub test suites and each suite includes approximately 50 measurements. Executing all the measurements manually is extremely time-consuming. TekExpress USB2 software has an automation framework built around these measurements, so that you can execute all the measurements with fewer clicks and intervene only to change connections.

TekExpress USB2 software allows you to select complete or selective testing of any of the transmitter electrical specifications. Tests are configured by following a step-by-step process. The software sets up the oscilloscope and automates the testing, guiding you to accurate and repeatable results. It generates a comprehensive, date-stamped test report with pass/fail results, waveforms, and data plots.

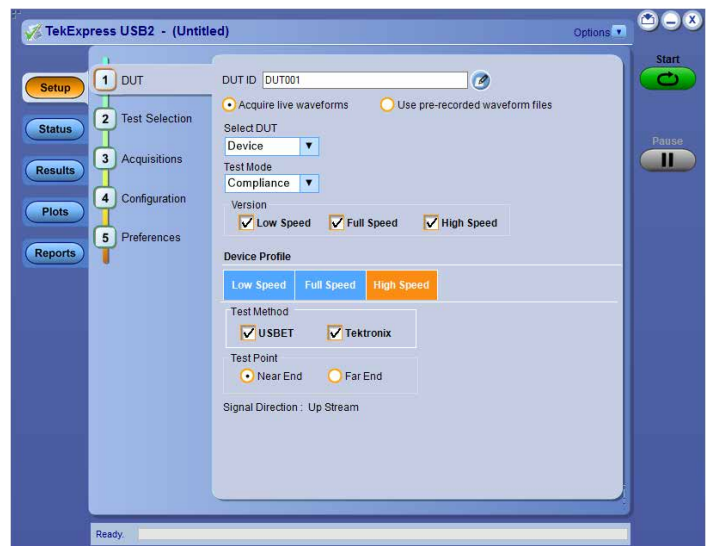

TekExpress USB2 DUT panel configures the DUT specific settings

Software navigation follows a logical workflow for quick test setups, changes and review of test results. Valid testing requires proper cabling, probes, and connections between fixtures, instruments, and the device under test (DUT). The software provides setup instructions for each test, with images and reference illustrations showing correct configurations.

Host High Speed Signal Quality

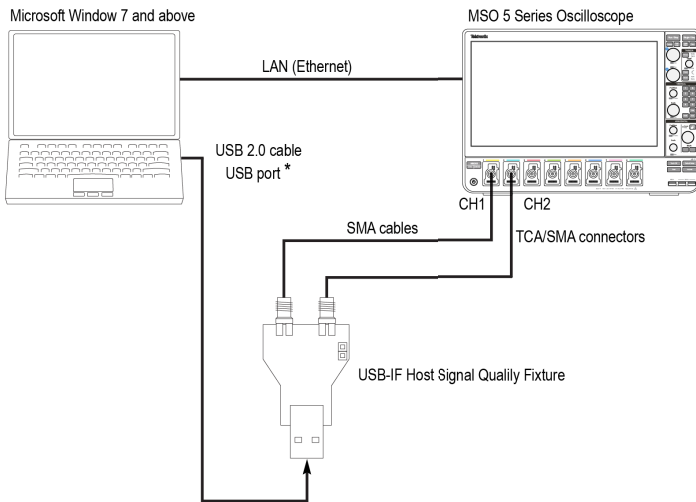

\* Requires EHCI or XHCI controller.

0867-019

Typical USB 2.0 setup configuration

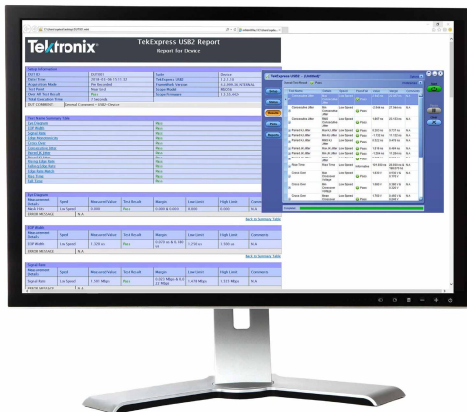

TekExpress USB2 software requires a Tektronix 5/6 Series MSO oscilloscope with Option 5-WIN/6-WIN or SUP5-WIN/SUP6-WIN (Microsoft Windows 10). This is a Windows application and the software displays TekExpress USB2 software and test reports on the oscilloscope display. However, for convenience an external monitor may be connected to the 5/6 Series MSO so test controls and reports can be viewed on the external display, while signal acquisition is observed on the primary oscilloscope display.

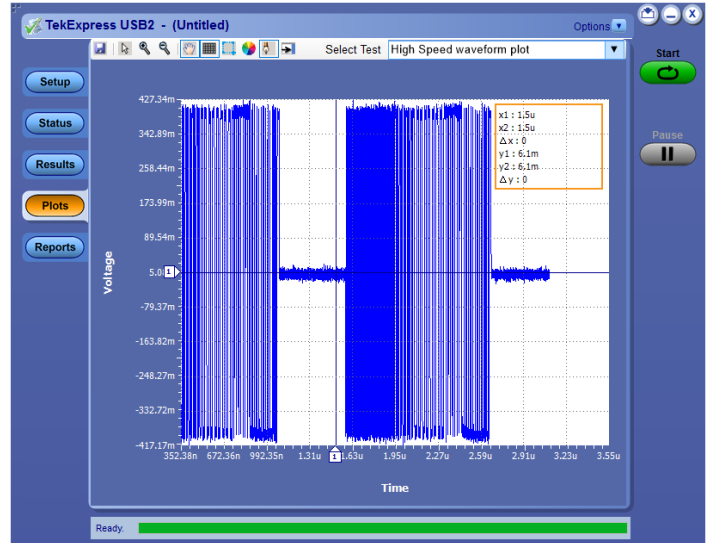

Displaying the high speed signal quality plot during execution

For each test, the DUT must be placed in specific operating modes using industry standard HS electrical test tool software (USBHSET.exe) from the USB Implementers Forum, Inc (USB-IF). The USBHSET tool runs on a Windows PC. The PC can be connected to the 5/6 Series MSO via LAN (Ethernet), allowing TekExpress USB2 to communicate with the USBHSET tool to automatically put the DUT in the correct mode for each test.

For each test or series of tests, you select the test of interest. The TekExpress software shows you how to configure the DUT with proper test fixtures, cables or probes. You initiate the test and the software performs all the necessary instrument setups and prompts you only when needed. Quick Pass/Fail tests substantiated with results makes USB 2.0 application the preferred solution for USB 2.0 physical-layer validation. The user-defined measurement limits and custom-mask testing also helps you to perform tolerance testing.

Test Name	Details	Speed	Pass/Fail	Value	Margin	Comments
Eye Diagram	Mask Hits	High Speed	Pass	0.000	0.000 & 0.000	N.A
EOP Width	EOP Width	High Speed	Pass	7.9 bits	0.400 bits & 0.600 bits	Measured Value = 16.46 ns
Signal Rate	Signal Rate	High Speed	Pass	480.057 Mbps	0.297 Mbps & 0.183 Mbps	N.A
Edge Monotonicity	Edge Monotonicity	High Speed	Pass	0.000 mV	50.000 mV	N.A
Rising Edge Rate	Rising Edge Rate	High Speed	Pass	1341.260 V/us	791.740 V/us	N.A
Falling Edge Rate	Falling Edge Rate	High Speed	Pass	1336.500 V/us	796.500 V/us	N.A
Rise Time	Rise Time	High Speed	Pass	477.160 ps	177.160 ps	N.A
Fall Time	Fall Time	High Speed	Pass	478.860 ps	178.860 ps	N.A
Consecutive Jitter	Max Consecutive Jitter	High Speed	Informative	73.477 ps	N.A	N.A
Consecutive Jitter	Min Consecutive Jitter	High Speed	Informative	-87.204 ps	N.A	N.A
Consecutive Jitter	RMS Consecutive Jitter	High Speed	Informative	34.541 ps	N.A	N.A
Paired JK Jitter	Max JK Jitter	High Speed	Informative	54.302 ps	N.A	N.A
Paired JK Jitter	Min JK Jitter	High Speed	Informative	-68.293 ps	N.A	N.A

Jitter measurement results displayed in a table, along with limits and margin

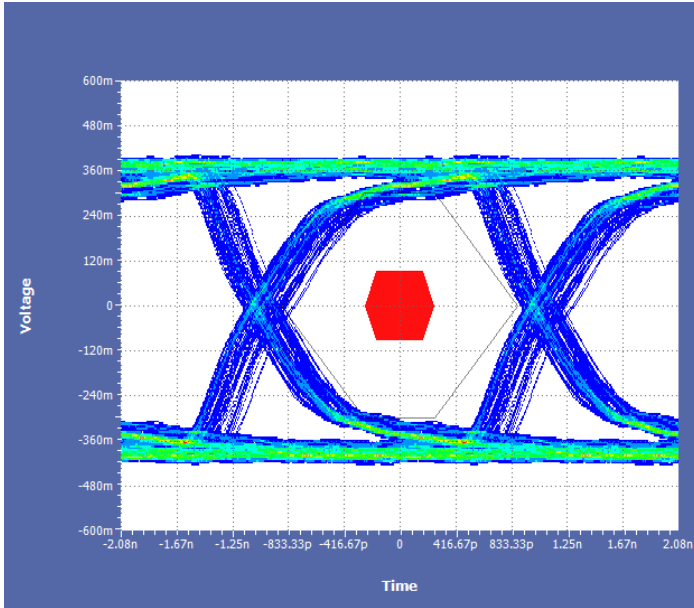

Custom Mask (red) with standard USB-IF mask (black) as reference

The TekExpress USB2 application has a dedicated Plots panel, which helps you to analyze eye diagrams and signal quality. The panel also allows you to place cursors, zoom into the plot and save the plot as an image. This allows you to perform eye diagram analysis with custom masks and evaluate device margins.

### Pass/fail reports

Creating test documentation is quick and easy with summary reports available in MHTML, CSV, or PDF formats. The report is generated automatically when the test execution is complete and provides Pass/Fail status for measurements. The report also includes test configuration details, waveform plots, oscilloscope displays and margin analysis, to provide more insights into your design.

### Tektronix® TekExpress USB2 Report

Report for Hub

Setup Information			
DUT ID	DUT001	Suite	Hub
Date/Time	2018-03-13 17:10:30	TekExpress USB2	1.2.1.10
Acquisition Mode	Live	FrameWork Version	4.3.999.36_INTERNAL
Test Point	Near End	Scope Model	MSO56
Port Number	1	Scope Firmware	1.3.55.4424
Probing	Single Ended only		
Over All Test Result	Pass		
Total Execution Time	21 Seconds		
DUT COMMENT:	General Comment - USB2-Hub		

Test Name Summary Table	
Eye Diagram	Pass

Eye Diagram Measurement Details	Speed	Measured Value	Test Result	Margin	Low Limit	High Limit	Comments
Mask Bits	Low Speed	0.000	Pass	0.000 & 0.000	0.000	0.000	N.A

ERROR MESSAGE: N.A

[Back to Summary Table](#)

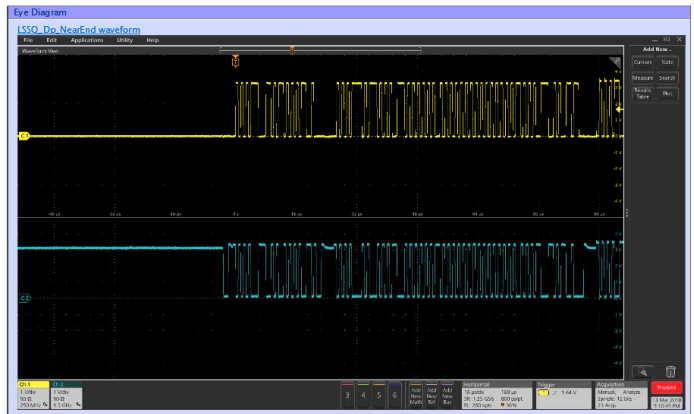

TekExpress USB2 report showing setup details and measurement results

### Probing and test fixtures

The following probes are recommended for USB 2.0 testing:

- Differential probes: P6248, TDP1500, and TDP3500
- Single-ended probes: P6245, TAP1500, and TAP2500
- Current probe for Inrush current test: TCP0030A

Fixtures provide connection points for USB 2.0 electrical testing.

Refer to [Ordering Information](#) for recommended test fixtures.

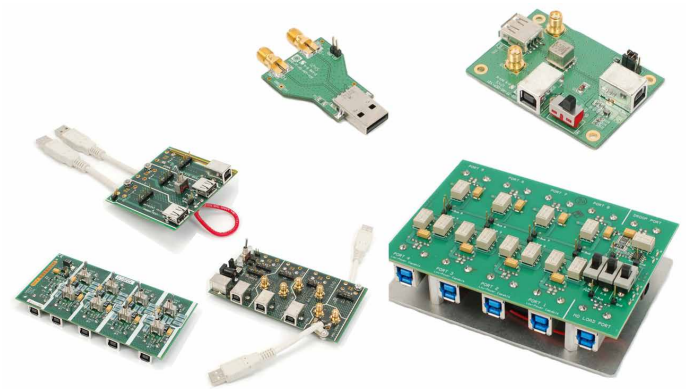

USB 2.0 test fixture set

## Specifications

<b>USB tests</b>	Host, Hub, and Device
<b>Signal Quality tests</b>	Eye Diagram Test, Jitter (JK, KJ, and Consecutive), Crossover Voltage Range, Signal Rate, End-of-Packet Width, Rising Edge Rate, and Falling Edge Rate
<b>High-speed tests</b>	Receiver Sensitivity, Chirp, Reset, Resume, Reset from High Speed, Reset from Suspend, Packet Parameter, and Edge Monotonicity
<b>Inrush Current check</b>	Data-sufficiency readout. Coulombs and Capacitance listed across inrush regions
<b>Droop test</b>	Volts readout
<b>Speed selection</b>	Low-speed (LS), Full-speed (FS), and High-speed (HS)
<b>Signal direction</b>	Upstream and Downstream
<b>Test Point selection</b>	Near End and Far End
<b>Report Generation format</b>	MHTML, PDF, and CSV formats

## Ordering information

### Product requirements, options and recommended accessories

#### Required hardware

Oscilloscope	5 Series MSO oscilloscope with minimum bandwidth of 350 MHz (option 5-BW-350, 5-BW-500, 5-BW-1000) for Low-speed and Full-speed USB
	6 Series MSO oscilloscope with minimum bandwidth of 1 GHz (option 6-BW-1000, 6-BW-2500, 6-BW-4000, 6-BW-6000, 6-BW-8000) for Low-speed, Full-speed, and High-speed USB
	5 / 6 Series MSO oscilloscope with minimum bandwidth of 2 GHz (option 5-BW-2000) for Low-speed, Full-speed, and High-speed USB
Supported instruments	MSO64, MSO54, MSO56, MSO58, MSO64
Option	5-WIN or SUP5-WIN (removable SSD with Microsoft Windows 10 operating system)
	6-WIN or SUP6-WIN (removable SSD with Microsoft Windows 10 operating system)

#### Required software

Application	Option	License Type
TekExpress USB 2.0 electrical testing software	6-CMUSB2	New instrument license
	5-CMUSB2	New instrument license
	SUP6-CMUSB2	Upgrade license
	SUP5-CMUSB2	Upgrade license
	SUP6-CMUSB2-FL	Floating license
	SUP5-CMUSB2-FL	Floating license

#### Recommended options

Option	Application
6-DJA or SUP6-DJA	Advanced Jitter and Eye Analysis measurements
5-DJA or SUP5-DJA	Advanced Jitter and Eye Analysis measurements
6-SRUSB2 or SUP6-SRUSB2	Automated Trigger and Decode for USB 2.0
Table continued...	

Option	Application
5-SRUSB2 or SUP5-SRUSB2	Automated Trigger and Decode for USB 2.0

**Probing**

**Recommended**

Probes	Quantity
TDP1500 or TDP3500 Differential probe	1
TAP1500 or TAP2500 Single-ended probe	3
TCP0030A Current probe	1

**Supported**

Probes	Quantity
P6248	1
P6245	3

**Signal sources**



**Recommended**

Tektronix AWG5200 signal source

**Supported**

Tektronix AWG5000C, AWG7000C, AWG70000A signal source

**Recommended test fixtures**

Test Fixtures	Vendor
USB 2.0 Std-A/Std-B Electrical Test Fixture	Any USB-IF approved Test Fixture  <b>Note:</b> Please visit <a href="http://www.usb.org">www.usb.org</a> for fixture details.
USB 2.0 Type-C™ Electrical Test Fixture	Any USB-IF approved Test Fixture  <b>Note:</b> Please visit <a href="http://www.usb.org">www.usb.org</a> for fixture details.

**Recommended cables**

SMA to SMA Cable Pair (174-5771-xx)

**Recommended extras**

External PC monitor, USB keyboard, USB mouse

**Additional information**

Tektronix offers a range of solutions for USB testing, including HSIC (High Speed Inter Connect) and USB 3.0. To see a comprehensive listing, and download the latest resources, visit [www.tek.com/usb](http://www.tek.com/usb).

For all probing related information, visit [www.tek.com/probe-selector](http://www.tek.com/probe-selector).

For exploring other supported application and capabilities of latest Tektronix 5 series MSO oscilloscope, visit [www.tek.com/oscilloscope/5-series-mso-mixed-signal-oscilloscope](http://www.tek.com/oscilloscope/5-series-mso-mixed-signal-oscilloscope).

For USB 2.0 standards documents and test procedures, as well as USBHSET software and test fixtures, please visit [www.usb.org/home](http://www.usb.org/home).



Tektronix is ISO 14001:2015 and ISO 9001:2015 certified by DEKRA.

ASEAN / Australasia (65) 6356 3900  
 Belgium 00800 2255 4835\*  
 Central East Europe and the Baltics +41 52 675 3777  
 Finland +41 52 675 3777  
 Hong Kong 400 820 5835  
 Japan 81 (120) 441 046  
 Middle East, Asia, and North Africa +41 52 675 3777  
 People's Republic of China 400 820 5835  
 Republic of Korea +822 6917 5084, 822 6917 5080  
 Spain 00800 2255 4835\*  
 Taiwan 886 (2) 2656 6688

Austria 00800 2255 4835\*  
 Brazil +55 (11) 3759 7627  
 Central Europe & Greece +41 52 675 3777  
 France 00800 2255 4835\*  
 India 000 800 650 1835  
 Luxembourg +41 52 675 3777  
 The Netherlands 00800 2255 4835\*  
 Poland +41 52 675 3777  
 Russia & CIS +7 (495) 6647564  
 Sweden 00800 2255 4835\*  
 United Kingdom & Ireland 00800 2255 4835\*

Balkans, Israel, South Africa and other ISE Countries +41 52 675 3777  
 Canada 1 800 833 9200  
 Denmark +45 80 88 1401  
 Germany 00800 2255 4835\*  
 Italy 00800 2255 4835\*  
 Mexico, Central/South America & Caribbean 52 (55) 56 04 50 90  
 Norway 800 16098  
 Portugal 80 08 12370  
 South Africa +41 52 675 3777  
 Switzerland 00800 2255 4835\*  
 USA 1 800 833 9200

\* European toll-free number. If not accessible, call: +41 52 675 3777

**For Further Information.** Tektronix maintains a comprehensive, constantly expanding collection of application notes, technical briefs and other resources to help engineers working on the cutting edge of technology. Please visit [www.tek.com](http://www.tek.com).

Copyright © Tektronix, Inc. All rights reserved. Tektronix products are covered by U.S. and foreign patents, issued and pending. Information in this publication supersedes that in all previously published material. Specification and price change privileges reserved. TEKTRONIX and TEK are registered trademarks of Tektronix, Inc. All other trade names referenced are the service marks, trademarks, or registered trademarks of their respective companies.